

TOSHIBA BiCD Integrated Circuit Silicon Monolithic

TBD62783APG, TBD62783AFG, TBD62783AFNG, TBD62783AFWG

8channel source type DMOS transistor array

TBD62783A series are DMOS transistor array with 8 circuits. It has a clamp diode for switching inductive loads built-in in each output. Please be careful about thermal conditions during use.

Features

- 8 circuits built-in
- High voltage : $V_{OUT} = 50\text{ V (MAX)}$
- High current : $I_{OUT} = -500\text{ mA (MAX for each channel)}$
- Input voltage(output on): 2.0 V (MIN)
- Input voltage(output off): 0.6 V (MAX)
- Package : PG type P-DIP18-300-2.54-001
 FG type SOP18-P-375-1.27
 FNG type SSOP18-P-225-0.65
 FWG type P-SOP18-0812-1.27-001

Pin connection (top view)

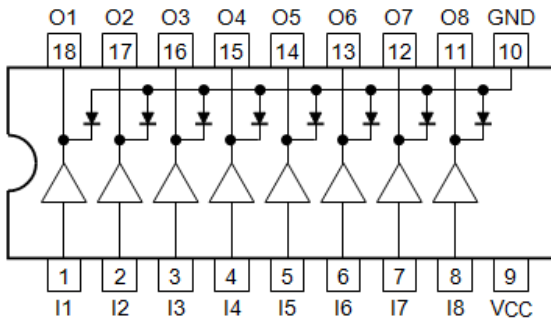

Pin connection may be simplified for explanatory purpose.

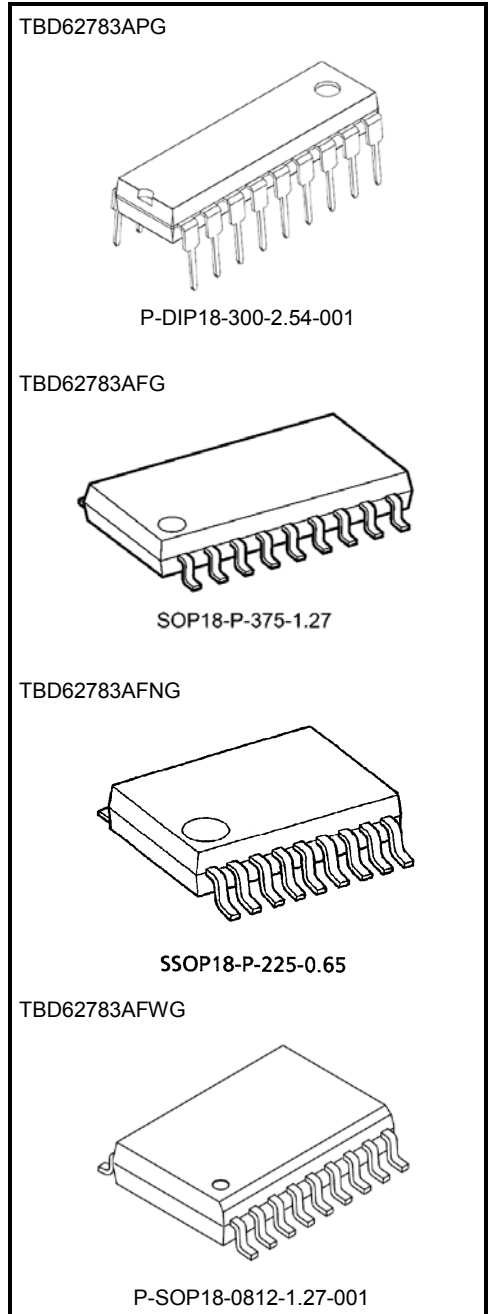

| | |
|-----------------------|----------------|
| Weight | |
| P-DIP18-300-2.54-001 | : 1.3g (Typ.) |
| SOP18-P-375-1.27 | : 0.41g (Typ.) |
| SSOP18-P-225-0.65 | : 0.09g (Typ.) |
| P-SOP18-0812-1.27-001 | : 0.48g (Typ.) |

Pin explanations

| Pin No. | Pin name | Function |
|---------|----------|------------------|
| 1 | I1 | Input pin |
| 2 | I2 | Input pin |
| 3 | I3 | Input pin |
| 4 | I4 | Input pin |
| 5 | I5 | Input pin |
| 6 | I6 | Input pin |
| 7 | I7 | Input pin |
| 8 | I8 | Input pin |
| 9 | VCC | Power supply pin |
| 10 | GND | GND pin |
| 11 | O8 | Output pin |
| 12 | O7 | Output pin |
| 13 | O6 | Output pin |
| 14 | O5 | Output pin |
| 15 | O4 | Output pin |
| 16 | O3 | Output pin |
| 17 | O2 | Output pin |
| 18 | O1 | Output pin |

Equivalent circuit (each driver)

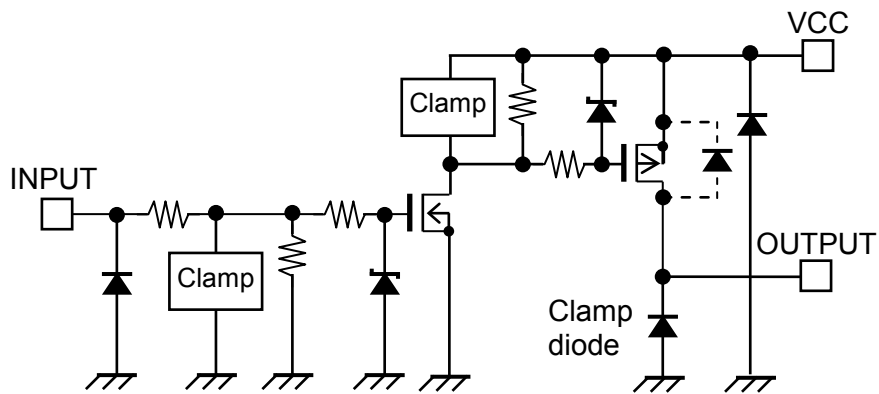

Equivalent circuit may be simplified for explanatory purpose.

Absolute Maximum Ratings (Ta = 25°C)

| Characteristics | Symbol | Rating | Unit |
|--------------------------------------|------------------|------------|------|
| Power supply voltage | V _{CC} | -0.5 to 50 | V |
| Output current (for each channel) | I _{OUT} | -500 | mA |
| Input voltage | V _{IN} | -0.5 to 30 | V |
| Clamp diode reverse voltage | V _R | 50 | V |
| Clamp diode forward current | I _F | 500 | mA |
| Power dissipation | PG (Note1) | 1.47 | W |
| | FG (Note2) | 0.96 | |
| | FNG (Note3) | 0.96 | |
| | FWG (Note4) | 1.31 | |
| Operating temperature | T _{opr} | -40 to 85 | °C |
| Storage temperature | T _{stg} | -55 to 150 | °C |

Note1: Device alone. When Ta exceeds 25°C, it is necessary to do the derating with 11.8 mW/°C.

Note2: Device alone. When Ta exceeds 25°C, it is necessary to do the derating with 7.7 mW/°C.

Note3: On PCB (Size: 50 mm × 50 mm × 1.6 mm, Cu area: 40%, single-side glass epoxy).

When Ta exceeds 25°C, it is necessary to do the derating with 7.7 mW/°C.

Note4: On PCB (Size: 75 mm × 114 mm × 1.6 mm, Cu area: 20%, single-side glass epoxy).

When Ta exceeds 25°C, it is necessary to do the derating with 10.48 mW/°C.

Operating Ranges (Ta = -40 to 85°C)

| Characteristics | Symbol | Condition | Min | Typ. | Max | Unit | | |
|--------------------------------------|-----------------------|----------------------------|---|---|------------|------|------|------|
| Power supply voltage | V _{CC} | I _{OUT} = -100 mA | 2.0 | — | 50 | V | | |
| Output current (for each channel) | PG (Note1) | 1 circuits ON, Ta = 25°C | 0 | — | -400 | mA | | |
| | | | t _{pw} = 25 ms 8 circuits ON Ta = 85°C T _j = 120°C | Duty = 10% | 0 | | — | -390 |
| | | Duty = 50% | | 0 | — | | -170 | |
| | | FG (Note1) | 1 circuits ON, Ta = 25°C | 0 | — | | -400 | |
| | | | | t _{pw} = 25 ms 8 circuits ON Ta = 85°C T _j = 120°C | Duty = 10% | | 0 | — |
| | | | Duty = 50% | | 0 | | — | -140 |
| | FNG (Note2) | | 1 circuits ON, Ta = 25°C | 0 | — | | -400 | |
| | | | | t _{pw} = 25 ms 8 circuits ON Ta = 85°C T _j = 120°C | Duty = 10% | | 0 | — |
| | | | Duty = 50% | | 0 | | — | -140 |
| | | FWG (Note3) | 1 circuits ON, Ta = 25°C | 0 | — | | -400 | |
| | | | | t _{pw} = 25 ms 8 circuits ON Ta = 85°C T _j = 120°C | Duty = 10% | | 0 | — |
| | | | Duty = 50% | | 0 | | — | -160 |
| Input voltage (Output on) | V _{IN (ON)} | | I _{OUT} = -100 mA or upper, V _{DS} = 2.0 V | 2.0 | — | 25 | V | |
| Input voltage (Output off) | V _{IN (OFF)} | | I _{OUT} = -100 μA or less, V _{DS} = 2.0 V | 0 | — | 0.6 | V | |
| Clamp diode forward current | I _F | | — | — | — | 400 | mA | |

Note1: Device alone.

Note2: On PCB (Size: 50 mm × 50 mm × 1.6 mm, Cu area: 40%, single-side glass epoxy).

Note3: On PCB (Size: 75 mm × 114 mm × 1.6 mm, Cu area: 20%, single-side glass epoxy).

Electrical Characteristics (Ta = 25°C unless otherwise noted)

| Characteristics | Symbol | Test Circuit | Condition | Min | Typ. | Max | Unit |
|--|---------------------------------------|--------------|--|-----|---------------|-----------------|----------|
| Output leakage current | I _{leak} | 1 | V _{CC} = 50 V, V _{IN} = 0 V Ta = 85°C | — | — | 1.0 | μA |
| Output voltage (Output ON-resistance) | V _{DS} (R _{ON}) | 2 | I _{OUT} = -350 mA V _{IN} = 5.0 V, V _{CC} = 5.0 V | — | 0.56 (1.6) | 1.14 (3.25) | V (Ω) |
| | | | I _{OUT} = -200 mA V _{IN} = 5.0 V, V _{CC} = 5.0 V | — | 0.32 (1.6) | 0.65 (3.25) | |
| | | | I _{OUT} = -100 mA V _{IN} = 5.0 V, V _{CC} = 5.0 V | — | 0.16 (1.6) | 0.325 (3.25) | |
| Input current (Output on) | I _{IN} (ON) | 3 | V _{IN} = 2.0 V | — | — | 0.1 | mA |
| Input current (Output off) | I _{IN} (OFF) | 4 | V _{IN} = 0 V, Ta = 85°C | — | — | 1.0 | μA |
| Input voltage (Output on) | V _{IN} (ON) | 5 | I _{OUT} = -100 mA or upper V _{DS} = 2.0 V | — | — | 2.0 | V |
| Supply current (for each channel) | I _{CC} | 3 | V _{IN} = 2.0 V, V _{CC} = 50 V Output open | — | — | 1.5 | mA |
| Clamp diode reverse current | I _R | 6 | V _R = 50 V, Ta = 85°C | — | — | 1.0 | μA |
| Clamp diode forward voltage | V _F | 7 | I _F = 350 mA | — | — | 2.0 | V |
| Turn-on delay | t _{ON} | 8 | V _{CC} = 50 V R _L = 125 Ω C _L = 15 pF | — | 0.4 | — | μs |
| Turn-off delay | t _{OFF} | | | — | 2.0 | — | |

Test circuit

1. I_{leak}

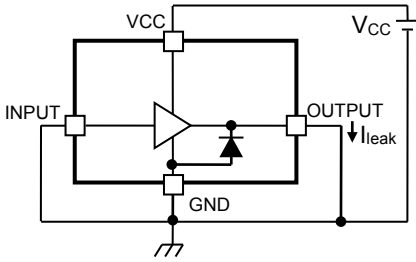

2. $V_{DS} (R_{ON})$

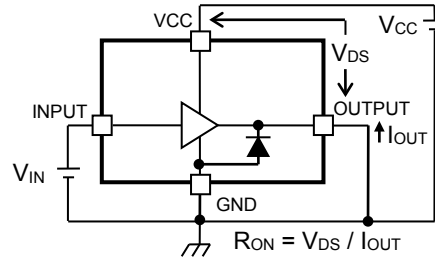

3. $I_{IN} (ON), I_{CC}$

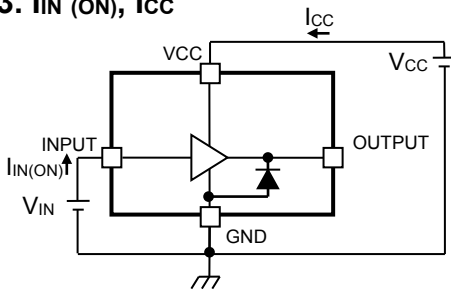

4. $I_{IN} (OFF)$

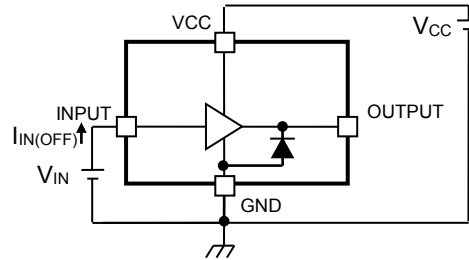

5. $V_{IN} (ON)$

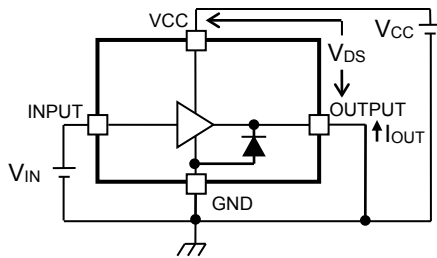

6. I_R

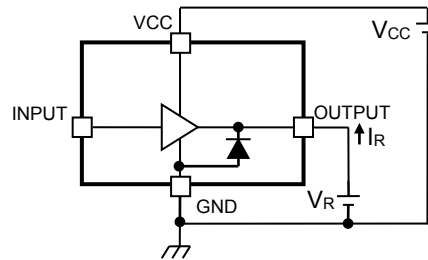

7. V_F

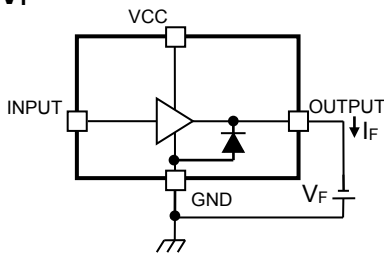

Test circuit may be simplified for explanatory purpose.

8. t_{ON}, t_{OFF}

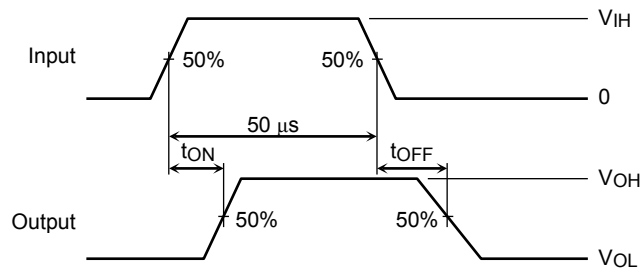
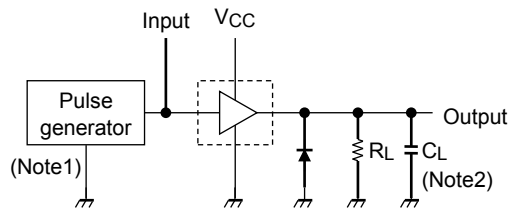

Note 1: Pulse width 50 μs, Duty cycle 10%

Output impedance 50 Ω, tr ≤ 5 ns, tf ≤ 10 ns, VIH = 5.0 V

Note 2: CL includes the probe and the test board capacitance.

Test circuit and timing chart may be simplified for explanatory purpose.

Precautions for Using

This IC does not include built-in protection circuits for excess current or overvoltage. Therefore, if the short-circuit between adjacent pins or between outputs, the short-to-power or ground fault has occurred, the current or voltage beyond the absolute maximum rating is impressed, and IC destroys. When designing, please consider enough in power supply line, output line and GND line. In addition, so as not to continue to flow a current that exceeds the absolute maximum rating of the IC, please insert the appropriate fuse in the power supply line.

Package Dimensions

P-DIP18-300-2.54-001

Unit: mm

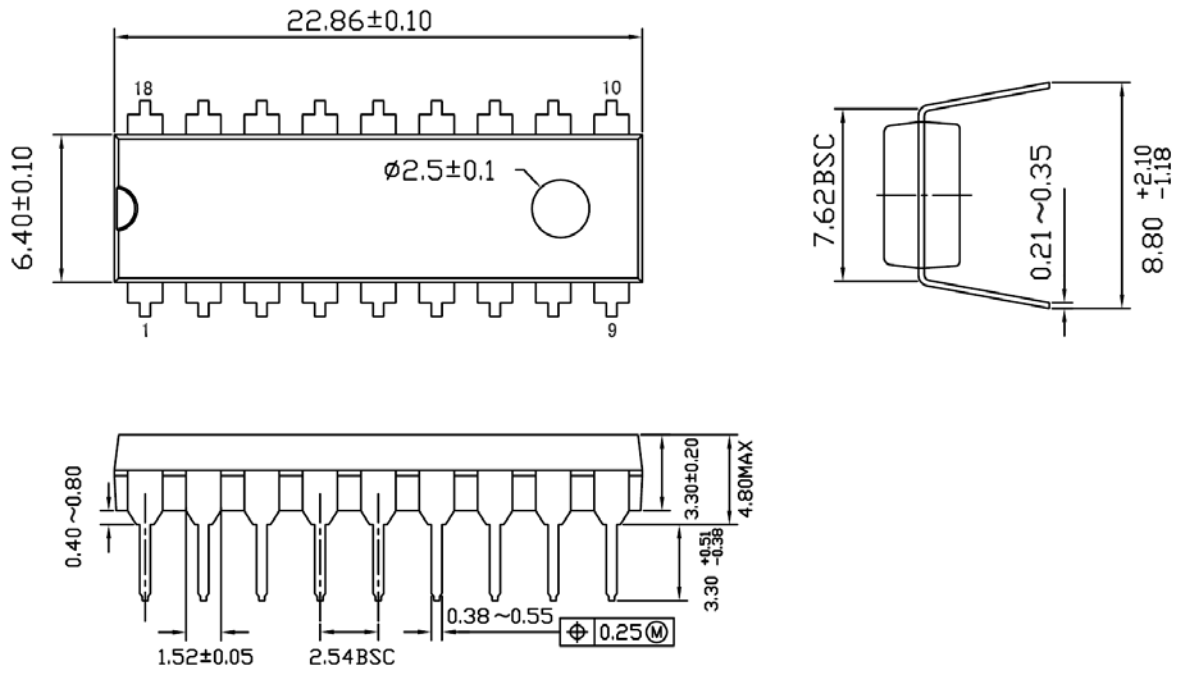

Weight: 1.3 g (Typ.)

SOP18-P-375-1.27

Unit: mm

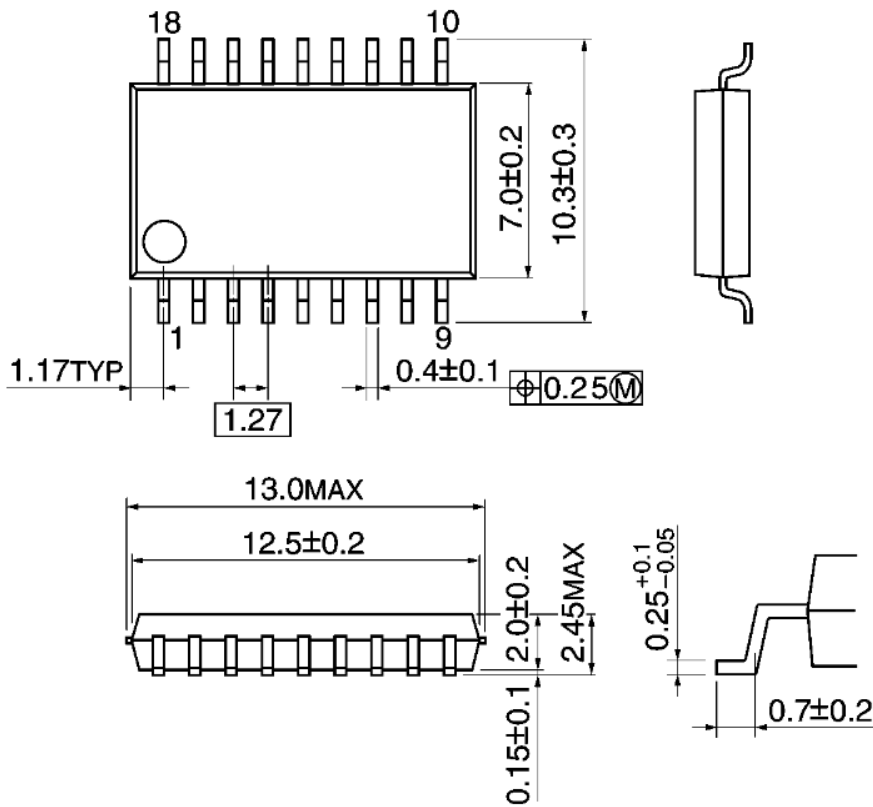

Weight: 0.41 g (Typ.)

Package Dimensions

SSOP18-P-225-0.65

Unit: mm

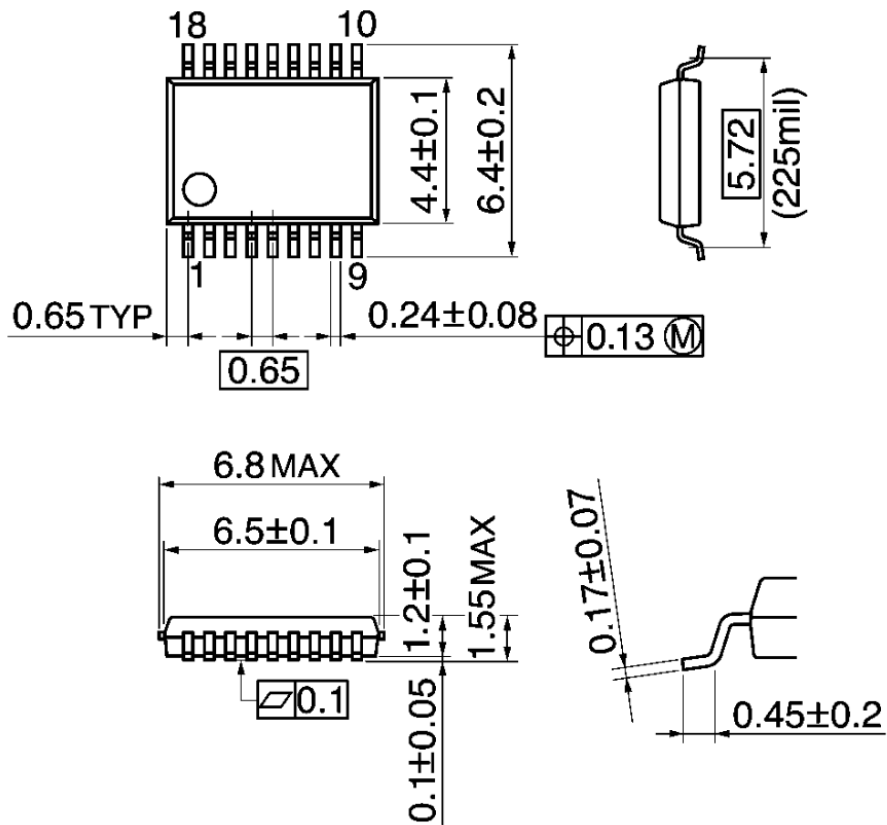

Weight: 0.09 g (Typ.)

P-SOP18-0812-1.27-001

Unit: mm

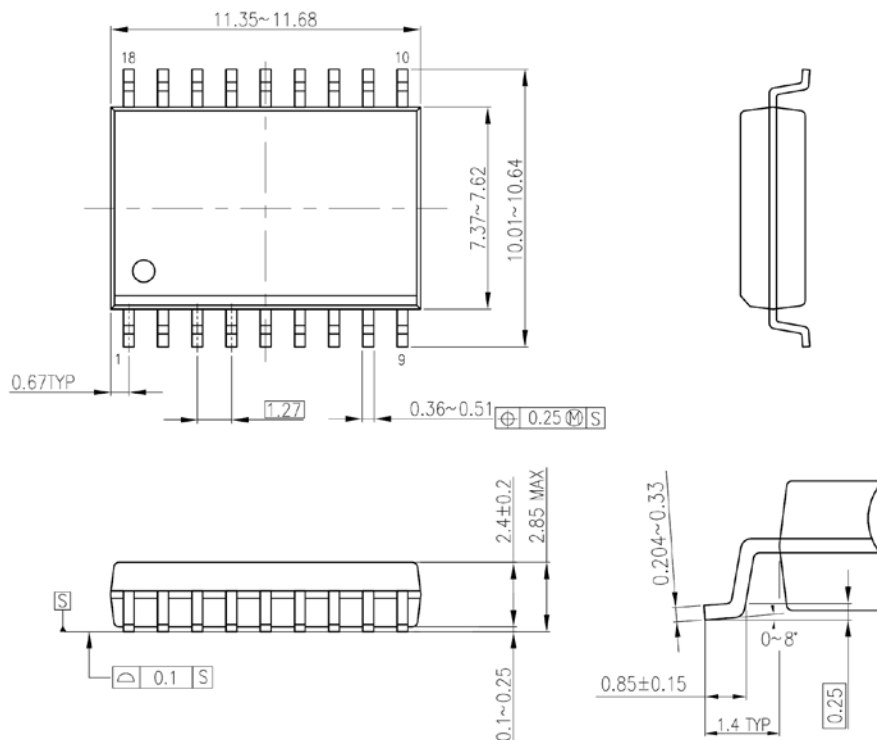

Weight: 0.48 g (Typ.)

Notes on Contents

1. Pin connection

Pin connection may be simplified for explanatory purpose.

2. Equivalent Circuits

Equivalent circuit may be simplified for explanatory purpose.

3. Timing chart

Timing charts may be simplified for explanatory purposes.

4. Test circuit

Test circuit may be simplified for explanatory purpose.

IC Usage Considerations

Notes on handling of ICs

- (1) The absolute maximum ratings of a semiconductor device are a set of ratings that must not be exceeded, even for a moment. Do not exceed any of these ratings. Exceeding the rating(s) may cause device breakdown, damage or deterioration, and may result in injury by explosion or combustion.
- (2) Do not insert devices in the wrong orientation or incorrectly. Make sure that the positive and negative terminals of power supplies are connected properly. Otherwise, the current or power consumption may exceed the absolute maximum rating, and exceeding the rating(s) may cause device breakdown, damage or deterioration, and may result in injury by explosion or combustion. In addition, do not use any device inserted in the wrong orientation or incorrectly to which current is applied even just once.
- (3) Use an appropriate power supply fuse to ensure that a large current does not continuously flow in the case of overcurrent and/or IC failure. The IC will fully break down when used under conditions that exceed its absolute maximum ratings, when the wiring is routed improperly or when an abnormal pulse noise occurs from the wiring or load, causing a large current to continuously flow and the breakdown can lead to smoke or ignition. To minimize the effects of the flow of a large current in the case of breakdown, appropriate settings, such as fuse capacity, fusing time and insertion circuit location, are required.
- (4) If your design includes an inductive load such as a motor coil, incorporate a protection circuit into the design to prevent device malfunction or breakdown caused by the current resulting from the inrush current at power ON or the negative current resulting from the back electromotive force at power OFF. IC breakdown may cause injury, smoke or ignition. Use a stable power supply with ICs with built-in protection functions. If the power supply is unstable, the protection function may not operate, causing IC breakdown. IC breakdown may cause injury, smoke or ignition.
- (5) Carefully select external components (such as inputs and negative feedback capacitors) and load components (such as speakers), for example, power amp and regulator. If there is a large amount of leakage current such as from input or negative feedback condenser, the IC output DC voltage will increase. If this output voltage is connected to a speaker with low input withstand voltage, overcurrent or IC failure may cause smoke or ignition. (The overcurrent may cause smoke or ignition from the IC itself.) In particular, please pay attention when using a Bridge Tied Load (BTL) connection-type IC that inputs output DC voltage to a speaker directly.

Points to remember on handling of ICs

Heat Radiation Design

When using an IC with large current flow such as power amp, regulator or driver, design the device so that heat is appropriately radiated, in order not to exceed the specified junction temperature (T_J) at any time or under any condition. These ICs generate heat even during normal use. An inadequate IC heat radiation design can lead to decrease in IC life, deterioration of IC characteristics or IC breakdown. In addition, when designing the device, take into consideration the effect of IC heat radiation with peripheral components.

Back-EMF

When a motor rotates in the reverse direction, stops or slows abruptly, current flows back to the motor's power supply owing to the effect of back-EMF. If the current sink capability of the power supply is small, the device's motor power supply and output pins might be exposed to conditions beyond the absolute maximum ratings. To avoid this problem, take the effect of back-EMF into consideration in system design.

RESTRICTIONS ON PRODUCT USE

- Toshiba Corporation, and its subsidiaries and affiliates (collectively "TOSHIBA"), reserve the right to make changes to the information in this document, and related hardware, software and systems (collectively "Product") without notice.
- This document and any information herein may not be reproduced without prior written permission from TOSHIBA. Even with TOSHIBA's written permission, reproduction is permissible only if reproduction is without alteration/omission.
- Though TOSHIBA works continually to improve Product's quality and reliability, Product can malfunction or fail. Customers are responsible for complying with safety standards and for providing adequate designs and safeguards for their hardware, software and systems which minimize risk and avoid situations in which a malfunction or failure of Product could cause loss of human life, bodily injury or damage to property, including data loss or corruption. Before customers use the Product, create designs including the Product, or incorporate the Product into their own applications, customers must also refer to and comply with (a) the latest versions of all relevant TOSHIBA information, including without limitation, this document, the specifications, the data sheets and application notes for Product and the precautions and conditions set forth in the "TOSHIBA Semiconductor Reliability Handbook" and (b) the instructions for the application with which the Product will be used with or for. Customers are solely responsible for all aspects of their own product design or applications, including but not limited to (a) determining the appropriateness of the use of this Product in such design or applications; (b) evaluating and determining the applicability of any information contained in this document, or in charts, diagrams, programs, algorithms, sample application circuits, or any other referenced documents; and (c) validating all operating parameters for such designs and applications. **TOSHIBA ASSUMES NO LIABILITY FOR CUSTOMERS' PRODUCT DESIGN OR APPLICATIONS.**
- **PRODUCT IS NEITHER INTENDED NOR WARRANTED FOR USE IN EQUIPMENTS OR SYSTEMS THAT REQUIRE EXTRAORDINARILY HIGH LEVELS OF QUALITY AND/OR RELIABILITY, AND/OR A MALFUNCTION OR FAILURE OF WHICH MAY CAUSE LOSS OF HUMAN LIFE, BODILY INJURY, SERIOUS PROPERTY DAMAGE AND/OR SERIOUS PUBLIC IMPACT ("UNINTENDED USE").** Except for specific applications as expressly stated in this document, Unintended Use includes, without limitation, equipment used in nuclear facilities, equipment used in the aerospace industry, medical equipment, equipment used for automobiles, trains, ships and other transportation, traffic signaling equipment, equipment used to control combustions or explosions, safety devices, elevators and escalators, devices related to electric power, and equipment used in finance-related fields. **IF YOU USE PRODUCT FOR UNINTENDED USE, TOSHIBA ASSUMES NO LIABILITY FOR PRODUCT.** For details, please contact your TOSHIBA sales representative.
- Do not disassemble, analyze, reverse-engineer, alter, modify, translate or copy Product, whether in whole or in part.
- Product shall not be used for or incorporated into any products or systems whose manufacture, use, or sale is prohibited under any applicable laws or regulations.
- The information contained herein is presented only as guidance for Product use. No responsibility is assumed by TOSHIBA for any infringement of patents or any other intellectual property rights of third parties that may result from the use of Product. No license to any intellectual property right is granted by this document, whether express or implied, by estoppel or otherwise.
- **ABSENT A WRITTEN SIGNED AGREEMENT, EXCEPT AS PROVIDED IN THE RELEVANT TERMS AND CONDITIONS OF SALE FOR PRODUCT, AND TO THE MAXIMUM EXTENT ALLOWABLE BY LAW, TOSHIBA (1) ASSUMES NO LIABILITY WHATSOEVER, INCLUDING WITHOUT LIMITATION, INDIRECT, CONSEQUENTIAL, SPECIAL, OR INCIDENTAL DAMAGES OR LOSS, INCLUDING WITHOUT LIMITATION, LOSS OF PROFITS, LOSS OF OPPORTUNITIES, BUSINESS INTERRUPTION AND LOSS OF DATA, AND (2) DISCLAIMS ANY AND ALL EXPRESS OR IMPLIED WARRANTIES AND CONDITIONS RELATED TO SALE, USE OF PRODUCT, OR INFORMATION, INCLUDING WARRANTIES OR CONDITIONS OF MERCHANTABILITY, FITNESS FOR A PARTICULAR PURPOSE, ACCURACY OF INFORMATION, OR NONINFRINGEMENT.**
- Do not use or otherwise make available Product or related software or technology for any military purposes, including without limitation, for the design, development, use, stockpiling or manufacturing of nuclear, chemical, or biological weapons or missile technology products (mass destruction weapons). Product and related software and technology may be controlled under the applicable export laws and regulations including, without limitation, the Japanese Foreign Exchange and Foreign Trade Law and the U.S. Export Administration Regulations. Export and re-export of Product or related software or technology are strictly prohibited except in compliance with all applicable export laws and regulations.
- Please contact your TOSHIBA sales representative for details as to environmental matters such as the RoHS compatibility of Product. Please use Product in compliance with all applicable laws and regulations that regulate the inclusion or use of controlled substances, including without limitation, the EU RoHS Directive. **TOSHIBA ASSUMES NO LIABILITY FOR DAMAGES OR LOSSES OCCURRING AS A RESULT OF NONCOMPLIANCE WITH APPLICABLE LAWS AND REGULATIONS.**