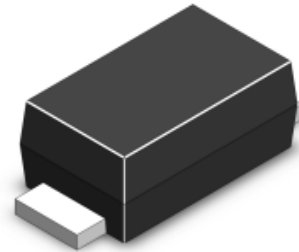


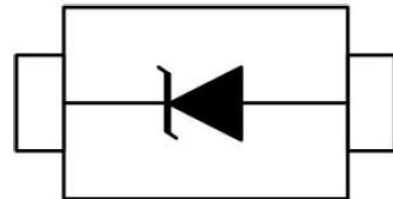
### Features

- Ultra low leakage: nA level
- Operating voltage: 12V
- Low clamping voltage
- Complies with following standards:
  - IEC 61000-4-2 (ESD) immunity test
    - Air discharge:  $\pm 15\text{kV}$
    - Contact discharge:  $\pm 8\text{kV}$
  - IEC61000-4-5 (Lightning) 5.9A (8/20 $\mu\text{s}$ )
- RoHS Compliant

### Dimensions SOD-923



### Pin Configuration



### Applications

- USB 2.0 power and data line
- Set-top box and digital TV
- Digital video interface (DVI)
- Notebook Computers
- SIM Ports
- 10/100 Ethernet

### Mechanical Characteristics

- Package: SOD-923
- Lead Finish: Lead Free
- UL Flammability Classification Rating 94V-0
- Quantity Per Reel: 8,000pcs
- Reel Size: 7 inch

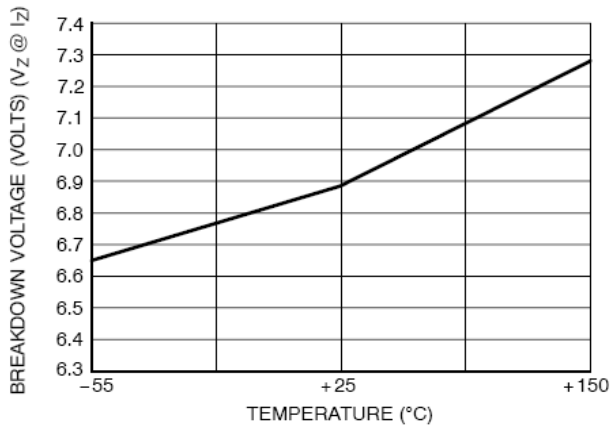
### Absolute Maximum Ratings (T<sub>amb</sub>=25°C unless otherwise specified)

Parameter	Symbol	Value	Unit
Peak Pulse Power (8/20 $\mu\text{s}$ )	P <sub>pp</sub>	140	W
ESD per IEC 61000-4-2 (Air)	V <sub>ESD</sub>	$\pm 15$	Kv
ESD per IEC 61000-4-2 (Contact)		$\pm 8$	
Operating Temperature Range	T <sub>J</sub>	-55 to +125	°C
Storage Temperature Range	T <sub>STJ</sub>	-55 to +150	°C

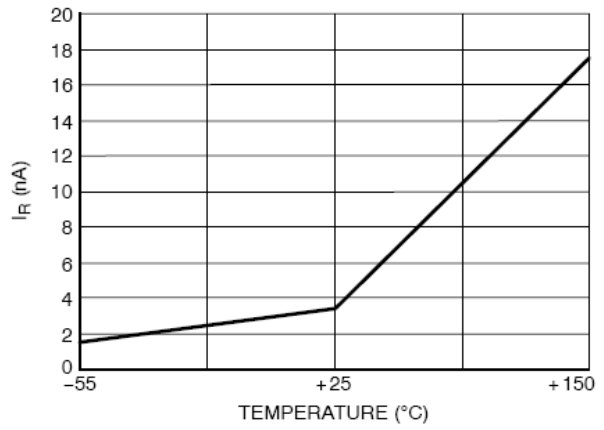
## Electrical Characteristics (TA=25°C unless otherwise specified)

Part Number	Device Marking	V <sub>RWM</sub> (V)	V <sub>BR</sub> (V)	I <sub>T</sub> (mA)	V <sub>C</sub> @1A	V <sub>C</sub>		I <sub>R</sub> μA (Max)	C (Pf) (Typ.)
						(Max)	(@A)		
ESD9D12V	-	12	13.5	1	-	23.7	5.9	1	30

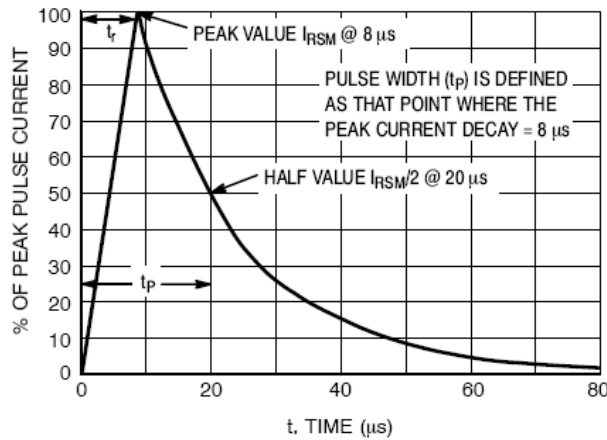
## TYPICAL CHARACTERISTICS



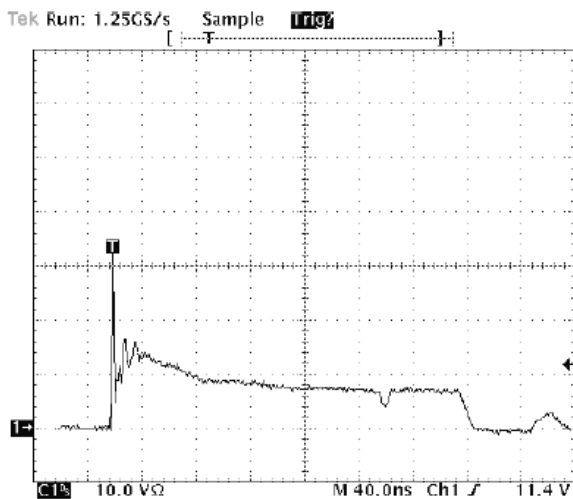
**Figure 1. Typical Breakdown Voltage versus Temperature**



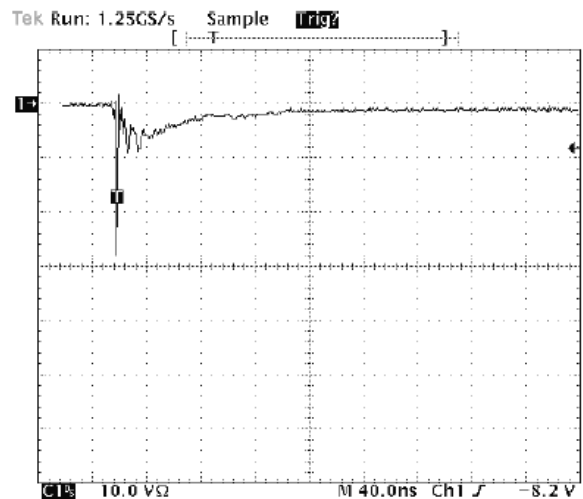
**Fig 2. Typical Leakage Current versus Temperature**



**Figure 3. 8\*20  $\mu s$  Pulse Waveform**

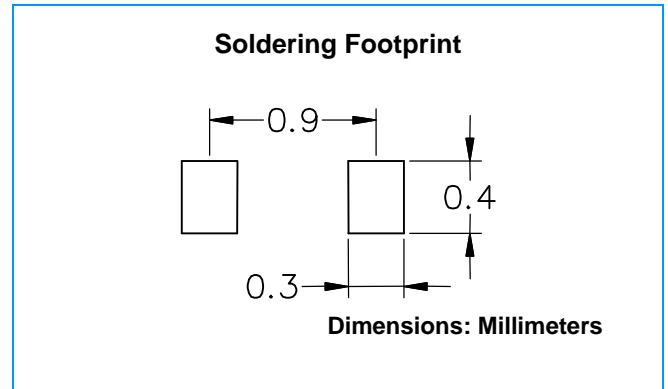
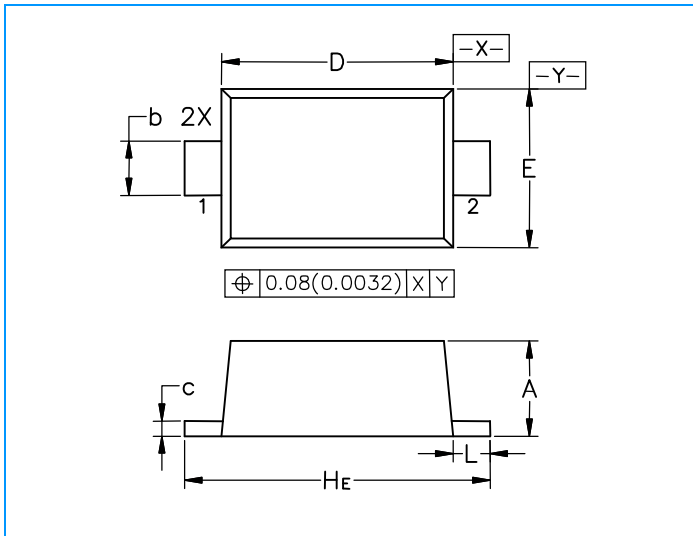


**Figure 4. Positive 8kV contact per IEC 61000-4-2-LESD9D5.0T5G**



**Fig 5. Negative 8kV contact per IEC 61000-4-2-LESD9D5.0T5G**

## SOD-923 Mechanical Data



Dim	Millimeters			Inches		
	Min	Nom	Max	Min	Nom	Max
A	0.36	0.40	0.43	0.014	0.016	0.017
b	0.15	0.20	0.25	0.006	0.008	0.010
c	0.07	0.12	0.17	0.003	0.005	0.007
D	0.75	0.80	0.85	0.030	0.031	0.033
E	0.55	0.60	0.65	0.022	0.024	0.026
HE	0.95	1.00	1.05	0.037	0.039	0.041
L	0.05	0.10	0.15	0.002	0.004	0.006