

# Contents

	Page
Introduction .....	
1.0 Scope.....	4
2.0 Ratings & Dimension .....	4
<hr/>	
3.0 Power Rating.....	5
<hr/>	
4.0 Structure.....	5
5.0 Marking.....	5~6
6.0 Performance Specification .....	6~7
7.0 Explanation of Part No. System.....	7
8.0 Ordering Procedure .....	8
9.0 Packing.....	8~9
10.0 Precaution for storage/Transportation.....	10

File Name CS Series :t1% & :t5%		Date	2017 07.27	Edilion No	
AmendmenlRecord				Signalure	
Edilion	Prescription 01amendment	Amend Page	Amend Dale	Amended by	Checked by

## 1.0 Scope:

This sheet is the statement of the Current Sensing Chip Resistor specification that ROYALOHM's productions can meet.

## 2.0 Ratings & Dimension:

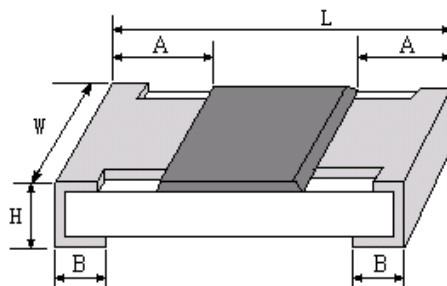

**Dimension (mm)**

Type		CS02	CS03	CS05	CS06	CS07	CS10	CS11	CS12
Power Rating at 70°C		1/8W	1/5W	1/4W	1/3W	1/2W	3/4W	3/4W	1W
Dimension(mm)	L	1.00±0.10	1.60±0.10	2.00±0.15	3.10±0.15	3.10±0.10	5.00±0.10	4.50±0.20	6.35±0.10
	W	0.50±0.05	0.80±0.10	1.25 +0.15 -0.10	1.55 +0.15 -0.10	2.60±0.20	2.50±0.20	3.20±0.20	3.20±0.20
	H	0.35±0.05	0.45±0.10	0.55±0.10	0.55±0.10	0.55±0.10	0.55±0.10	0.55±0.20	0.55±0.10
	A	0.20±0.10	0.30±0.20	0.40±0.20	0.45±0.20	0.50±0.25	0.60±0.25	0.50±0.20	0.60±0.25
	B	0.25±0.10	0.30±0.20	0.40±0.20	0.45±0.20	0.50±0.20	0.50±0.20	0.80±0.30	0.80±0.30
Resistance range	±1%	50mΩ~1Ω	10mΩ~1Ω	10mΩ~1Ω	10mΩ~1Ω	10mΩ~1Ω	10mΩ~1Ω	10mΩ~1Ω	10mΩ~1Ω
	±5%	50mΩ~1Ω	10mΩ~1Ω	10mΩ~1Ω	10mΩ~1Ω	10mΩ~1Ω	10mΩ~1Ω	10mΩ~1Ω	10mΩ~1Ω
Dielectric Withstanding Voltage		100V	300V	500V	500V	500V	500V	500V	500V
Operating Temperature		-55 ~ +155°C							

2.1 Recommend the size of welding plate by ROYALOHM.

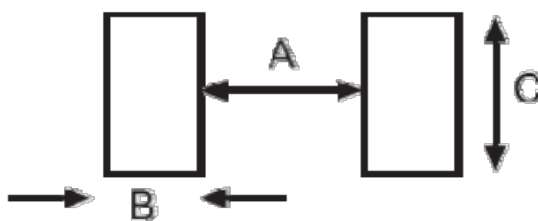

Type	A±0.1(mm)	B±0.1(mm)	C±0.1(mm)
CS02	0.50	0.50	0.60
CS03	0.80	1.00	0.90
CS05	1.00	1.00	1.40
CS06	2.00	1.20	2.00
CS07	2.00	1.20	2.70
CS10	3.60	1.40	3.00
CS11	3.50	1.20	3.20
CS12	3.80	2.10	3.60

### 3.0 Power Rating:

Resistors shall have a power rating based on continuous load operation at an ambient temperature from -55°C to 70°C. For temperature in excess of 70°C, the load shall be derate as shown in figure 1.

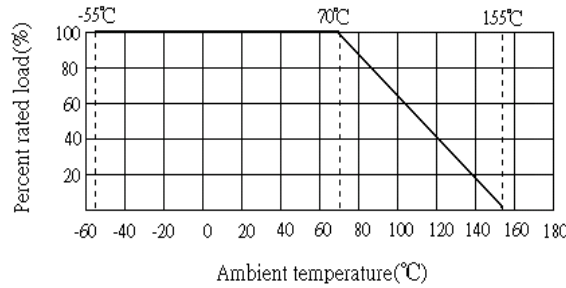

### 3.1 Voltage rating:

Resistors shall have a rated direct-current (DC) continuous working voltage or an approximate sine-wave root-mean-square (RMS) alternating-current (AC) continuous working voltage at commercial-line frequency and waveform corresponding to the power rating, as determined from the following formula:

$$RCWV = \sqrt{P * R}$$

Where: RCWV= Rated dc or RMS ac continuous working voltage at commercial-line frequency and waveform (VOLT.)

P=Power Rating (WATT.)     R=Nominal Resistance (OHM)

In no case shall the rated dc or RMS ac continuous working voltage be greater than the applicable maximum value.

The overload voltage is 2.5 times RCWV.

### 4.0 Structure:

1. High purity alumina substrate
2. Protective covering
3. Resistive covering
4. Termination (inner) Ni/Cr
5. Termination (between ) Cu
6. Termination (between) Ni
7. Termination (outer) Sn

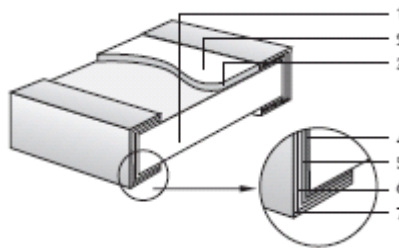

### 5.0 Marking:

(1) For CS02 size: Due to the very small size of the resistor's body, there is no marking on the body.

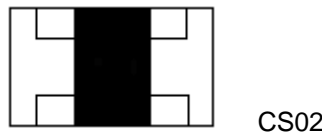

(2) For CS03 size: Below 100mΩ (do not contain) , show as following:

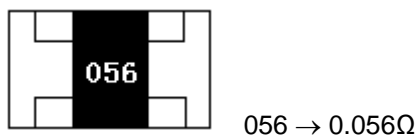

(3) For CS03 size: Above (contain) 100mΩ product: 3 digits, the first digit is "R", which as decimal point, the 2<sup>nd</sup> & 3<sup>rd</sup> digits are significant.



(4) ±1%, ±5% Tolerance: product below 1Ω show as following, the first digit is “R”, which as decimal point.

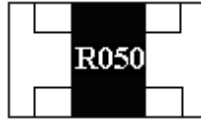

R050 → 50mΩ

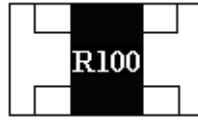

R100 → 100mΩ

(5) ±1%, ±5% Tolerance: product of 1Ω show as following, the first digit is “1”, read alphabet “R” as decimal point.

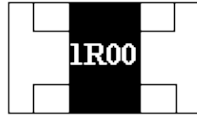

1R00 → 1Ω

**6.0 Performance Specification:**

Characteristic	Limits		Test Method (JIS-C-5201 & JIS-C-5202)
Temperature Coefficient	CS02	50mΩ ≤ R < 100mΩ: ±700ppm/°C 100mΩ ≤ R ≤ 1Ω: ±200ppm/°C	4.8 natural resistance changes per temp. Degree centigrade $R_2 - R_1 \times 10^6 \text{ (PPM/°C)}$ $\frac{R_1(T_2 - T_1)}{R_1(T_2 - T_1)}$ R <sub>1</sub> : resistance value at room temp. (T <sub>1</sub> ) R <sub>2</sub> : resistance value at room temp. +100°C (T <sub>2</sub> ) Test pattern: room temp. (T <sub>1</sub> ), room temp. +100°C(T <sub>2</sub> )
	CS03	10mΩ ≤ R < 15mΩ: ±1500ppm/°C 15mΩ ≤ R < 20mΩ: ±1000ppm/°C 20mΩ ≤ R < 30mΩ: ±800ppm/°C 30mΩ ≤ R < 33mΩ: ±600ppm/°C 33mΩ ≤ R ≤ 50mΩ: ±400ppm/°C 50mΩ < R ≤ 0.1Ω: ±300ppm/°C 0.1Ω < R ≤ 1Ω: ±200ppm/°C	
	CS05	10mΩ ≤ R ≤ 15mΩ: ±800ppm/°C 15mΩ < R ≤ 25mΩ: ±600ppm/°C 25mΩ < R ≤ 50mΩ: ±400ppm/°C 50mΩ < R ≤ 0.2Ω: ±200ppm/°C 0.2Ω < R ≤ 1Ω: ±100ppm/°C	
	CS06	10mΩ ≤ R < 15mΩ: ±700ppm/°C 15mΩ ≤ R ≤ 30mΩ: ±400ppm/°C 30mΩ < R ≤ 50mΩ: ±300ppm/°C 50mΩ < R ≤ 0.1Ω: ±200ppm/°C 0.1Ω < R ≤ 1Ω: ±150ppm/°C	
	CS07	10mΩ ≤ R < 15mΩ: ±500ppm/°C 15mΩ ≤ R < 20mΩ: ±400ppm/°C 20mΩ ≤ R ≤ 50mΩ: ±300ppm/°C 50mΩ < R ≤ 1Ω: ±100ppm/°C	
	CS10	10mΩ ≤ R < 15mΩ: ±600ppm/°C 15mΩ ≤ R < 20mΩ: ±500ppm/°C 20mΩ ≤ R ≤ 30mΩ: ±300ppm/°C 30mΩ < R ≤ 50mΩ: ±200ppm/°C 50mΩ < R ≤ 0.1Ω: ±150ppm/°C 0.1Ω < R ≤ 1Ω: ±100ppm/°C	
	CS11	10mΩ ≤ R < 20mΩ: ±500ppm/°C 20mΩ ≤ R < 50mΩ: ±400ppm/°C 50mΩ ≤ R ≤ 0.1Ω: ±200ppm/°C 0.1Ω < R ≤ 1Ω: ±100ppm/°C	
	CS12	10mΩ ≤ R < 15mΩ: ±600ppm/°C 15mΩ ≤ R < 20mΩ: ±400ppm/°C 20mΩ ≤ R ≤ 30mΩ: ±300ppm/°C 30mΩ < R ≤ 50mΩ: ±200ppm/°C 50mΩ < R ≤ 0.1Ω: ±150ppm/°C 0.1Ω < R ≤ 1Ω: ±100ppm/°C	
	Short-time overload	±1%	
±5%		± (2%+0.005Ω) Max	
Terminal bending	±(1%+0.005Ω) Max		4.33 Twist of test board: Y/x = 3/90 mm for 60Seconds

Solderability	95% coverage Min.	Wave solder: Test temperature of solder: 245°C±3°C dipping time in solder: 2-3 seconds.															
Dielectric withstanding voltage	No evidence of flashover mechanical damage, arcing or insulation breaks down.	4.7 Resistors shall be clamped in the trough of a 90°metallic v-block and shall be tested at ac potential respectively specified in the given list of each product type for 60-70 seconds.															
Temperature cycling	± (1.0%+0.005 Ω)Max	4.19Resistance change after continuous five cycles for duty cycle specified below: <table border="1"> <thead> <tr> <th>STEP</th> <th>TEMPERATURE</th> <th>TIME</th> </tr> </thead> <tbody> <tr> <td>1</td> <td>-55°C±3°C</td> <td>30 MINS</td> </tr> <tr> <td>2</td> <td>ROOM TEMP.</td> <td>10 --- 15 MINS</td> </tr> <tr> <td>3</td> <td>+155°C±2°C</td> <td>30 MINS</td> </tr> <tr> <td>4</td> <td>ROOM TEMP.</td> <td>10 --- 15 MINS</td> </tr> </tbody> </table>	STEP	TEMPERATURE	TIME	1	-55°C±3°C	30 MINS	2	ROOM TEMP.	10 --- 15 MINS	3	+155°C±2°C	30 MINS	4	ROOM TEMP.	10 --- 15 MINS
STEP	TEMPERATURE	TIME															
1	-55°C±3°C	30 MINS															
2	ROOM TEMP.	10 --- 15 MINS															
3	+155°C±2°C	30 MINS															
4	ROOM TEMP.	10 --- 15 MINS															
Soldering heat	Resistance change rate must be in ±(1%+0.005Ω)	4.18 Dip the resistor into a solder bath having a temperature of 260°C±5°C and hold it for 10±1 seconds.															
Load life in humidity	±1%      ± (1.0%+0.005Ω) Max. ±5%      ± (3.0%+0.005Ω) Max.	7.9 Resistance change after 1,000 hours (1.5 hours "ON", 0.5 hour "OFF") at RCWV in a humidity chamber controlled at 40°C±2°C and 90 to 95% relative humidity.															
Load life	±1%      ± (1.0%+0.005Ω) Max. ±5%      ± (3.0%+0.005Ω) Max.	4.25.1 Permanent resistance change after 1,000 hours operating at RCWV with duty cycle 1.5 hours "ON", 0.5 hour "OFF" at 70°C±2°C ambient.															

## 7.0 Explanation of Part No. System:

The standard Part No. includes 14 digits with the following explanation:

7.1 This is to indicate the Current Censing Chip Resistor size.

Example: CS02、CS03、CS05、CS06、CS07、CS10、CS11、CS12

7.2 5<sup>th</sup> ~ 6<sup>th</sup> digits:

7.2.1 This is to indicate the wattage or power rating. To distinguish the size and the numbers,

The following codes and the numbers are used; and please refer to the following chart for detail:

Wattage	1/2	1/3	1/4	1/5	1/6	3/4	1/8	1/10	1/16	1
Normal Size	W2	W3	W4	W5	W6	/	W8	WA	WG	1W

7.2.2 For power rating less equal to than 1 watt, the 5<sup>th</sup> digit will be the letters "W" or "S" to represent the size required & the 6<sup>th</sup> digit will be a number or a letter code.

Example: WA=1/10W

7.3 The 7<sup>th</sup> digit is to denote the Resistance Tolerance. The following letter code is to be used for indicating the standard Resistance Tolerance.

F=±1%      G=±2%      J=±5%      K= ±10%

7.4 The 8<sup>th</sup> to 11<sup>th</sup> digits is to denote the Resistance Value.

7.4.1 For the standard resistance values of 5% tolerance, the 8<sup>th</sup> digit is "0", the 9<sup>th</sup> & 10<sup>th</sup> digits are to denote the significant figures of the resistance and the 11<sup>th</sup> digit is the number of zeros following;

For the standard resistance values of 1% tolerance, the 8<sup>th</sup> digit to the 10<sup>th</sup> digits is to denote the significant figures of the resistance and the 11<sup>th</sup> digit is the zeros following.

7.4.2 The following number s and the letter codes is to be used to indicate the number of zeros in the 11<sup>th</sup> digit:

J=10<sup>-1</sup>      K=10<sup>-2</sup>      L=10<sup>-3</sup>      M=10<sup>-4</sup>

7.4.3 The 12<sup>th</sup>, 13<sup>th</sup> & 14<sup>th</sup> digits.

The 12<sup>th</sup> digit is to denote the Packaging Type with the following codes:

C=Bulk in (Chip Product)      T=Tape/Reel

7.4.4 The 13<sup>th</sup> digit is normally to indicate the Packing Quantity of Tape/Box & Tape/Reel packaging types. The following letter code is to be used for some packing quantities:

5=5,000pcs      C=10,000pcs      D=20,000pcs

7.4.5 For some items, the 14<sup>th</sup> digit alone can use to denote special features of additional information with the following codes:

E= For "Environmental Protection, Lead Free type".

8.0 Ordering Procedure: (Example: CS06 1/4W ±5% 50mΩ T/R-5000)

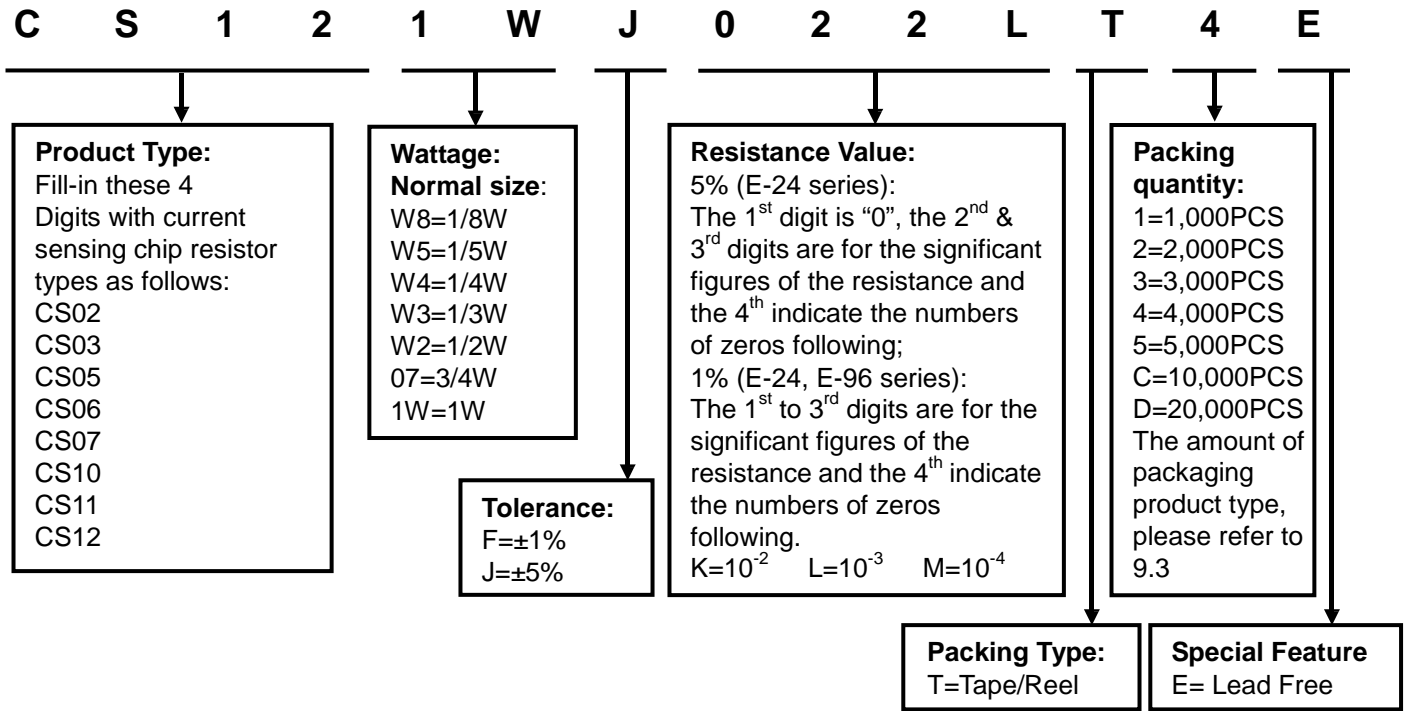

9.0 Packaging:

9.1 Tapping Dimension:

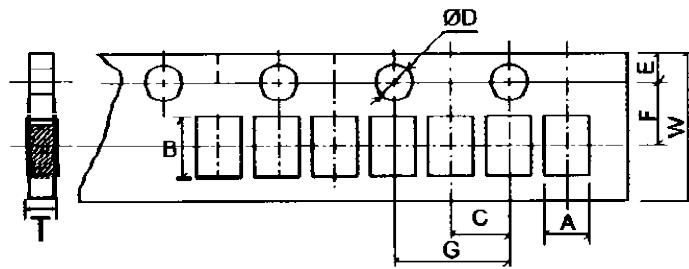

Unit: mm

Type	A	B	C±0.05	ΦD +0.1 -0	E±0.1	F±0.05	G±0.1	W±0.2	T±0.1
CS02	0.65±0.20	1.15±0.20	2.00	1.50	1.75	3.50	4.00	8.00	0.45

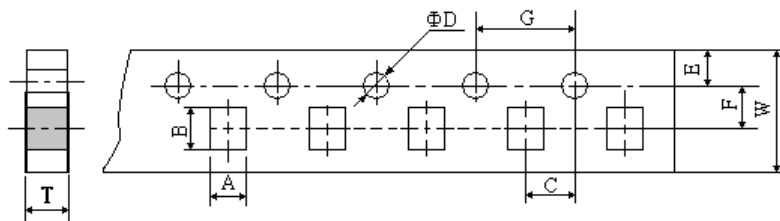

UNIT: mm

TYPE	A ± 0.2	B ± 0.2	C ± 0.05	φD + 0.1 - 0	E ± 0.1	F ± 0.05	G ± 0.1	W ± 0.2	T±0.10
CS03	1.10	1.90	2.00	1.50	1.75	3.5	4.00	8.0	0.67
CS05	1.65	2.40	2.00	1.50	1.75	3.5	4.00	8.0	0.81
CS06	2.00	3.60	2.00	1.50	1.75	3.5	4.00	8.0	0.81
CS07	2.80	3.50	2.00	1.50	1.75	3.5	4.00	8.0	0.75
CS10	2.80	5.40	2.00	1.50	1.75	5.5	4.00	12.0	0.75

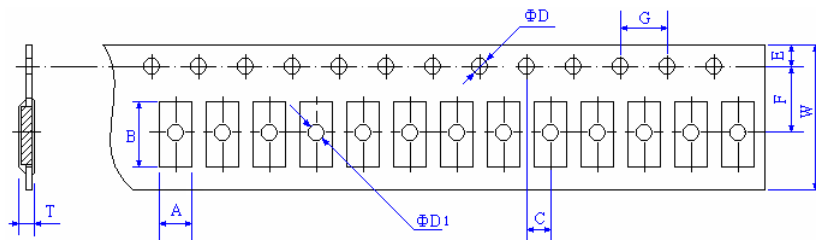

UNIT: mm

TYPE	A±0.2	B±0.2	C±0.05	$\phi D$ +0.1 - 0	$\phi D1$ +0.25 - 0	E±0.1	F±0.05	G±0.1	W±0.2	T±0.10
CS11	3.5	4.8	2.0	1.5	1.5	1.75	5.5	4.0	12.0	1.0
CS12	3.5	6.7	2.0	1.5	1.5	1.75	5.5	4.0	12.0	1.0

### 9.2 Peeling Strength of Top Cover Tape :

Test Condition: 0.1 to 0.7 N at a peel-off speed of 300 mm / min.

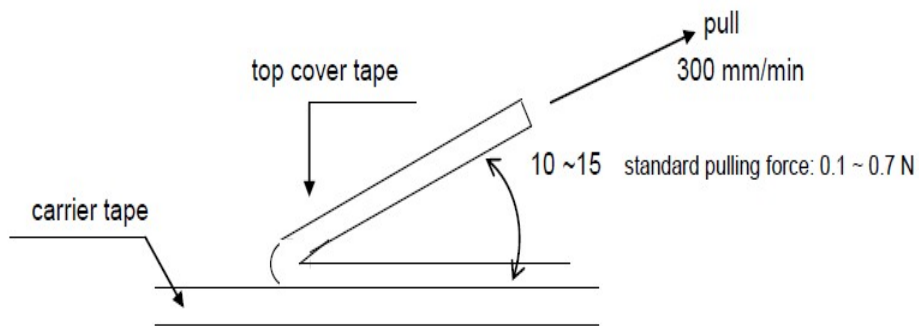

### 9.3 Dimension:

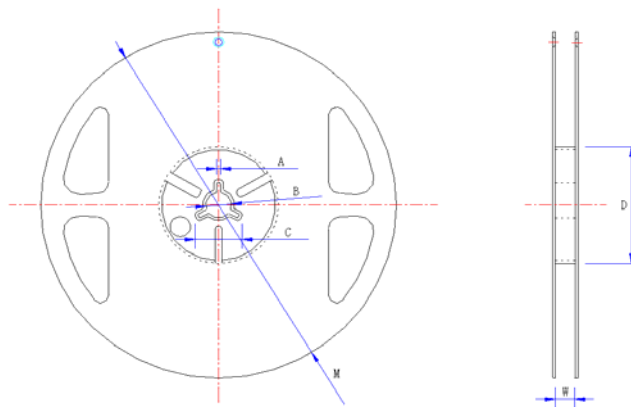

Unit: mm

TYPE	TAPING	SIZE	A±0.5	B±0.5	C±0.5	D±1	M±2	W±1
CS02	Paper	10,000pcs	2.0	13.0	21.0	60.0	178.0	10.0
CS03	Paper	5000pcs reel	2.0	13.0	21.0	60.0	178.0	10.0
CS05	Paper	5000pcs reel	2.0	13.0	21.0	60.0	178.0	10.0
CS06	Paper	5000pcs reel	2.0	13.0	21.0	60.0	178.0	10.0
CS07	Paper	5000pcs reel	2.0	13.0	21.0	60.0	178.0	10.0
CS10	Paper or Embossed	4,000pcs reel	2.0	13.0	21.0	60.0	178.0	13.8
CS11	Embossed	4,000pcs reel	2.0	13.0	21.0	60.0	178.0	13.8
CS12	Embossed	4,000pcs reel	2.0	13.0	21.0	60.0	178.0	13.8



## 10.0 Precaution for storage/Transportation:

### 10.1 Environment Related Substance.

This product complies to EU RoHS directive, EU PAHs directive, EU PFOS directive and Halogen free.

### 10.2 Ozone layer depleting substances.

Ozone depleting substances are not used in our manufacturing process of this product.

This product is not manufactured using Chloro fluorocarbons (CFCs), Hydrochlorofluorocarbons (HCFCs), Hydrobromofluorocarbons (HBFCs) or other ozone depleting substances in any phase of the manufacturing process.

### 10.3 Storage Condition

The performance of these products, including the solderability, is guaranteed for a year from the date of arrival at your company, provided that they remain packed as they were when delivered and stored at a temperature of 5°C~35°C and a relative humidity of 25%~75%RH.

Even within the above guarantee periods, do not store these products in the following conditions. Otherwise, their electrical performance and/or solderability may be deteriorated, and the packaging materials (e.g. taping materials) may be deformed or deteriorated, resulting in mounting failures.

1. In salty air or in air with a high concentration of corrosive gas, such as Cl<sub>2</sub>, H<sub>2</sub>S, NH<sub>3</sub>, SO<sub>2</sub>, or NO<sub>2</sub>.
2. In direct sunlight.