

Description

YTLP2406D is a Wi-Fi band filter, which is designed with Film Bulk Acoustic Resonator (FBAR) technology. The product can provide low insertion loss and steep skirt to enables coexistence of Wi-Fi and LTE signals within the same device or in close proximity to one another. The typical insertion loss in the pass band is less than 1.4dB. Typical rejection at the LTE Band 38 and LTE Band 7 and 41 is more than 42dB, at the LTE Band 40 is more than 41dB.

For the chip package, the YTLP2406D uses advanced module packing techniques to achieve the industry standard 1.4x1.1x0.6mm footprint, include bumping and flip chip.

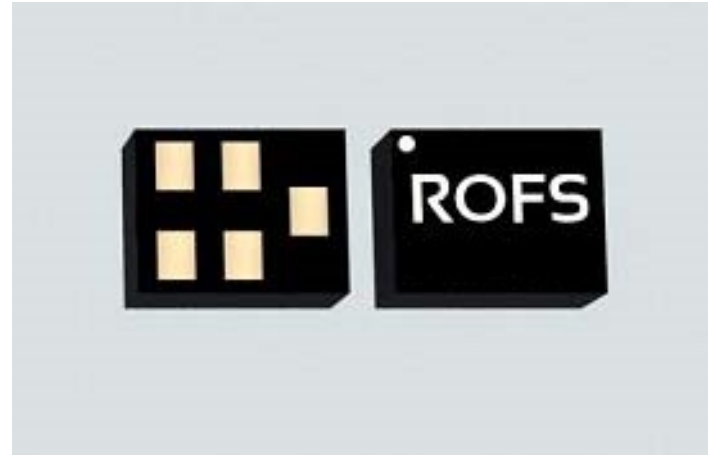

Functional Block Diagram

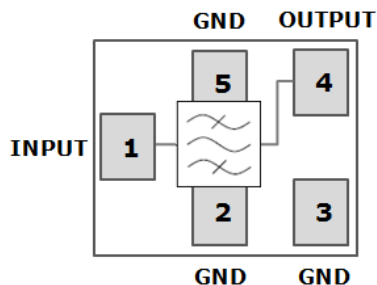

Pin Connection

No.	Function
1	Input
4	Output
2,3,5	Ground

Features

- For Wi-Fi - LTE coexistence application
- Plastic Chip Scale Package(CSP)
- Miniature Size: 1.4mm x 1.1 mm x 0.6 mm
- Fast Roll-off from Wi-Fi to near LTE Bands
- High Rejection at LTE bands.
- Low Temperature Coefficient of Frequency
- Storage temperature range: -40 to +150 °C
- Excellent ESD protection ability: Class 1C
- Moisture Sensitivity : MSL3

Applications

- Wi-Fi bandpass filter enables the coexistence of (LTE/TD-LTE) & Wi-Fi
- ISM band applications such as Smart Meters
- Portable Hotspots and Mobile Routers

Environmental

- Full implement with RoHS compliant
- Lead Free (Pb free)



Electrical Specifications

Parameter(Operable Temperature:-25 to +85°C)	Min	Typ	Max	Unit
Insertion Loss(2402.5 ~ 2421.5 MHz)	\	1.3	2.2	dB
Insertion Loss(2407.5 ~ 2476.5 MHz)	\	1.1	1.8	dB
Insertion Loss(2462.5 ~ 2481.5 MHz)	\	1.4	2.4	dB
Ripple(2402.5 ~ 2421.5 MHz)	\	0.6	1.0	dB
Ripple(2407.5 ~ 2476.5 MHz)	\	0.6	1.0	dB
Ripple(2462.5 ~ 2481.5 MHz)	\	0.8	1.2	dB
VSWR(2402.5 ~ 2481.5 MHz)	\	1.2	1.8	\
Absolute Attenuation			\	
800 ~ 2000 MHz	32	40	\	dB
2000 ~ 2170 MHz	22	37	\	dB
2300 ~ 2370 MHz	41	50	\	dB
2370 ~ 2375 MHz	46	52	\	dB
2375 ~ 2380 MHz	10	49	\	dB
2500 ~ 2505 MHz	22	58	\	dB
2505 ~ 2570 MHz	45	62	\	dB
2570 ~ 2620 MHz	40	47	\	dB
2620 ~ 2690 MHz	38	44	\	dB
4800 ~ 5805 MHz	37	42	\	dB
RF Input Power ⁽²⁾ (2402.5 ~ 2481.5 MHz)		28		dBm

(1) **Typ Data** is the integrated value of the linear S-parameter over indicated band.

(2) Input power applied for a minimum of 5,000 hrs at 55°C in the specified frequency band



Typical Performance at Tc=25 °C

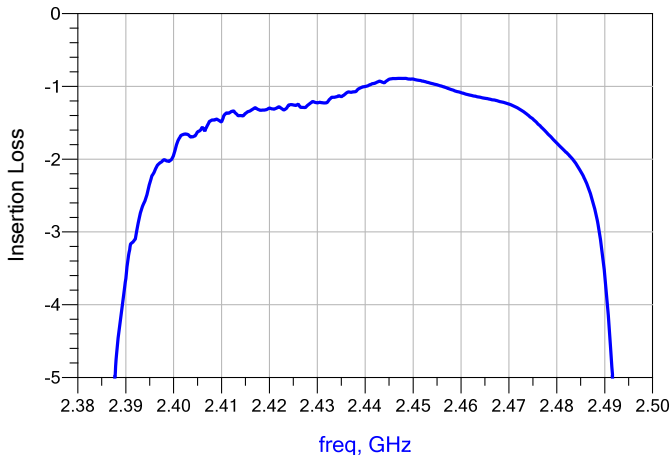

Figure.1 Passband Insertion Loss

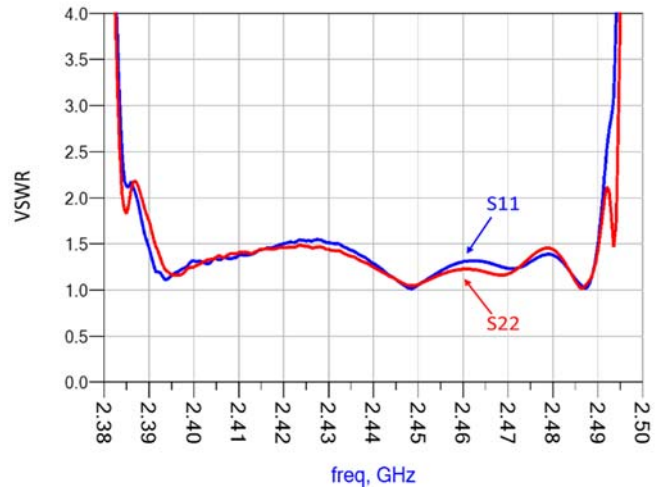

Figure.2 VSWR

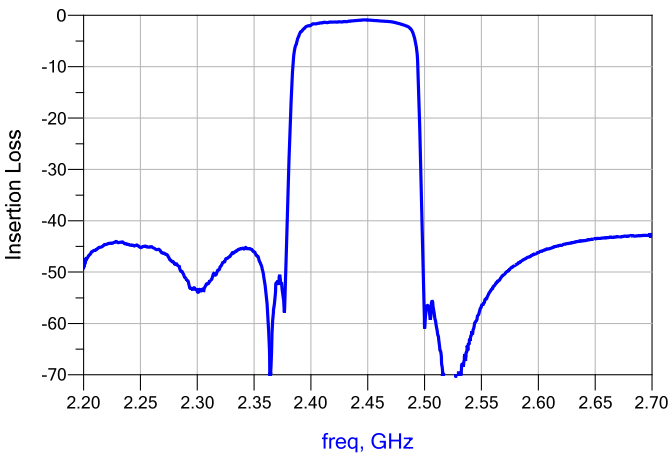

Figure.3 Narrowband Insertion Loss

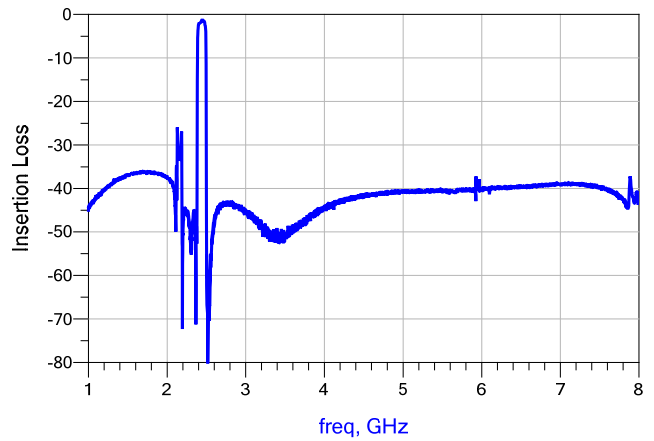

Figure.4 Wideband Insertion Loss

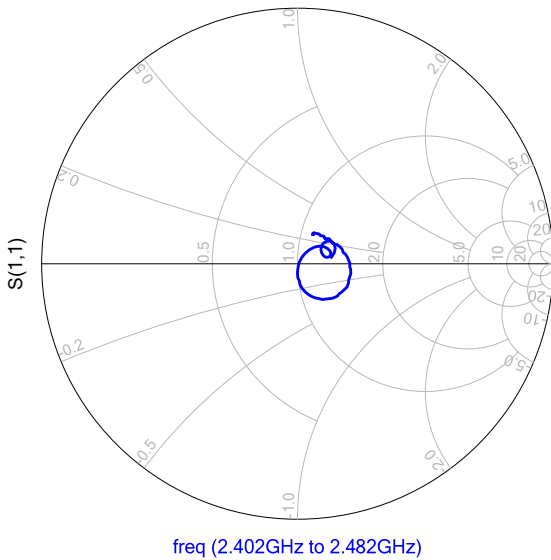

Figure.5 Input Smith Chart S11

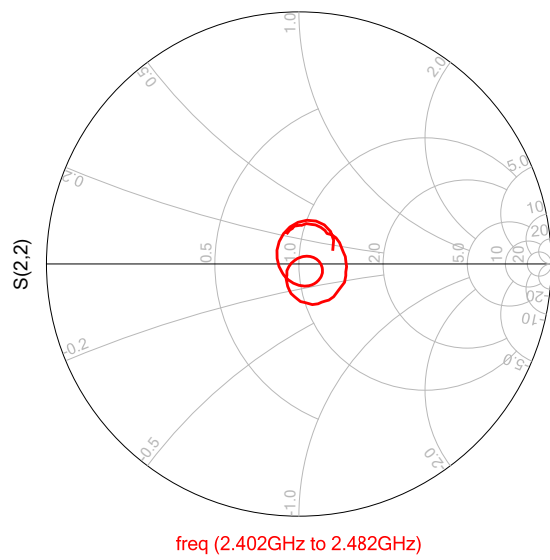
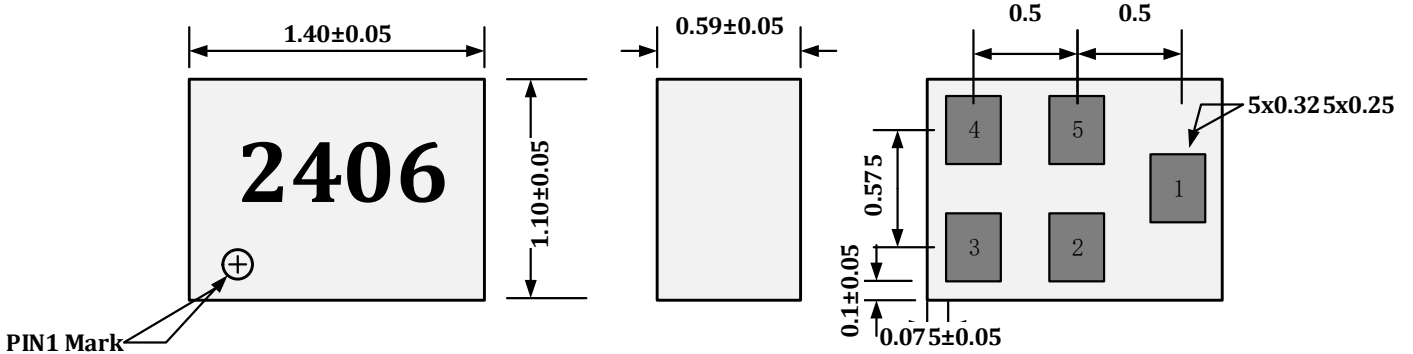

Figure.6 Output Smith Chart S22





PIN1 Mark

Notes:

1. Dimension: mm
2. Dimensions nominal unless otherwise noted
3. Contact area are gold plated
4. Pad(1) to (5) are same size
5. XX is ROFS inside code

Pin Connection:

- 1 Input
- 4 Output
- 2,3,5 Ground

Test Circuit

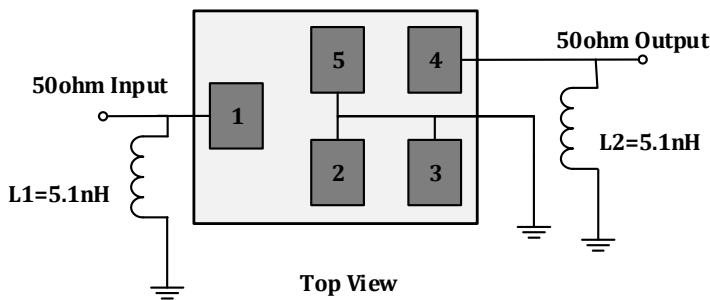

Notes:

1. Matching component values shown are ROFS evaluation board results, please adjust component values by the actual use environment.

PCB Footprint

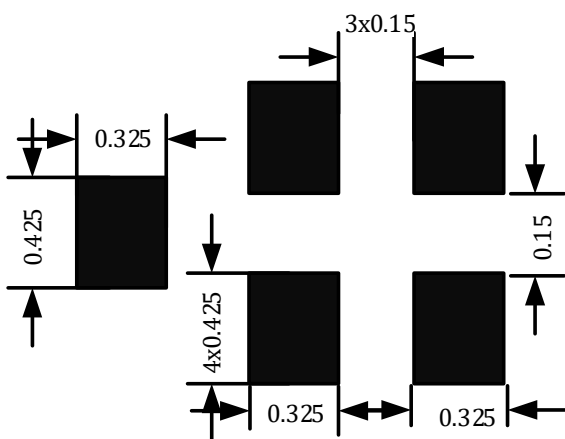

Notes:

1. Black indicates metalized area.
2. This footprint represents a recommendation only, some modification may be necessary to suit end user assembly materials and processes.
3. For solder pad recommendation see mechanical information.
4. Dimensions shown are nominal in millimeters.

Packing



1. Tape Dimension

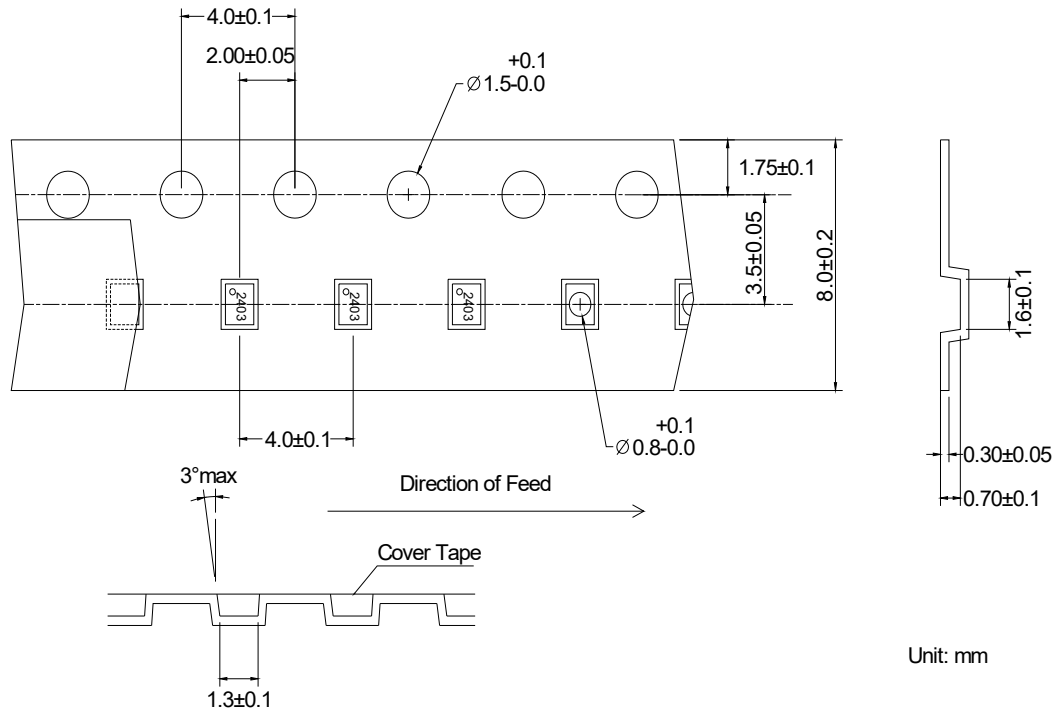

2. Reel Dimension

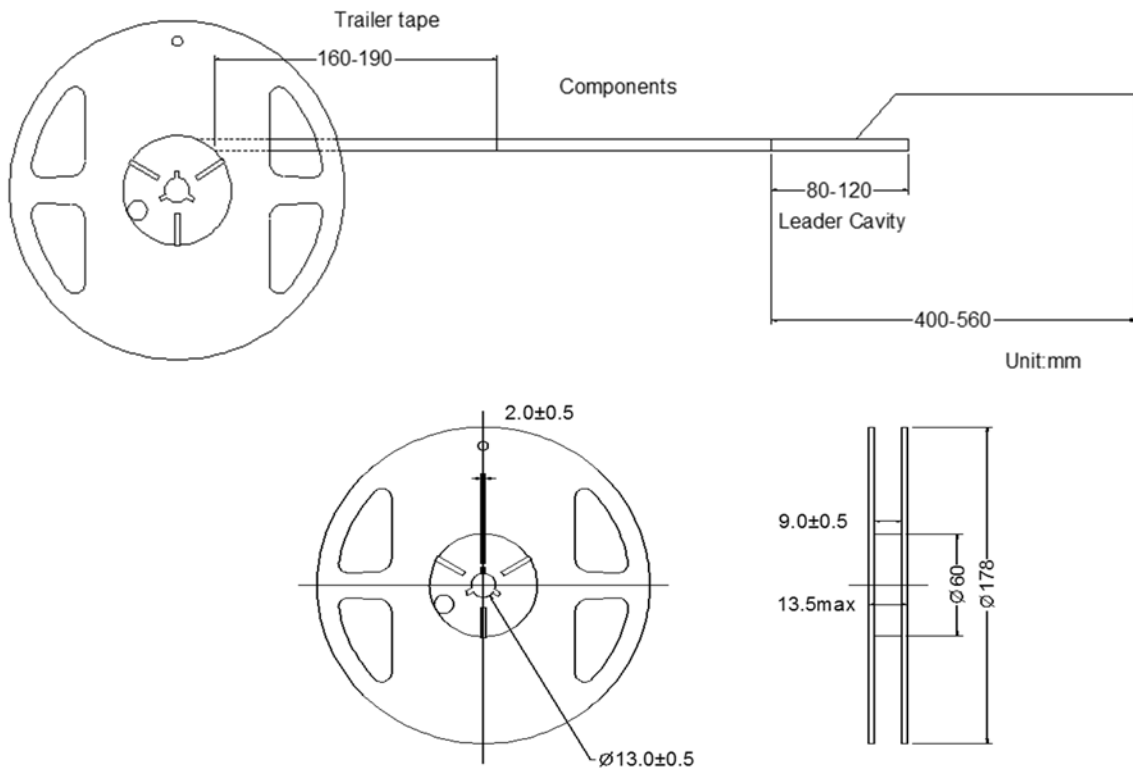

4000Pcs/Reel



Recommended IR Reflow Profile

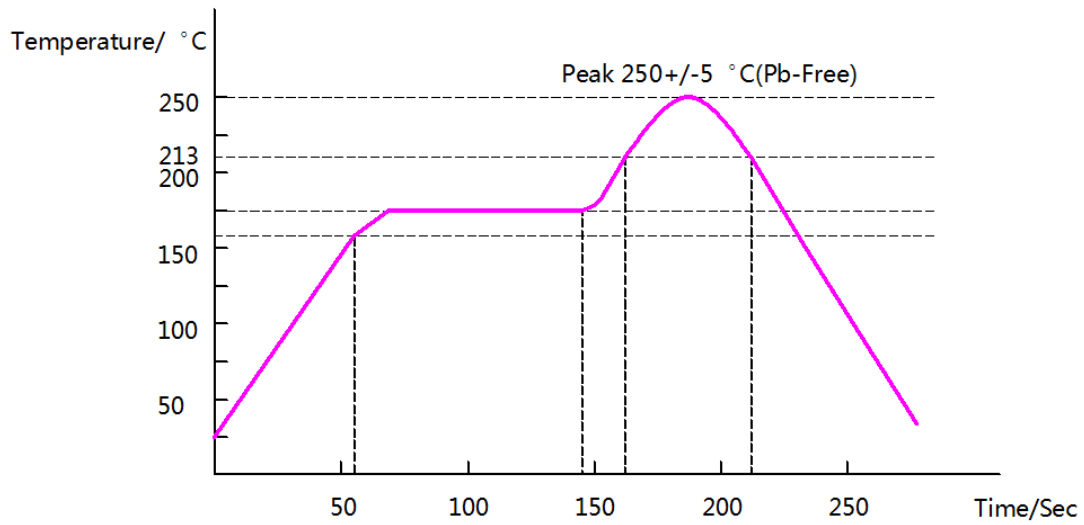

Order Information

Part Number	Qty Per Reel	Container
YTLP2406D	4000	7 inch Reel

