

CLASS No.	TITLE 回転形エンコーダ 規格書 ROTATIONAL ENCODER SPECIFICATION	(SW01)
-----------	---	--------

1. 一般事項 General
- 1-1 適用範囲 Scope  
この仕様書は主として電子機器に用いる微小電流回路用11形薄形ロータリ-エンコーダに適用する。  
This specification applies to 11mm size low-profile rotary encoder (Incremental type) for microscopic current circuits, used in electronic equipment.
- 1-2 標準状態 Standard atmospheric conditions  
測定は特に指定のない限り、次の状態で行なう。  
Unless otherwise specified, the standard range of atmospheric conditions for making measurements and tests is as follows:  
 温度 Ambient temperature : 15°C to 35°C  
 相対湿度 Relative humidity : 25% to 85%  
 気圧 Air pressure : 86kPa to 106kPa  
 但し、疑義を生じた場合は、次の基準状態で行なう。  
 If there is any doubt about the results, measurements shall be made within the following limits:  
 温度 Ambient temperature : 20 ± 1°C  
 相対湿度 Relative humidity : 63% to 67%  
 気圧 Air pressure : 86kPa to 106kPa
- 1-3 使用温度範囲  
Operating temperature range : -40°C to +85°C
- 1-4 保存温度範囲  
Storage temperature range : -40°C to +85°C
2. 構造 Construction
- 2-1 寸法 Dimensions  
添付細直図による。  
Refer to attached drawing.
3. 定格 Rating  
3-1 定格容量 Rating : D.C. 5V 10mA (1mA MIN)
4. 電気的性能 Electrical characteristics

項目 Item	条件 Conditions	規格 Specifications
4-1 出力信号 Output signal format	<Fig 1>	A, B 2信号の位相差出力とし、詳細は <fig. 1>の通りとする。 (破線はクリックの位置を示す。)
		2 Phase-different signals (Signal A, signal B) Details shown in <fig. 1>. (The broken line shows detent position.)
		軸回転方向 Shaft rotational direction
		時計方向 C. W.
	A (A-C端子間) A (Terminal A-C)	OFF ON
	B (B-C端子間) B (Terminal B-C)	OFF ON
	A (A-C端子間) A (Terminal A-C)	OFF ON
	B (B-C端子間) B (Terminal B-C)	OFF ON

# ALPS ELECTRIC CO., LTD.

APPD. 潘・設計試作 06.9.5 池之上	CHKD.	DSGD. 潘・設計試作 06.9.5 清水	TITLE 回転形エンコーダ ROTATIONAL ENCODER
SYMB	DATE	APPD	DOCUMENT NO. 5LA211-E302(1/4)

CLASS No.	TITLE 回転形エンコーダ 規格書 ROTATIONAL ENCODER SPECIFICATION	(SW01)
-----------	---	--------

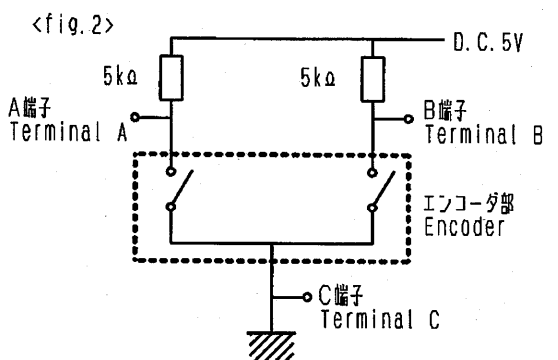
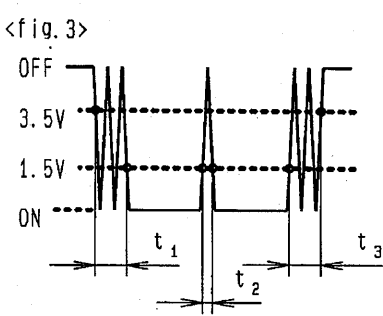
項目 Item	条件 Conditions	規格 Specifications
4-2 分解能 Resolution	1回転にて出力されるパルス数 Number of pulses in 360° rotation.	各相15パルス/360° 15 pulses/360° for each phase  (2クリック 1パルス) (2click 1pulse)
4-3 スwitching特性 Switching characteristics	下記測定回路<fig. 2>を用い、回転軸を360°・s <sup>-1</sup> の速さで回転し測定する。 Measurement shall be made under the condition as follows. 1) Shaft rotational speed : 360°・s <sup>-1</sup> 2) Test circuit. : <fig. 2>    (注記) コードOFF状態 : 出力電圧が3.5V以上の状態を言う。 コードON状態 : 出力電圧が1.5V以下の状態を言う。 (note) Code-OFF area : The area which the voltage is 3.5V or more. code-ON area : The area which the voltage is 1.5V or less.	
1) チャタリング Chattering	コードのOFF→ON及びON→OFFの際の、出力1.5V~3.5Vの通過時間にて規定する。 Specified by the signal's passage time from 3.5V to 1.5V or from 1.5V to 3.5V of each switching position (code OFF→ON or ON→OFF).	$t_1, t_3 \leq 3ms$
2) 摺動ノイズ (バウンス) Sliding noise (Bounce)	コードONの部分の1.5V以上の電圧変動時間とし、チャタリング $t_1, t_3$ 両者との間に1ms以上の1.5V以下のON部分を有するものとする。また、摺動ノイズ間に1.5V以下の範囲が1msある場合は、別の摺動ノイズと判断する。 Specified by the time of voltage change exceed 1.5V in code-ON area. When the bounce has code-ON time less than 1ms between chatterings ( $t_1$ or $t_3$ ), the voltage change shall be regarded as a part of chattering. When the code-ON time between 2 bounces is less than 1ms, they are regarded as 1 linked bounce.	$t_2 \leq 2ms$
3) 摺動ノイズ Sliding noise	コードOFFの部分の電圧変動 The voltage change in code-OFF area.	3.5V以上 3.5V MIN
4-4 接触抵抗 Contact resistance	コモン(C)端子と各端子(A及びB)間のON位置で安定した状態にて測定する。 The contact resistance measures between a common(c) and terminals(A&B) which stables ON contact condition.	1Ω 以下 1Ω max.

# ALPS ELECTRIC CO., LTD.

APPD.	CHKD.	DSGD.	TITLE
通-設計試作 '06.9.-5 池之上		通-設計試作 '06.9.-5 清水	回転形エンコーダ ROTATIONAL ENCODER
1	2010-04-09	Y. K Y. S M. C	DOCUMENT NO.
SYMB	DATE	APPD	CHKD
			5LA211-E302 (2/4)

CLASS No.	TITLE 回転形エンコーダ 規格書 ROTATIONAL ENCODER SPECIFICATION	(SW01)
-----------	---	--------

項目 Item	条件 Conditions	規格 Specifications
4-5 位相差 Phase-difference	<p>360°・s<sup>-1</sup>の定速にて操作軸を回転する。 Measurement shall be made under the condition which the shaft is rotated in 360°・s<sup>-1</sup> (constant speed).</p> <p>&lt;fig. 4&gt;</p> <p>注意事項：摺動接点ですので手動操作時の出力波形はご使用されるツマミ径、軸の回転速度によって変化致します。回路設計時は実装にて確認願います。 Note: Above specification (4-5) is changeable. When operate by manual. Please check performance using actual circuit and knob.</p>	<p>&lt;fig. 4&gt;において ΔT ≥ 6ms In &lt;fig. 4&gt;</p>
4-6 絶縁抵抗 Insulation resistance	<p>端子-軸受間にD. C. 250V印加する。 Measurement shall be made under the condition which a voltage of 250V D. C. is applied between individual terminals and bushing.</p>	<p>端子-軸受間に100MΩ以上 Between individual terminals and bushing: 100MΩ MIN.</p>
4-7 耐電圧 Dielectric strength	<p>端子-軸受間にA. C. 300V1分間又は、A. C. 360V2秒間印加する。 (リーク電流1mA) A voltage of 300V A. C. shall be applied for 1min or a voltage of 360V A. C. shall be applied for 2s between individual terminals and bushing. (Leak current: 1mA)</p>	<p>損傷・アーク・絶縁破壊がないこと。 Without damage to parts, arcing or breakdown.</p>

5. 機械的性能 Mechanical characteristics

項目 Item	条件 Conditions	規格 Specifications
5-1 全回転角度 Total rotational angle		<p>360° (エンドレス) 360° (Endless)</p>
5-2 クリックトルク Detent torque		<p>10 ± 7 mN・m</p>
5-3 クリック点数及び位置 Number and position of detents.		<p>30点クリック 30 detents (ステップ角度 12° ± 3°) (Step angle: 12° ± 3°)</p>
5-4 端子強度 Terminal strength	<p>端子先端の任意の方向に5Nの力を1分間加える。 A static load of 5N be applied to the tip of terminals for 1min in any direction.</p>	<p>端子の破損、著しい力ゝタがないこと。 但し、端子の曲がりは可とする。 Without damage or excessive looseness of terminals. Terminal bend is permitted.</p>

**ALPS ELECTRIC CO., LTD.**

APPD.	CHKD.	DSGD.	TITLE
M-ENG2	M-ENG2	M-ENG2	回転形エンコーダ ROTATIONAL ENCODER
2010-04-09	2010-04-09	2010-04-09	DOCUMENT NO.
加藤	清水	千葉	5LA211-E302 (3/4)
ORG	DATE	APPD	CHKD
2006-09-05	S. I	Y. S	DSGD

CLASS NO.	TITLE 回転形エンコーダ 規格書 ROTATIONAL ENCODER SPECIFICATION	(SW01)
-----------	---	--------

項目 Item	条件 Conditions	規格 Specifications
5-5 軸の押し引き強度 Push-pull strength of shaft	軸の押し及び引張り方向に100Nの力を10秒間加える。 (セット実装状態) Push and pull static load of 100N shall be applied to the shaft in the axial direction for 10s. (After installing)	軸の破損、著しいガタのないこと。 感敏に異常がないこと。 Without damage or excessive play in shaft. No excessive abnormality in rotational feeling.
5-6 軸ガタ Shaft wobble	取付面より30mmの位置に50mN・mの曲げモーメントを加える。 軸長が30mmに満たない場合は右の式による。Lは測定位置(取付面から5の位置)とする。 Bending moment of 50mN・m to be applied to the shaft at 30mm from the mounting surface. If the shaft length is less than 30mm, the value shall be calculated as right formula. L: Measurement point from mounting surface.	軸受長 軸ガタ Bushing Wobble length Wobble (mm) (mmp-p less) → 5 0.8xL/30 7 0.5xL/30 10 0.4xL/30 20 0.25xL/30
5-7 軸のスラスト方向ガタ Shaft play in axial direction		0.4mm以下 0.4mm MAX.
5-8 軸の回転方向ガタ Rotation play at the click position	角度板にて測定する。 Measure with jig for rotational angle.	4°以内 4° MAX.
5-9 取付け上の注意 Notice for mounting	右図の様にスイッチ本体を抑えてご使用下さい。セット側でスイッチ本体の引き及び回転方向の力「イト」が無い場合は、はんだ付けだけの固定となり、はんだ付け信頼性及びスイッチ本体強度が不安定となる可能性があります。 Hold the bushing use front panel or light pipe. Because this switch not has thread. If don't hold the bushing, the switch maybe become intermittent rough mounting after soldering by knob stopper face.	

6. 耐久性能 Endurance characteristics.

項目 Item	条件 Conditions	規格 Specifications
6-1 回転寿命性能 Rotational life	定格負荷で軸を毎時500サイクルの速さで、15,000サイクル断線動作を行う。 但し、試験途中5,000で中間測定を行う。(1サイクルは、360°1往復) The shaft of encoder shall be rotated to 15,000 cycles at a speed of 500cycles per hour with electrical load, after which measurements shall be made. However, an interim measurement shall be made immediately after 5,000 cycles. (1 cycle: rotate 360° CCW rotate 360° CW)	クリックトルクは 初期規格値に対し+10% -30% その他、初期規格を満足すること。 Detent torque: Relative to the previously specified value. +10% -30% Except above items, specifications in clause 4.1~7 and 5.1, 5.3 shall be satisfied.

<b>ALPS ELECTRIC CO., LTD.</b>					
APPD.	CHKD.	DSGD.	TITLE 回転形エンコーダ ROTATIONAL ENCODER		
M-ENG2 2010-04-09 加藤	M-ENG2 2010-04-09 清水	M-ENG2 2010-04-09 千葉	DOCUMENT NO. 5LA211-E302 (4/4)		
ORG	DATE	APPD	CHKD	DSGD	
SYMB					

CLASS NO.	TITLE プッシュモーメンタリスイッチ規格書 PUSH MOMENTARY SWITCH SPECIFICATION	(SW02)
-----------	---	--------

1. 定格容量 (抵抗負荷)  
Switch rating (Resistor load) D. C. 5V 10mA (500μA MIN)

2. 電気的性能 Electrical characteristics

項目 Item	条件 Conditions	規格 Specifications
2-1 接触抵抗 Contact resistance	D. C. 5V1mA電圧降下法にて測定する。 Measured by the 1mA 5V D.C. voltage drop method.	100mΩ MAX.
2-2 チャタリング Chattering	1サイクル (OFF-ON-OFF) 1秒で動作させる。 Switch is operated at the rate of 1 cycle 1s. The 1 cycle shall be OFF-ON-OFF.	10ms以下 Less than 10ms
2-3 絶縁抵抗 Insulation resistance	端子-軸受, 端子間D. C. 250V印加する。 Measurement shall be made under the condition which a voltage of 250VD.C. is applied between individual terminals and bushing, terminal.	端子-軸受, 端子間にて100MΩ以上 Between individual terminals and bushing, terminal: 100MΩ MIN.
2-4 耐電圧 Dielectric strength	端子-軸受, 端子間A. C. 300V1分間又は, A. C. 360V2秒間印加する。 (リーク電流1mA) A voltage of 300VA.C. shall be applied for 1min or a voltage of 360VA.C. shall be applied for 2s between individual terminals and bushing, terminal. (Leak current:1mA)	損傷・アーク・絶縁破壊がないこと。 Without damage to parts, arcing or breakdown.

注記: 軸・スイッチ端子間は絶縁されております。  
Note: Shaft is insulated from switch terminal.

3. 機械的性能 Mechanical characteristics

項目 Item	条件 Conditions	規格 Specifications
3-1 スイッチ回路・接点数 Contact arrangement		単極単投 (Push on) S. P. S. T. (Push on)
3-2 スイッチ移動量 Switching stroke		0.5±0.3mm
3-3 スイッチ作動力 Switch operation force		6±2.5N

4. 耐久性能 Endurance characteristics.

項目 Item	条件 Conditions	規格 Specifications
4-1 動作寿命特性 Operating life	定格負荷にて軸を毎時500回の速さで20,000回断続動作を行う。 但し、試験途中5,000で中間測定を行う。押し圧: 10N以下 The shaft of switch shall be 20,000 times at a speed of 500times per hour with electrical load, after which measurements shall be made. However, an interim measurement shall be made immediately after 5,000 times. Push force:10N MAX.	接触抵抗: 200mΩ以下 その他、初期規格を満足すること。 Switch contact resistance: 200mΩMAX. Except above items, specifications in clause 2.2~4, and 3.1~3 shall be satisfied.

5. その他 Note

5-1 軸にツマミを取り付け、センターから10mmの位置で押しを時にひっきり感が無いこと。  
No sticky feel shall be observed when the knob on the shaft is pushed at 10mm off the center.

6. 注意事項 Note

6-1 プッシュスイッチ付きのエンコーダは、軸が押されたままの状態では梱包や保管をされず、スイッチ部に支障をきたす恐れがありますのでご配慮下さい。  
Encoder equipped with a push-on switches are packaged or stored with their shafts being pushed-in, the switch part may be out of order and pay attention when you package or store them.

					<b>ALPS ELECTRIC CO., LTD.</b>					
					APPD. M-ENG2	CHKD. M-ENG2	DSGD. M-ENG2	TITLE プッシュモーメンタリスイッチ PUSH MOMENTARY SWITCH		
					Y. KATO	Y. SHIMIZU	M. CHIBA	DOCUMENT NO.		
SYMB	DATE	APPD	CHKD	DSGD	2010-02-05	2010-02-05	2010-02-05	5LA2114-E83 (1/1)		

CLASS No.	TITLE
-----------	-------

1. はんだ耐熱 Resistance to soldering heat

下記の“はんだ付け条件”にて絶縁体の変形、破損のないこと。感熱に異常のないこと。  
 At the specified by the soldering conditions below.  
 There shall be no deformation or cracks, in molded part.  
 No excessive abnormality in rotational feeling.

はんだ付け条件 Soldering conditions

手はんだの場合 Manual soldering

温度350°C以下、時間3秒以内  
 Bit temperature of soldering iron : 350°C or less.  
 Application time of soldering iron : within 3s.

ディップはんだの場合 Dip soldering

使用基板 : t1.6両面銅張積層板  
 Printed wiring board: Both-sided copper clad laminate board with thickness of 1.6mm.

フラックス : 比重0.82以上のフラックスを用い発泡式フラクサーにて発泡面高さは、基板厚の3分の2。

Flux:  
 ・Specific gravity: 0.82 or more.  
 ・Flux shall be applied to the board using a bubble foaming type fluxer.  
 ・The board shall be soaked in the flux bubble only to the 2/3 of its thickness.

プリヒート : 基板表面温度110°C以下、時間50秒以内  
 Preheating:  
 ・Surface temperature of board: 110°C or less.  
 ・Preheating time: within 50 sec.

はんだ : 温度260±5°C、時間8±1秒  
 Soldering:  
 ・Solder temperature: 260±5°C.  
 ・Immersion time: within 8±1s.

以上の工程を1回または2回通過する。  
 Apply the above soldering process for 1 or 2 times.

**ALPS ELECTRIC CO., LTD.**

					APPD.	CHKD.	DSGD.	TITLE
					M-ENG2	M-ENG2	M-ENG2	
					Y. KATO	Y. SHIMIZU	M. CHIBA	DOCUMENT NO.
SYMB	DATE	APPD	CHKD	DSGD	2010/02/10	2010/02/10	2010/02/10	L-E49 (1/1)

注記 軸受材質:亜鉛ダイキャスト  
軸材質:アルミニウム  
NOTES BUSHING MATERIAL: ZINC ALLOY DIE CASTING  
SHAFT MATERIAL: ALUMINUM

(SW01) ENCODER  
(SW02) PUSH ON SW

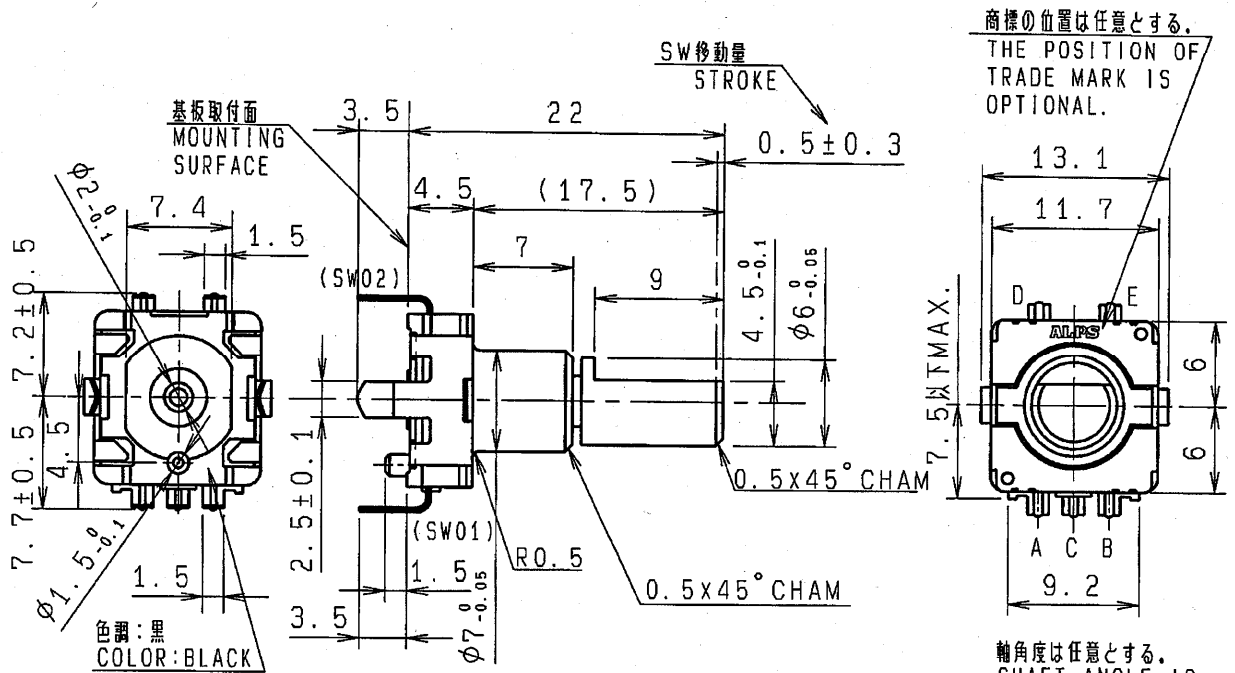

取付穴寸法図 許容差±0.1  
(部品挿入側)  
P.W.B. MOUNTING DETAIL  
TOLERANCE±0.1  
VIEWED FROM MOUNTING SIDE

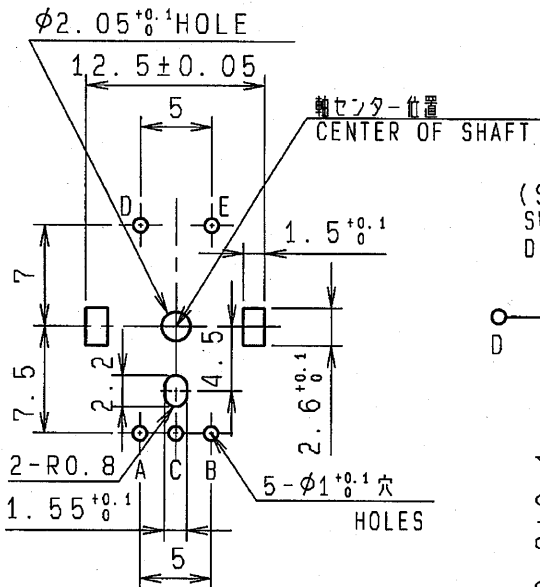

(SW02)回路図  
SWITCH CIRCUIT DIAGRAM

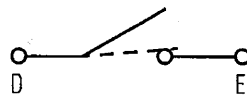

A-C端子間  
TERMINAL A-C  
B-C端子間  
TERMINAL B-C

(SW01)出力信号  
ENCODER OUTPUT SIGNAL

時計方向回転  
CW ROTATION

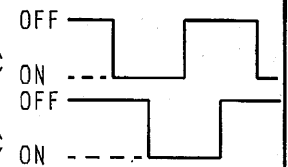

基板挿入部端子形状詳細(3:1)  
TERMINAL DETAIL

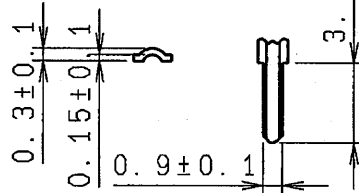

指定なき部分の許容差 TOLERANCES UNLESS OTHERWISE SPEC	
$L \leq 10$	±0.3
$10 < L < 100$	±0.5
$100 \leq L$	±0.8
角度 ANGULAR DIMENSION	±5°

基板板厚 t=1.6mm  
P.C.B. THICKNESS t=1.6mm

15P/30C

PART NO.	NAME	MATERIAL NAME / CODE	FINISH
<b>ALPS ELECTRIC CO., LTD.</b>			
DSGD.	M. CHIBA	2010-02-05	SCALE 2:1
NO.	CHKD.	Y. SHIMIZU	2010-02-05
TITLE	11形1軸 PUSH ON SW付エンコーダ 組立図		
UNIT	APPD.	Y. KATO	2010-02-05
DOCUMENT NO.	LA2115EA8		
SYMB	DATE	APPD	CHKD
		DSGD	