

Features

- Surface Mounting Design 7.6×5.0×5.8mm
- High Current Handling Capability 5,000A @ 8/20 μ s
- Low Capacitance and Insertion Loss
- Quick Response and Long Service Life
- Moisture sensitivity level: Level 1

Exterior

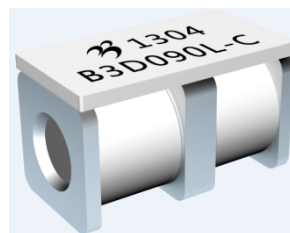

SMD

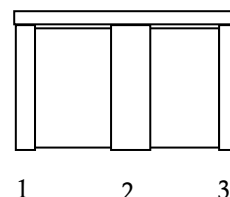

Package (Top View)



Application information

- RS485/232/422

Agency Approvals

Icon	Description
RoHS	Compliance with 2011/65/EU
HF	Compliance with IEC61249-2-21:2003
	Mean lead free
	UL Certificated E232249

Schematic Symbol

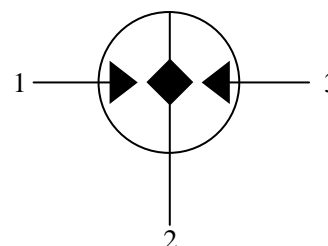

Electrical Parameter

DC Breakdown Voltage 1)2)	100V/s	68-112	V
Impulse Spark-over Voltage	At 1kV/μs	for 99 % of measured values	≤ 700
	At 1kV/μs	Typical values of distribution	≤ 600
Impulse Discharge Current 3)	8/20μs	5,000	A
Arc Voltage	At 1A	~8	V
Insulation Resistance	DC=50V	≥1	GΩ
Capacitance at 1MHz	VDC=0.5V	≤1.5	pF
Weight		~1.1	g
Operating And Storage Temperature		-40-90	°C
Marking		Bencent Logo YY MM B3D090L-C (YY: year of production, MM: month of production)	

1) At delivery AQL 0.65 level II GB/T 2828.1-2003

2) In ionized mode

3) Terms and waveforms in accordance with ITU-T Rec. K. 12; IEC 61643-21

Gas Discharge Tube

Version: A0 2013-09-17

Part Numbering System

B3D 090 L -C

(1) (2) (3) (4)

(1) Bencent 3-Electrode SMD Gas Discharge Tube
7.6×5.0×5.8mm

(2) DC Breakdown Voltage, e.g., 090=90V

(3) Surge Rating @8/20 μs, L=5,000A (Total Impulse
Discharge Current 5,000A @ 8/20 μs)

(4) “-C” Means it is Suitable for High-Speed SMT

Product Characteristics

Lead Material	Copper
Body Material	Ceramics
Terminal Finish	100% Matte-Tin Plated

Environmental Reliability Characteristics

Testing items	Technical standards
High Temperature Storage Test	Temperature: 85°C Time:2H
Low Temperature Storage Test	Temperature: -40°C Time:2H
Vibration	Frequency: 10-500Hz Amplitude: 0.15mm Time: 45min
Resistance of soldering heat	Temperature: 260±5°C Time of dip soldering: 10s, 1time

Note: Up-screen program can be specified by customer's request via contacting Bencent service

Solderability test

Solderability	Solder Pot Temperature:	245°C ± 5°C
	Solder Dwell Time:	4-6 seconds

Product Dimensions

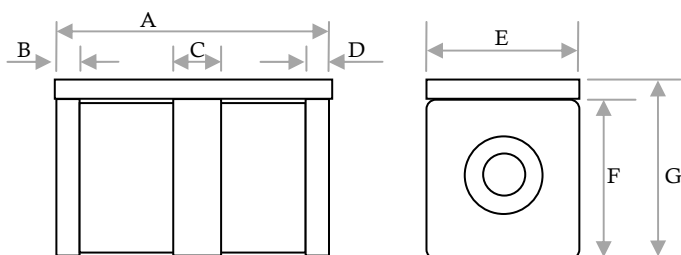

REF	mm	inch
A	7.6±0.3	0.299±0.012
B	0.5±0.2	0.020±0.008
C	1.6±0.2	0.063±0.008
D	0.5±0.2	0.020±0.008
E	5.0±0.2	0.197±0.008
F	5.0±0.2	0.197±0.008
G	5.8±0.3	0.228±0.012

Recommended Soldering Pad

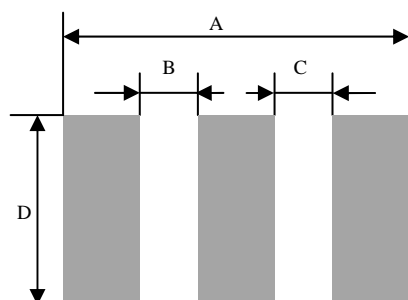

REF	mm	inch
A	9.6	0.378
B	1.5	0.059
C	1.5	0.059
D	5.0	0.197

Reflow Profile

Reflow Condition		Pb-Free assembly
Pre Heat	Temperature Min	150°C
	Temperature Max	200°C
	Time (min to max)	60 – 180 secs
Average ramp up rate (Liquids) Tmp (T _L) to peak		3°C/second max
T _S (max) to T _L - Ramp-up Rate		3°C/second max
Reflow	- Temperature (T _L) (Liquids)	217°C
	- Temperature (T _L)	60 – 150 seconds
Peak Temperature (T _P)		260±0/-5 °C
Time within 5°C of actual peak Temperature (t _p)		~10 seconds
Ramp-down Rate		6°C/second max
Time 25°C to peak Temperature (T _P)		8 minutes Max.
Do not exceed		260°C

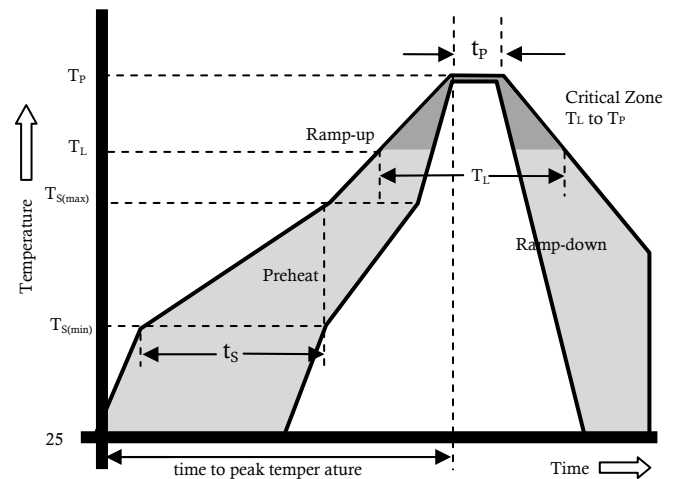

Package Reel Information

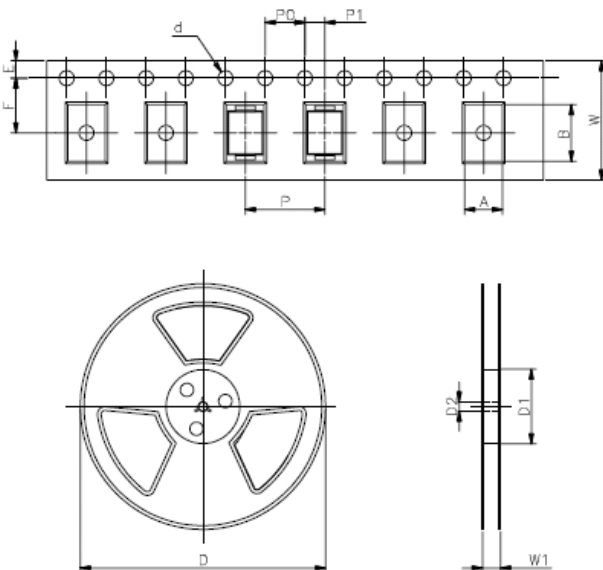

REF	mm	inch
A	5.4±0.1	0.216±0.004
B	8.4±0.1	0.331±0.004
d	Φ 1.5±0.1	Φ 0.059±0.004
P0	4.0±0.1	0.157±0.004
P1	2.0±0.1	0.079±0.004
P	8.0±0.1	0.315±0.004
E	1.75±0.1	0.069±0.004
F	7.5±0.1	0.295±0.004
W	16.0±0.3	0.630± 0.012
D	Φ 330.0	Φ 13.0
D1	Φ 50Min	Φ 1.97Min
D2	Φ 13±0.15	0.512±0.006
W1	16.8±2.0	0.661±0.079

Outline	Reel (PCS)	Per Carton (PCS)	Reel Diameter (mm)	Carton Size(mm)		
				L	W	H
TAPING	1,000	16,000	330	360	360	380