

G6J-Y

Surface-mounting Relay



Ultra-compact and Slim DPDT Relay

- Suitable for high-density mounting.(5.7 mm (W) × 10.6 mm (L) × 9 mm (H)).
- Dielectric strength of 1,500 VAC and an impulse withstand voltage of 2,500 V for 2 × 10 μs (conforms to Telcordia specifications (formerly Bellcore)).
- Conforms to FCC Part 68 (1,500 V, 10 × 160 μs).
- Single-winding latching models to save energy.
- Standard models conforms to UL/C-UL standards.

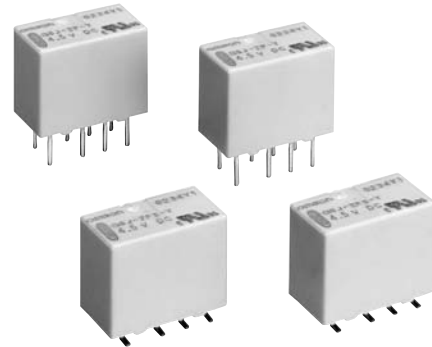

RoHS Compliant

Model Number Legend

G6J \square - \square \square - \square
1 2 3 4

1. Relay function

- None : Single-side stable relay
- U : Single-winding latching relay

2. Number of contact poles/ Contact form

2: 2-pole/DPDT (2c)

3. Terminal Shape

- P : PCB terminals
- FS: Surface-mounting terminals, short
- FL: Surface-mounting terminals, long

4. Special function

Y: Improved product for soldering heat resistance

Application Examples

- Communication equipment
- Test & measurement equipment
- Office automation equipment
- Audio-visual products
- Security equipment
- Building automation equipment
- Industrial equipment
- Amusement equipment

G
6
J
Y

Ordering Information

Relay Function	Protective Structure	Contact form	Tube Packing			Tape Packing				
			Model	Rated coil voltage	Minimum packing unit	Model	Rated coil voltage	Minimum packing unit	Minimum ordering unit (tape packing)	
Single-side stable	Fully sealed	DPDT (2c)	G6J-2P-Y	3 VDC	50 pcs/tube	-	3 VDC	400 pcs/reel	800 pcs/2 reels	
				4.5 VDC			4.5 VDC			
				5 VDC			5 VDC			
				12 VDC			12 VDC			
				24 VDC			24 VDC			
			G6J-2FS-Y G6J-2FL-Y	3 VDC			G6J-2FS-Y-TR G6J-2FL-Y-TR			3 VDC
				4.5 VDC						4.5 VDC
				5 VDC						5 VDC
				12 VDC						12 VDC
				24 VDC						24 VDC
Single-winding latching	Fully sealed	DPDT (2c)	G6JU-2P-Y	3 VDC	50 pcs/tube	-	3 VDC	400 pcs/reel	800 pcs/2 reels	
				4.5 VDC			4.5 VDC			
				5 VDC			5 VDC			
				12 VDC			12 VDC			
				24 VDC			24 VDC			
			G6JU-2FS-Y G6JU-2FL-Y	3 VDC			G6JU-2FS-Y-TR G6JU-2FL-Y-TR			3 VDC
				4.5 VDC						4.5 VDC
				5 VDC						5 VDC
				12 VDC						12 VDC
				12 VDC						12 VDC

Note 1. When ordering, add the rated coil voltage to the model number.

Example: G6J-2P-Y \square DC3
Rated coil voltage

However, the notation of the coil voltage on the product case as well as on the packing will be marked as \square VDC.

Note 2. When ordering tape packing, add "-TR" to the model number.

Be sure since "-TR" is not part of the relay model number, it is not marked on the relay case.

When ordering tape packing, minimum order unit is 2 reels (400 pcs × 2 = 800 pcs).

Note 3. Surface mounting terminal (SMT) standard models are shipped in moisture-proof package.

PCB terminal standard types do not require moisture proof packaging and therefore shipped in non-moisture-proof package.

■ Ratings

● Coil: Single-side Stable Relays (G6J-2P-Y, G6J-2FS-Y, G6J-2FL-Y)

Item	Rated current (mA)	Coil resistance (Ω)	Must operate voltage (V)	Must release voltage (V)	Max. voltage (V)	Power consumption (mW)
			% of rated voltage			
Rated voltage						
3 VDC	48.0	62.5	75% max.	10% min.	150%	Approx. 140
4.5 VDC	32.6	137.9				
5 VDC	28.9	173.1				
12 VDC	12.3	976.8				
24 VDC	9.2	2,600.5				
						Approx. 230

Note 1. The rated current and coil resistance are measured at a coil temperature of 23°C with a tolerance of ±10%.

Note 2. The operating characteristics are measured at a coil temperature of 23°C.

Note 3. The maximum voltage is the highest voltage that can be imposed on the Relay coil instantaneously.

● Coil: Single-winding Latching Relays (G6JU-2P-Y, G6JU-2FS-Y, G6JU-2FL-Y)

Item	Rated current (mA)	Coil resistance (Ω)	Must set voltage (V)	Must reset voltage (V)	Max. voltage (V)	Power consumption (mW)
			% of rated voltage			
Rated voltage						
3 VDC	33.7	89.0	75% max.	75% max.	150%	Approx. 100
4.5 VDC	22.0	204.3				
5 VDC	20.4	245.5				
12 VDC	9.0	1,329.2				

Note 1. The rated current and coil resistance are measured at a coil temperature of 23°C with a tolerance of ±10%.

Note 2. The operating characteristics are measured at a coil temperature of 23°C.

Note 3. The maximum voltage is the highest voltage that can be imposed on the Relay coil instantaneously.

● Contacts

Item	Load	Resistive load
Contact type		Bifurcated crossbar
Contact material		Ag (Au-Alloy)
Rated load		0.3 A at 125 VAC, 1 A at 30 VDC
Rated carry current		1 A
Max. switching voltage		125 VAC, 110 VDC
Max. switching current		1 A

■ Characteristics

Item	Classification	Single-side stable	Single-winding latching
	Model	G6J-2P-Y, G6J-2FS-Y, G6J-2FL-Y	G6JU-2P-Y, G6JU-2FS-Y, G6JU-2FL-Y
Contact resistance *1		100 mΩ max.	
Operating (set) time		3 ms max.	
Release (reset) time		3 ms max.	
Min. set/reset signal width		–	10 ms
Insulation resistance *2		1,000 MΩ min. (at 500 VDC)	
Dielectric strength	Between coil and contacts	1,500 VAC, 50/60 Hz for 1 min	
	Between contacts of different polarity	1,000 VAC, 50/60 Hz for 1 min	
	Between contacts of the same polarity	750 VAC, 50/60 Hz for 1 min	
Impulse withstand voltage	Between coil and contacts	2,500 VAC, 2 × 10 μs	
	Between contacts of different polarity	1,500 VAC, 10 × 160 μs	
	Between contacts of the same polarity		
Vibration resistance	Destruction	10 to 55 to 10 Hz 2.5 mm single amplitude (5 mm double amplitude)	
	Malfunction	10 to 55 to 10 Hz 1.65 mm single amplitude (3.3 mm double amplitude)	
Shock resistance	Destruction	1,000 m/s ²	
	Malfunction	750 m/s ²	
Durability	Mechanical	50,000,000 operations min. (at 36,000 operations/hour)	
	Electrical	100,000 operations min. (with a rated load at 1,800 operations/hour)	
Failure rate (P level) (reference value) *3		10 μA at 10 mVDC	
Ambient operating temperature		-40 to 85°C (with no icing or condensation)	
Ambient operating humidity		5% to 85%	
Weight		Approx. 1.0 g	

Note: The above values are initial values.

*1. The contact resistance was measured with 10 mA at 1 VDC with a fall-of-potential method.

*2. The insulation resistance was measured with a 500 VDC Megger Tester applied to the same parts as those for checking the dielectric strength.

*3. This value was measured at a switching frequency of 120 operations/min and the criterion of contact resistance is 50 Ω. This value may vary depending on the operating frequency, operating conditions, expected reliability level of the relay, etc. Always double-check relay suitability under actual load conditions.

Engineering Data

Maximum Switching Capacity

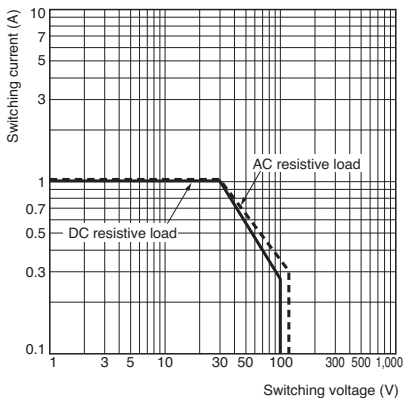

Durability

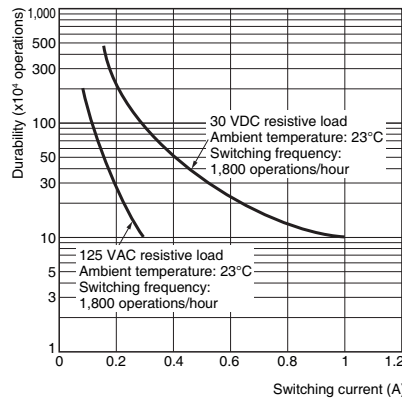

Ambient Temperature vs. Maximum Voltage

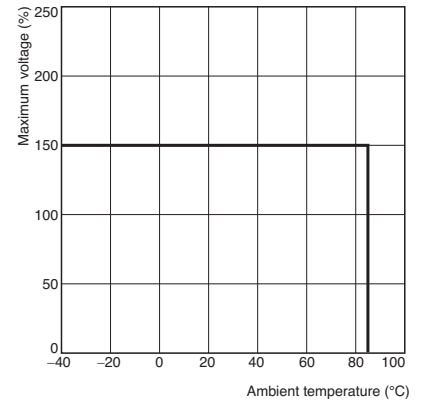

Note: "Maximum voltage" is the maximum voltage that can be applied to the Relay coil.

Ambient Temperature vs. Switching Current

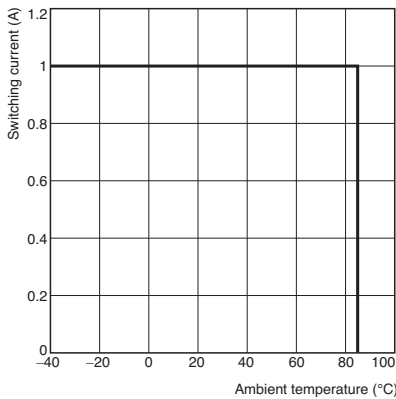

Ambient Temperature vs. Must Operate or Must Release Voltage

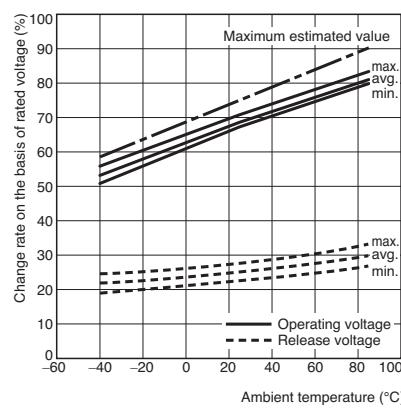

Shock Malfunction

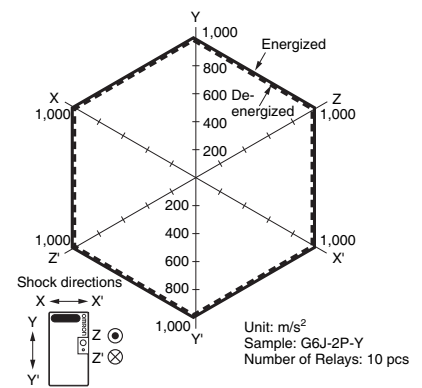

Test Conditions: Shock is applied in $\pm X$, $\pm Y$, and $\pm Z$ directions three times each with and without energizing the Relays to check the number of contact malfunctions.

Electrical Durability (with Operate and Release Voltage) *1

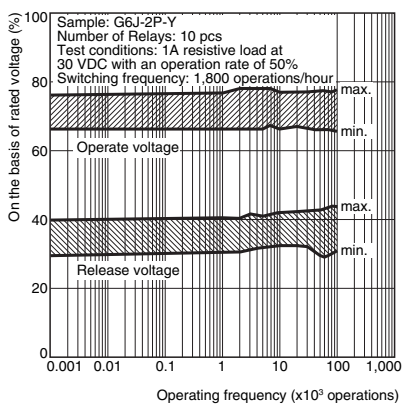

Electrical Durability (Contact resistance) *1

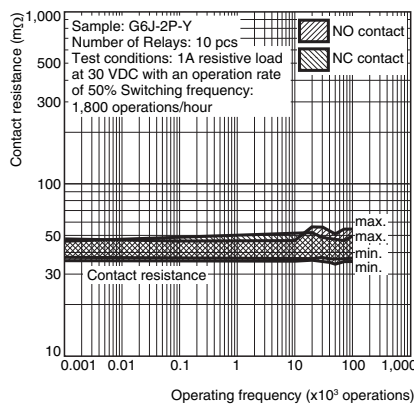

Contact Reliability Test (Contact resistance) *1, *2

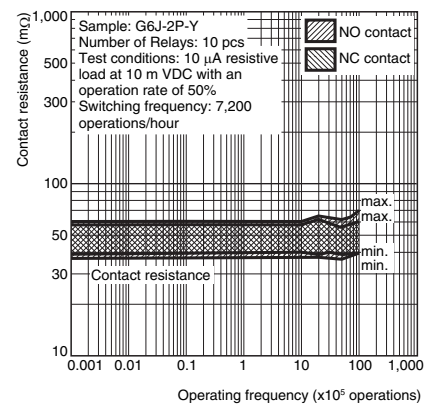

Mutual Magnetic Interference

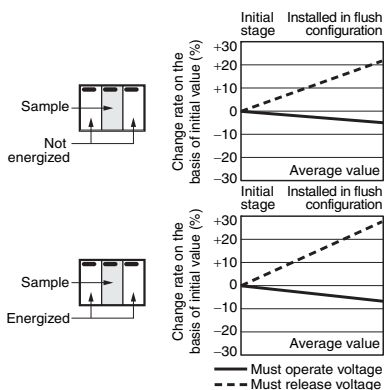

Mutual Magnetic Interference

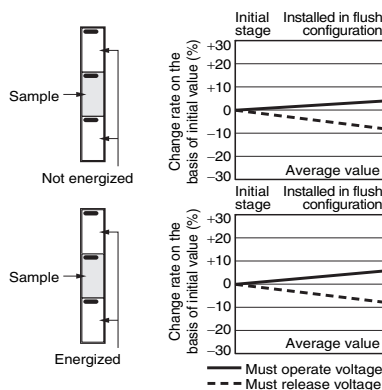

- *1. The tests were conducted at an ambient temperature of 23°C.
- *2. The contact resistance data are periodically measured reference values and are not values from each monitoring operation. Contact resistance values will vary according to the switching frequency and operating environment, so be sure to check operation under the actual operating conditions before use.

G6J-Y

External Magnetic Interference

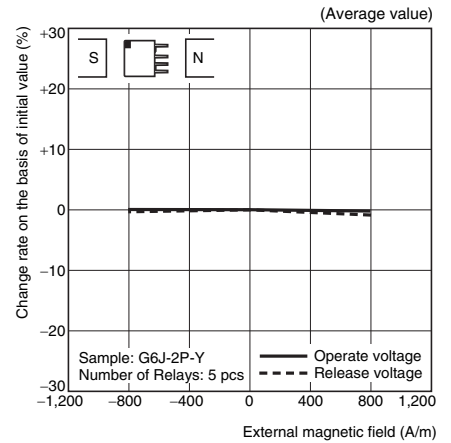
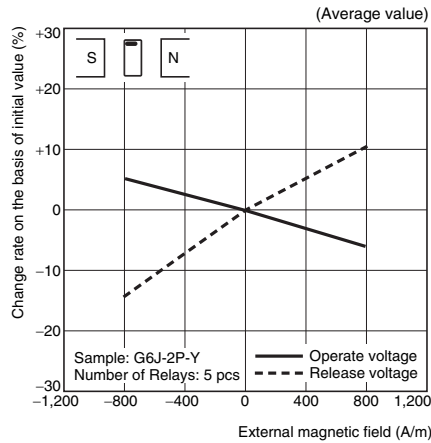
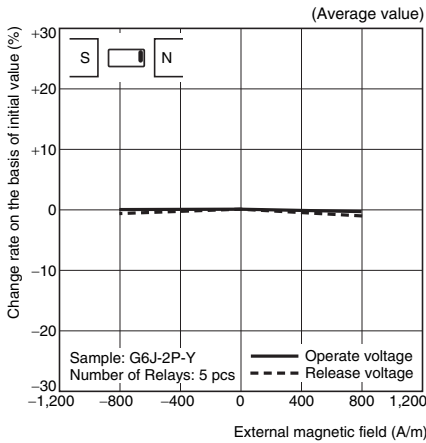

High-frequency Characteristics (Isolation) *1, *2

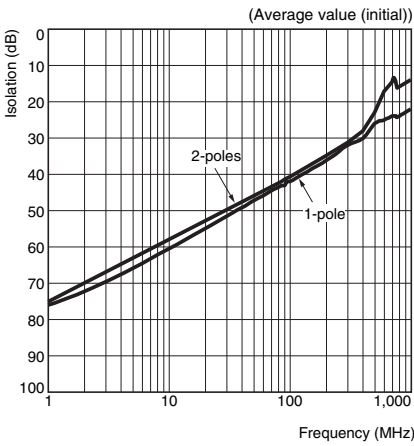

High-frequency Characteristics (Insertion Loss) *1, *2

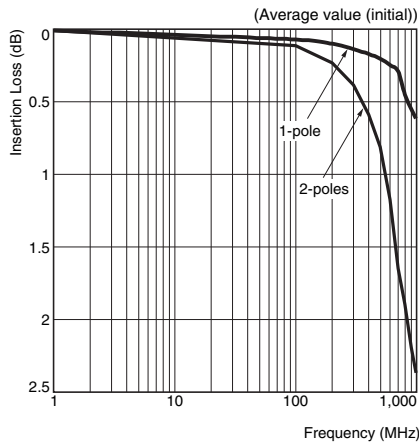

High-frequency Characteristics (Return Loss, V.SWR) *1, *2

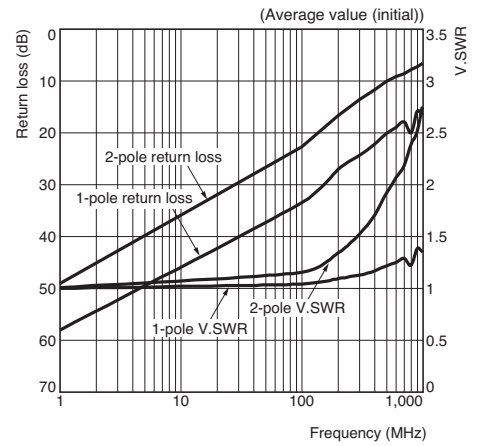

Must Operate and Must Release Time Distribution *1

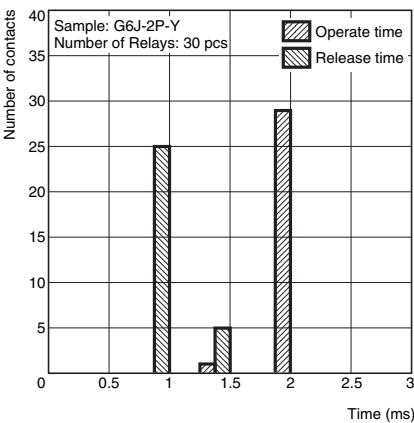

Distribution of Bounce Time *1

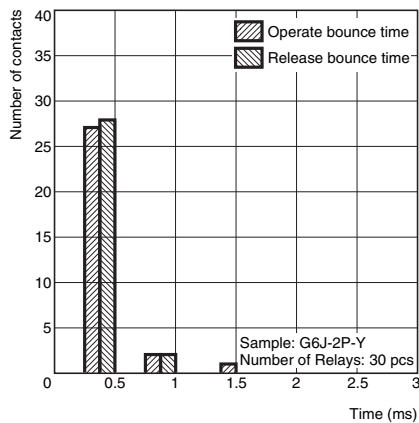

Vibration Resistance

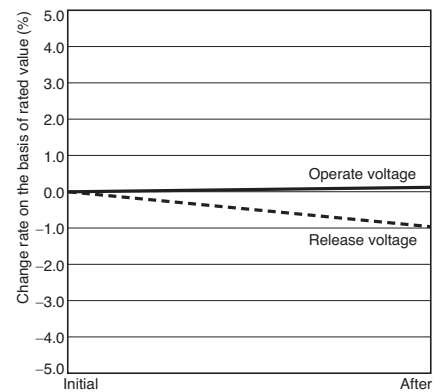

*1. The tests were conducted at an ambient temperature of 23°C.

*2. High-frequency characteristics depend on the PCB to which the Relay is mounted. Always check these characteristics, including endurance, in the actual machine before use.

■Dimensions

(Unit: mm)

PCB Terminals G6J-2P-Y G6JU-2P-Y

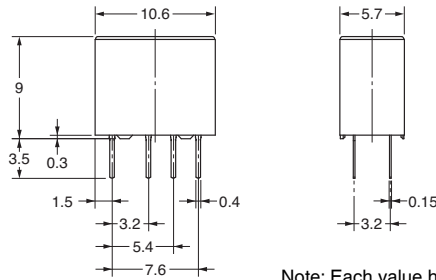
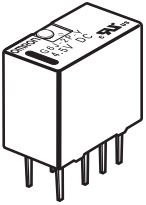

Note: Each value has a tolerance of ± 0.3 mm.

PCB Mounting Holes (BOTTOM VIEW) Tolerance ± 0.1 mm

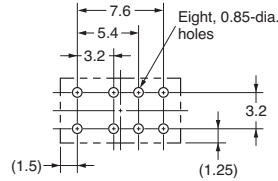

Terminal Arrangement/ Internal Connections (BOTTOM VIEW)

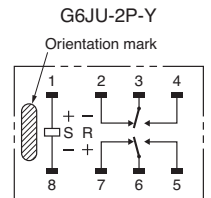
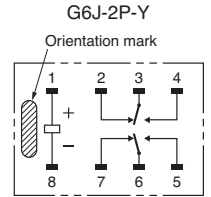

Note: Check carefully the coil polarity of the Relay.

Surface-mounting Terminals (Short) G6J-2FS-Y G6JU-2FS-Y

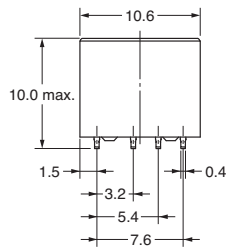
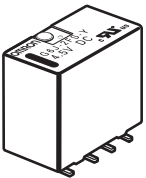

Note 1. Each value has a tolerance of ± 0.3 mm.
Note 2. The coplanarity of the terminals is 0.1 mm max.

Mounting Dimensions (TOP VIEW) Tolerance ± 0.1 mm

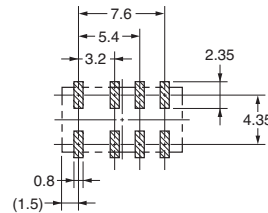

Terminal Arrangement/ Internal Connections (TOP VIEW)

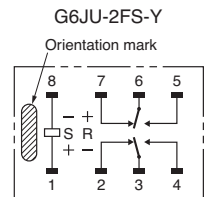
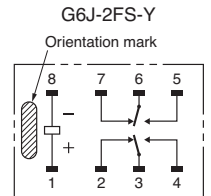

Note: Check carefully the coil polarity of the Relay.

Surface-mounting Terminals (Long) G6J-2FL-Y G6JU-2FL-Y

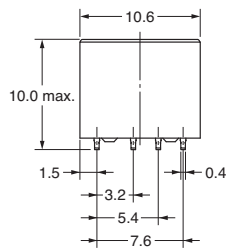
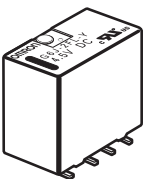

Note 1. Each value has a tolerance of ± 0.3 mm.
Note 2. The coplanarity of the terminals is 0.1 mm max.

Mounting Dimensions (TOP VIEW) Tolerance ± 0.1 mm

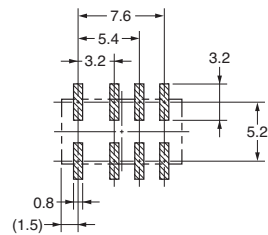

Terminal Arrangement/ Internal Connections (TOP VIEW)

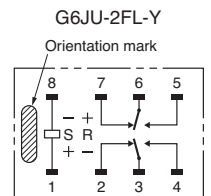
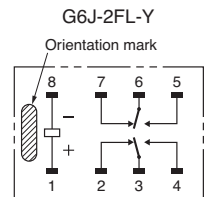

Note: Check carefully the coil polarity of the Relay.

■ Tube Packing and Tape Packing

Surface mounting terminal (SMT) standard models are shipped in moisture-proof package, and PCB terminal standard types do not require moisture proof packaging and therefore shipped in non-moisture-proof package.

Please refer to "Correct Use" for handling after opening moisture-proof packaging for Surface mounting terminal (SMT) models.

(1) Tube Packing

Relays in tube packing are arranged so that the orientation mark of each Relay is on the left side.

Always confirm that the Relays are in the correct orientation when mounting the Relays to the PCBs.

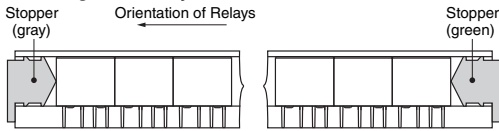

Tube length: 555 mm (stopper not included)

No. of Relays per tube: 50 pcs

(2) Tape Packing (Surface-mounting Terminal Relays)

When ordering Relays in tape packing, add the prefix "TR" to the model number, otherwise the Relays in tube packing will be provided.

Relays per reel: 400 pcs

Minimum ordering unit: 2 reels (800 pcs)

1. Direction of Relay Insertion

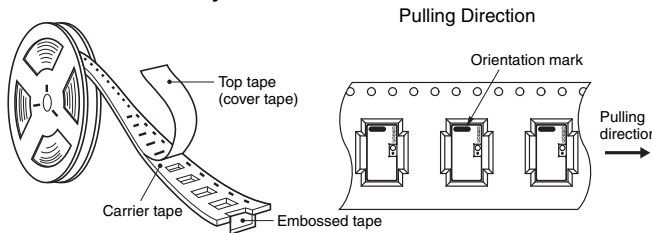

2. Reel Dimensions

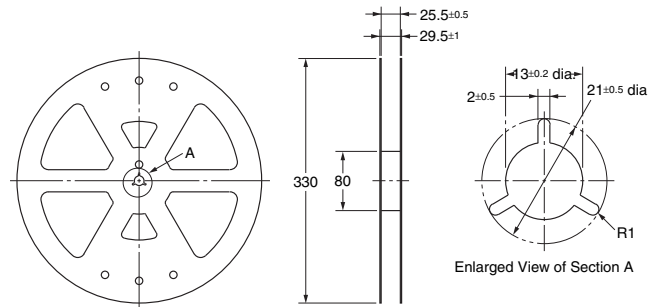

3. Carrier Tape Dimensions

G6J-2FS-Y, G6JU-2FS-Y, G6J-2FL-Y, G6JU-2FL-Y

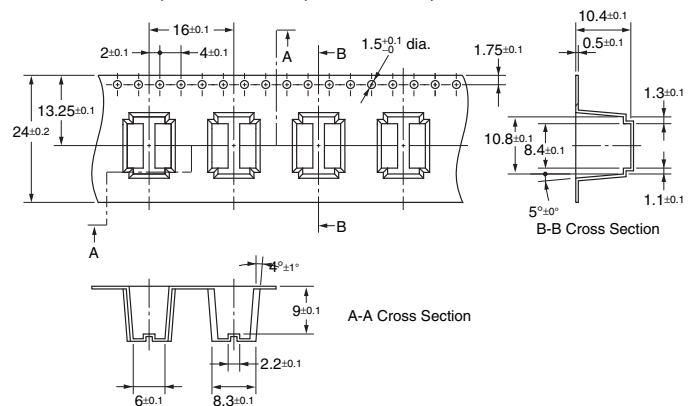

■ Recommended Soldering Method

● IRS Method (for Surface-mounting Terminal Relays)

(1) IRS Method (Mounting Solder: Lead)

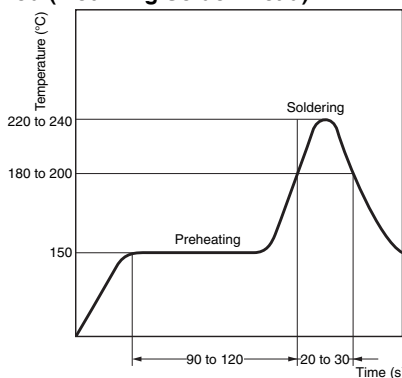

(The temperature profile indicates the temperature on the circuit board.)

(2) IRS Method (Mounting Solder: Lead-free)

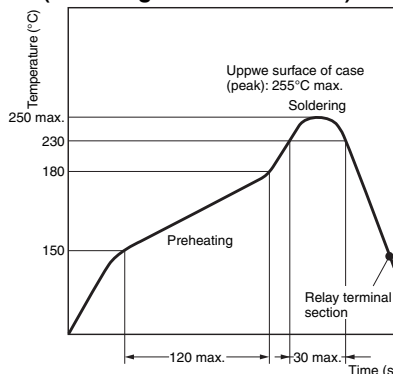

(The temperature profile indicates the temperature on the PCB.)

- The thickness of cream solder to be applied should be between 150 and 200 μm on OMRON's recommended PCB pattern.
- In order to perform correct soldering, it is recommended that the correct soldering conditions be maintained as shown below on the left-hand side.

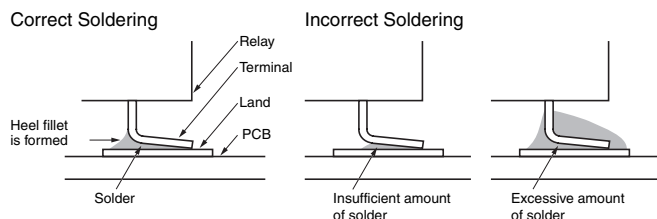

Visually check that the Relay is properly soldered.

Approved Standards

UL/C-UL Recognized.  (File No.E41515)

Contact form	Coil rating	Contact rating	Number of test operations
DPDT (2c)	G6J-2P-Y, 2FS-Y, 2FL-Y: 3 to 24 VDC G6JU-2P-Y, 2FS-Y, 2FL-Y: 3 to 24 VDC	1 A, 30 VDC at 40°C 0.5 A, 60 VDC at 40°C 0.3 A, 125 VAC at 40°C	6,000

Precautions

Please refer to “PCB Relays Common Precautions” for correct use.

Correct Use

Long Term Current Carrying

Under a long-term current carrying without switching, the insulation resistance of the coil goes down gradually due to the heat generated by the coil itself. Furthermore, the contact resistance of the Relay will gradually become unstable due to the generation of film on the contact surfaces. A Latching Relay can be used to prevent these problems. When using a single-side stable relay, the design of the fail-safe circuit provides protection against contact failure and open coils.

Handling of Surface-mounting Relays

- Use the Relay as soon as possible after opening the moistureproof package. (As a guideline, use the Relay within one week at 30°C or less and 60% RH or less.) If the Relay is left for a long time after opening the moisture-proof package, the appearance may suffer and seal failure may occur after the solder mounting process. To store the Relay after opening the moisture-proof package, place it into the original package and sealed the package with adhesive tape.
- When washing the product after soldering the Relay to a PCB, use a water-based solvent or alcohol-based solvent, and keep the solvent temperature to less than 40°C. Do not put the relay in a cold cleaning bath immediately after soldering.

Claw Securing Force During Automatic Insertion

During automatic insertion of Relays, make sure to set the securing force of the claws to the following values so that the Relay characteristics will be maintained.

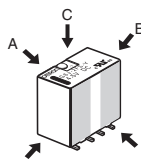

Direction A: 4.90 N max.
Direction B: 9.80 N max.
Direction C: 9.80 N max.

 Secure the claws to the area indicated by shading.

Environmental Conditions During Operation, Storage, and Transportation

Protect the Relays from direct sunlight and keep the Relays under normal temperature, humidity, and pressure.

Mounting Latching Relays

Make sure that the vibration or shock that is generated from other devices, such as Relays in operation, on the same panel and imposed on the Latching Relays does not exceed the rated value, otherwise the Latching Relays that have been set may be reset or vice versa. The Latching Relays are reset before shipping. If excessive vibration or shock is imposed, however, the Latching Relays may be set accidentally. Be sure to apply a reset signal before use.

Maximum Allowable Voltage

- The maximum voltage of the coil can be obtained from the coil temperature increase and the heat-resisting temperature of coil insulating sheath material. (Exceeding the heat-resisting temperature may result in burning or short-circuiting.) The maximum voltage also involves important restrictions which include the following:
 - Must not cause thermal changes or deterioration of the insulating material.
 - Must not cause damage to other control devices.
 - Must not cause any harmful effect on people.
 - Must not cause fire.
- Therefore, be sure not to exceed the maximum voltage specified in the catalog.
- As a rule, the rated voltage must be applied to the coil. A voltage exceeding the rated value, however, can be applied to the coil provided that the voltage is less than the maximum voltage. It must be noted that continuous voltage application to the coil will cause a coil temperature increase thus affecting characteristics such as electrical life and resulting in the deterioration of coil insulation.

Coating

Relays mounted on PCBs may be coated or washed. Do not apply silicone coating or detergent containing silicone, otherwise the silicone coating or detergent may remain on the surface of the Relays.

Other Handling

Please don't use the relay if it suffered the dropping shock. Because there is a possibility of something damage for initial performance.

• Application examples provided in this document are for reference only. In actual applications, confirm equipment functions and safety before using the product.
• Consult your OMRON representative before using the product under conditions which are not described in the manual or applying the product to nuclear control systems, railroad systems, aviation systems, vehicles, combustion systems, medical equipment, amusement machines, safety equipment, and other systems or equipment that may have a serious influence on lives and property if used improperly. Make sure that the ratings and performance characteristics of the product provide a margin of safety for the system or equipment, and be sure to provide the system or equipment with double safety mechanisms.

Note: Do not use this document to operate the Unit.