

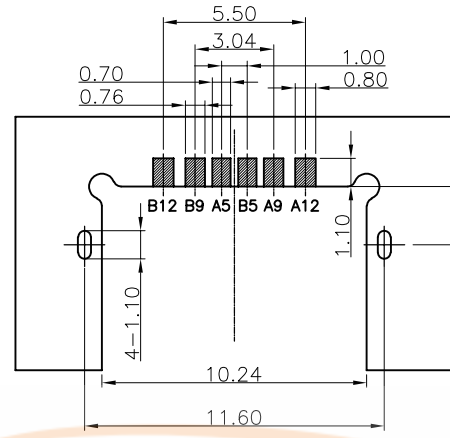

REV.	ECN NO.	DESCRIPTION	DRAW	APPD.	DATE
A	---	新版本发行			

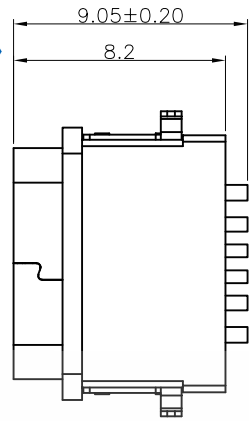
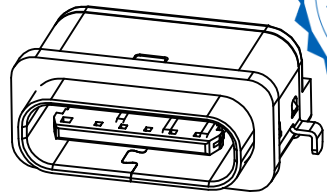

NOTES:

SPECIFICATION:

1. CURRENT RATING: 3.0A MAX
2. VOLTAGE: 100 VAC
3. TEMPERATURE RANGE: -30 °C ~ 85 °C
4. CONTACT RESISTANCE: 40 MILLIONHM MAX
5. INSULATION RESISTANCE: 100 MEGOHMS MIN.
6. INSERTION FORCE : 5N~20N
7. UNMATING FORCE: 8N~20N
8. DURABILITY: 10,000 CYCLES
9. WATER PROOFNESS: THIS PRODUCT IS BASED ON IPX7.

RECOMMENDED P.C.B. LAYOUT  
TOLERANCE UNSPECIFIED ±0.05mm

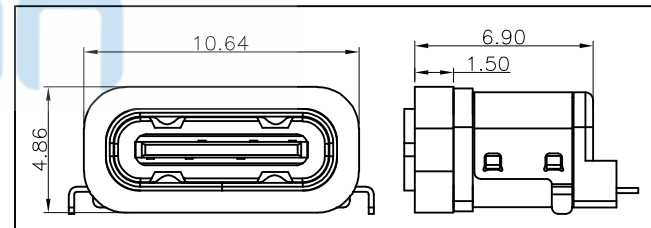
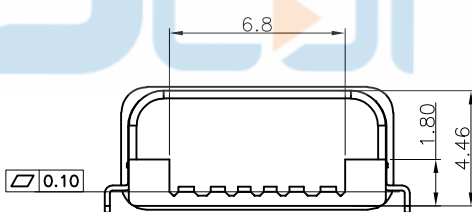
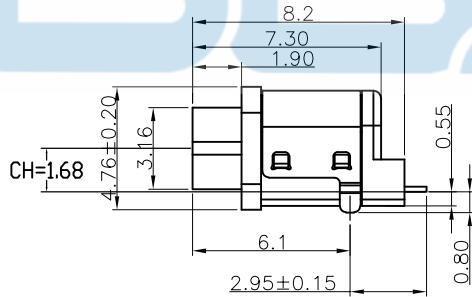
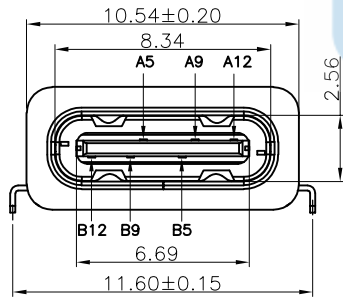

加防水圈示意图

备注:

NO.	料号	备注
1		不带硅胶
2		带硅胶

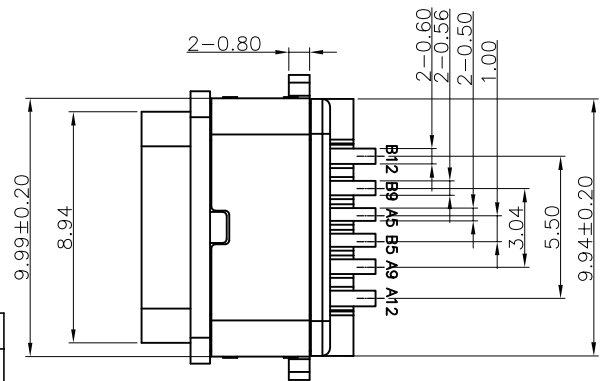

PIN	SIGNAL NAME	PIN	SIGNAL NAME
A5	CC1	B12	GND
A9	VBUS	B9	VBUS
A12	GND	B5	CC2

NO.	DESCRIPTION	MATERIAL	REMARKS	QTY
5	SHELL	STAINLESS STEEL	NI Plated	1PCS
4	SHIELDING PLATE	STAINLESS STEEL	NI Plated	1PCS
3	CONTACT	COPPER ALLOY	TIN/Au/NI Plated	1SET
2	SHELL HOUSING	HIGH TEMPERATURE PLASTIC	BLACK	1PCS
1	HOUSING	HIGH TEMPERATURE PLASTIC	BLACK	1PCS

TOLERANCE		NAME(INTENDED USE)	深圳市步步精科技有限公司		
X.X ±0.20	X.* ± 2*	CJSTOMER DPAING	TITLE:		
.XX ±0.10	.X* ± 1*		0395-1		
.XXX ±0.05	.XX* ±0.5*		TYPE-C 6P 母座 防水侧插沉板 0.55 L=8.20 IPX7 CH=1.68		
UNITS	mm	APPD:	LJP	PART NO. UC.01.53-1J-0004	
MATERILA		CHED:	LYX		
FINISH		DRAW:	HMY		

SCALE	SHEET	REV.
1:1	1/1	A



REV.	ECN NO.	DESCRIPTION	DRAW	APPD.	DATE
A	---	新版本发行 (INITIAL EDITION)			

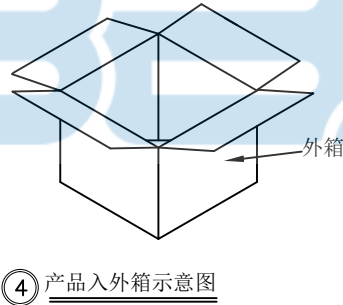
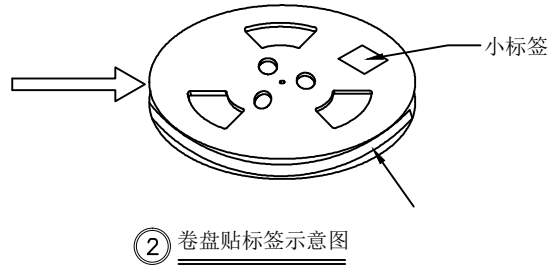
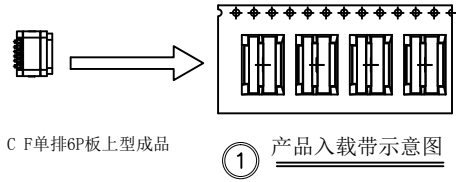

NOTE:

- QUANTITY/REEL: 700 PCS  
数量/卷: 700 PCS  
QUANTITY/INNER CARTON: 700 X 10 = 7000 PCS  
数量/箱: 700 X 10 = 7000 PCS
- FREE 20 CAVE IN THE FRONT CARRIER AND FREE 20 CAVE IN THE END CARRIER.  
包装带内圈空20格, 外圈空20格.

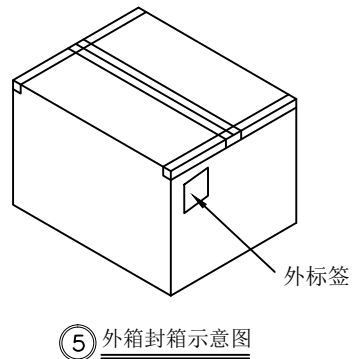

1	成品			
2	CARRIER TAPE	PET	W=24mm T=0.35mm	——
3	COVER TAPE	PET	W=13.3mm T=0.05mm	——
4	小标签		L102mm*W59mm	10
5	卷盘	PS	ø330MM*W28.5MM	10
6	外标签		L102mm*W102mm	1
7	外箱	A=A	L330mm*W330mm*320mm	1
ITEM	DESC.	MATERIAL	REMARKS	QTY
TOLERANCE		NAME (INTENDED USE) 包装规范		深圳市步步精科技有限公司
X.	±0.20	X.*	± 2°	PART NO.
.X	±0.15	.X.*	± 1°	UC.01.53-1J-0004
.XX	±0.10	.XX.*	±0.5°	TITLE:
UNITS	mm	APPD:	LJP	TYPE-C 6P 母座 防水侧脚插沉板0.55 L=8.20 1PX7 CH=1.68
MATERILA		CHED:	LYX	0395-1
FINISH		DRAW:	HMY	SCALE SHEET REV.
				NONE 1/1 A