

- **Input Offset Voltage Drift . . . Typically 0.1 μ V/Month, Including the First 30 Days**
- **Wide Range of Supply Voltages Over Specified Temperature Range:**
 - 0°C to 70°C . . . 3 V to 16 V
 - 40°C to 85°C . . . 4 V to 16 V
 - 55°C to 125°C . . . 4 V to 16 V
- **Single-Supply Operation**
- **Common-Mode Input Voltage Range Extends Below the Negative Rail (C-Suffix, I-Suffix types)**
- **Low Noise . . . Typically 25 nV/ $\sqrt{\text{Hz}}$ at f = 1 kHz**
- **Output Voltage Range Includes Negative Rail**
- **High Input impedance . . . 10¹² Ω Typ**
- **ESD-Protection Circuitry**

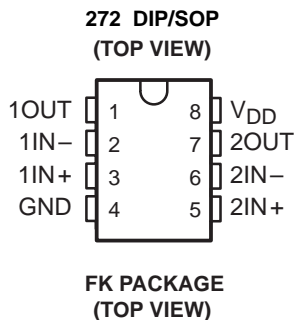

description

The 272 precision dual operational amplifiers combine a wide range of input offset voltage grades with low offset voltage drift, high input impedance, low noise, and speeds approaching that of general-purpose BiFET devices.

equivalent schematic (each amplifier)

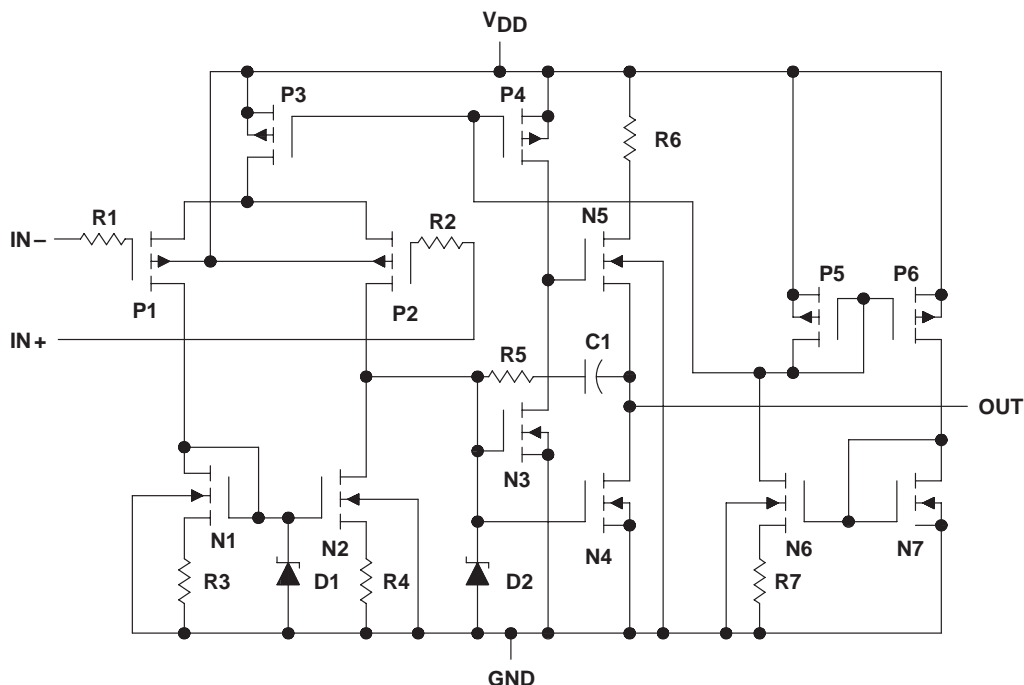

XD272 DIP8 / XL272 SOP8

absolute maximum ratings over operating free-air temperature range (unless otherwise noted)†

Supply voltage, V_{DD} (see Note 1)	18 V
Differential input voltage, V_{ID} (see Note 2)	$\pm V_{DD}$
Input voltage range, V_I (any input)	-0.3 V to V_{DD}
Input current, I_I	± 5 mA
output current, I_O (each output)	± 30 mA
Total current into V_{DD}	45 mA
Total current out of GND	45 mA
Duration of short-circuit current at (or below) 25°C (see Note 3)	unlimited
Continuous total dissipation	See Dissipation Rating Table
Operating free-air temperature, T_A : C suffix	0°C to 70°C
I suffix	-40°C to 85°C
M suffix	-55°C to 125°C
Storage temperature range	-65°C to 150°C
Case temperature for 60 seconds: FK package	260°C
Lead temperature 1,6 mm (1/16 inch) from case for 10 seconds: D, P, or PW package	260°C
Lead temperature 1,6 mm (1/16 inch) from case for 60 seconds: JG package	300°C

† Stresses beyond those listed under “absolute maximum ratings” may cause permanent damage to the device. These are stress ratings only, and functional operation of the device at these or any other conditions beyond those indicated under “recommended operating conditions” is not implied. Exposure to absolute-maximum-rated conditions for extended periods may affect device reliability.

- NOTES: 1. All voltage values, except differential voltages, are with respect to network ground.
 2. Differential voltages are at IN+ with respect to IN-.
 3. The output may be shorted to either supply. Temperature and/or supply voltages must be limited to ensure that the maximum dissipation rating is not exceeded (see application section).

DISSIPATION RATING TABLE

PACKAGE	$T_A \leq 25^\circ\text{C}$	DERATING FACTOR ABOVE $T_A = 25^\circ\text{C}$	$T_A = 70^\circ\text{C}$	$T_A = 85^\circ\text{C}$	$T_A = 125^\circ\text{C}$
	POWER RATING		POWER RATING	POWER RATING	POWER RATING
D	725 mW	5.8 mW/°C	464 mW	377 mW	N/A
FK	1375 mW	11 mW/°C	880 mW	715 mW	275 mW
JG	1050 mW	8.4 mW/°C	672 mW	546 mW	210 mW
P	1000 mW	8.0 mW/°C	640 mW	520 mW	N/A
PW	525 mW	4.2 mW/°C	336 mW	N/A	N/A

recommended operating conditions

		C SUFFIX		I SUFFIX		M SUFFIX		UNIT
		MIN	MAX	MIN	MAX	MIN	MAX	
Supply voltage, V_{DD}		3	16	4	16	4	16	V
Common-mode input voltage, V_{IC}	$V_{DD} = 5$ V	-0.2	3.5	-0.2	3.5	0	3.5	V
	$V_{DD} = 10$ V	-0.2	8.5	-0.2	8.5	0	8.5	
Operating free-air temperature, T_A		0	70	-40	85	-55	125	°C

XD272 DIP8 / XL272 SOP8

electrical characteristics at specified free-air temperature, $V_{DD} = 5\text{ V}$ (unless otherwise noted)

PARAMETER		TEST CONDITIONS	T_A †	XD272 DIP8 XL272 SOP8			UNIT
				MIN	TYP	MAX	
V_{IO} Input offset voltage	272	$V_O = 1.4\text{ V}$, $R_S = 50\ \Omega$,	$V_{IC} = 0$, $R_L = 10\text{ k}\Omega$	25°C	1.1	10	mV
			Full range			12	
		$V_O = 1.4\text{ V}$, $R_S = 50\ \Omega$,	$V_{IC} = 0$, $R_L = 10\text{ k}\Omega$	25°C	0.9	5	μV
				Full range			
		$V_O = 1.4\text{ V}$, $R_S = 50\ \Omega$,	$V_{IC} = 0$, $R_L = 10\text{ k}\Omega$	25°C	230	2000	μV
				Full range			
α_{VIO} Temperature coefficient of input offset voltage			25°C to 70°C	1.8		μV/°C	
I_{IO} Input offset current (see Note 4)		$V_O = 2.5\text{ V}$,	$V_{IC} = 2.5\text{ V}$	25°C	0.1		pA
				70°C	7	300	
I_{IB} Input bias current (see Note 4)		$V_O = 2.5\text{ V}$,	$V_{IC} = 2.5\text{ V}$	25°C	0.6		pA
				70°C	40	600	
V_{ICR} Common-mode input voltage range (see Note 5)				25°C	-0.2 to 4	-0.3 to 4.2	V
				Full range	-0.2 to 3.5		V
V_{OH} High-level output voltage		$V_{ID} = 100\text{ mV}$,	$R_L = 10\text{ k}\Omega$	25°C	3.2	3.8	V
				0°C	3	3.8	
				70°C	3	3.8	
V_{OL} Low-level output voltage		$V_{ID} = -100\text{ mV}$,	$I_{OL} = 0$	25°C	0	50	mV
				0°C	0	50	
				70°C	0	50	
A_{VD} Large-signal differential voltage amplification		$V_O = 0.25\text{ V to }2\text{ V}$,	$R_L = 10\text{ k}\Omega$	25°C	5	23	V/mV
				0°C	4	27	
				70°C	4	20	
CMRR Common-mode rejection ratio		$V_{IC} = V_{ICRmin}$		25°C	65	80	dB
				0°C	60	84	
				70°C	60	85	
k_{SVR} Supply-voltage rejection ratio ($\Delta V_{DD}/\Delta V_{IO}$)		$V_{DD} = 5\text{ V to }10\text{ V}$,	$V_O = 1.4\text{ V}$	25°C	65	95	dB
				0°C	60	94	
				70°C	60	96	
I_{DD} Supply current (two amplifiers)		$V_O = 2.5\text{ V}$, No load	$V_{IC} = 5\text{ V}$,	25°C	1.4	3.2	mA
				0°C	1.6	3.6	
				70°C	1.2	2.6	

† Full range is 0°C to 70°C.

- NOTES: 4. The typical values of input bias current and input offset current below 5 pA were determined mathematically.
5. This range also applies to each input individually.

XD272 DIP8 / XL272 SOP8

electrical characteristics at specified free-air temperature, $V_{DD} = 10\text{ V}$ (unless otherwise noted)

PARAMETER		TEST CONDITIONS		T_A †	XD272 DIP8 XL272 SOP8			UNIT
					MIN	TYP	MAX	
V_{IO}	Input offset voltage	$V_O = 1.4\text{ V}$, $R_S = 50\ \Omega$	$V_{IC} = 0$, $R_L = 10\text{ k}\Omega$	25°C	1.1	10	mV	
				Full range		12		
		$V_O = 1.4\text{ V}$, $R_S = 50\ \Omega$	$V_{IC} = 0$, $R_L = 10\text{ k}\Omega$	25°C	0.9	5	μV	
				Full range		6.5		
		$V_O = 1.4\text{ V}$, $R_S = 50\ \Omega$	$V_{IC} = 0$, $R_L = 10\text{ k}\Omega$	25°C	290	2000	μV	
				Full range		3000		
α_{VIO}	Temperature coefficient of input offset voltage			25°C to 70°C	2		μV/°C	
I_{IO}	Input offset current (see Note 4)	$V_O = 5\text{ V}$	$V_{IC} = 5\text{ V}$	25°C	0.1		pA	
				70°C	7	300		
I_{IB}	Input bias current (see Note 4)	$V_O = 5\text{ V}$	$V_{IC} = 5\text{ V}$	25°C	0.7		pA	
				70°C	50	600		
V_{ICR}	Common-mode input voltage range (see Note 5)			25°C	-0.2 to 9	-0.3 to 9.2	V	
				Full range	-0.2 to 8.5		V	
V_{OH}	High-level output voltage	$V_{ID} = 100\text{ mV}$	$R_L = 10\text{ k}\Omega$	25°C	8	8.5	V	
				0°C	7.8	8.5		
				70°C	7.8	8.4		
V_{OL}	Low-level output voltage	$V_{ID} = -100\text{ mV}$	$I_{OL} = 0$	25°C	0	50	mV	
				0°C	0	50		
				70°C	0	50		
A_{VD}	Large-signal differential voltage amplification	$V_O = 1\text{ V to }6\text{ V}$	$R_L = 10\text{ k}\Omega$	25°C	10	36	V/mV	
				0°C	7.5	42		
				70°C	7.5	32		
CMRR	Common-mode rejection ratio	$V_{IC} = V_{ICRmin}$		25°C	65	85	dB	
				0°C	60	88		
				70°C	60	88		
k_{SVR}	Supply-voltage rejection ratio ($\Delta V_{DD}/\Delta V_{IO}$)	$V_{DD} = 5\text{ V to }10\text{ V}$	$V_O = 1.4\text{ V}$	25°C	65	95	dB	
				0°C	60	94		
				70°C	60	96		
I_{DD}	Supply current (two amplifiers)	$V_O = 2.5\text{ V}$, No load	$V_{IC} = 5\text{ V}$	25°C	1.9	4	mA	
				0°C	2.3	4.4		
				70°C	1.6	3.4		

† Full range is 0°C to 70°C.

NOTES: 4. The typical values of input bias current and input offset current below 5 pA were determined mathematically.

5. This range also applies to each input individually.

XD272 DIP8 / XL272 SOP8

electrical characteristics at specified free-air temperature, $V_{DD} = 5\text{ V}$ (unless otherwise noted)

PARAMETER		TEST CONDITIONS	T_A †	XD272 DIP8 XL272 SOP8			UNIT	
				MIN	TYP	MAX		
V_{IO}	Input offset voltage	$V_O = 1.4\text{ V}$, $R_S = 50\ \Omega$,	$V_{IC} = 0$, $R_L = 10\text{ k}\Omega$	25°C	1.1	10	mV	
				Full range		13		
		272	$V_O = 1.4\text{ V}$, $R_S = 50\ \Omega$,	$V_{IC} = 0$, $R_L = 10\text{ k}\Omega$	25°C	0.9		5
					Full range			7
			$V_O = 1.4\text{ V}$, $R_S = 50\ \Omega$,	$V_{IC} = 0$, $R_L = 10\text{ k}\Omega$	25°C	230	2000	μV
					Full range		3500	
α_{VIO}	Temperature coefficient of input offset voltage		25°C to 85°C	1.8		$\mu\text{V}/^\circ\text{C}$		
I_{IO}	Input offset current (see Note 4)	$V_O = 2.5\text{ V}$,	$V_{IC} = 2.5\text{ V}$	25°C	0.1		pA	
				85°C	24	15		
I_{IB}	Input bias current (see Note 4)	$V_O = 2.5\text{ V}$,	$V_{IC} = 2.5\text{ V}$	25°C	0.6		pA	
				85°C	200	35		
V_{ICR}	Common-mode input voltage range (see Note 5)			25°C	-0.2 to 4	-0.3 to 4.2	V	
				Full range	-0.2 to 3.5		V	
V_{OH}	High-level output voltage	$V_{ID} = 100\text{ mV}$,	$R_L = 10\text{ k}\Omega$	25°C	3.2	3.8	V	
				-40°C	3	3.8		
				85°C	3	3.8		
V_{OL}	Low-level output voltage	$V_{ID} = -100\text{ mV}$,	$I_{OL} = 0$	25°C	0	50	mV	
				-40°C	0	50		
				85°C	0	50		
A_{VD}	Large-signal differential voltage amplification	$V_O = 1\text{ V to }6\text{ V}$,	$R_L = 10\text{ k}\Omega$	25°C	5	23	V/mV	
				-40°C	3.5	32		
				85°C	3.5	19		
CMRR	Common-mode rejection ratio	$V_{IC} = V_{ICRmin}$		25°C	65	80	dB	
				-40°C	60	81		
				85°C	60	86		
k_{SVR}	Supply-voltage rejection ratio ($\Delta V_{DD}/\Delta V_{IO}$)	$V_{DD} = 5\text{ V to }10\text{ V}$,	$V_O = 1.4\text{ V}$	25°C	65	95	dB	
				-40°C	60	92		
				85°C	60	96		
I_{DD}	Supply current (two amplifiers)	$V_O = 5\text{ V}$, No load	$V_{IC} = 5\text{ V}$,	25°C	1.4	3.2	mA	
				-40°C	1.9	4.4		
				85°C	1.1	2.4		

† Full range is -40°C to 85°C.

NOTES: 4. The typical values of input bias current and input offset current below 5 pA were determined mathematically.

5. This range also applies to each input individually.

XD272 DIP8 / XL272 SOP8

electrical characteristics at specified free-air temperature, $V_{DD} = 10\text{ V}$ (unless otherwise noted)

PARAMETER		TEST CONDITIONS		T_A †	XD272 DIP8 XL272 SOP8			UNIT		
					MIN	TYP	MAX			
V_{IO}	Input offset voltage	272	$V_O = 1.4\text{ V}$, $R_S = 50\ \Omega$	$V_{IC} = 0$, $R_L = 10\text{ k}\Omega$	25°C	1.1	10	mV		
				Full range			13			
			$V_{IC} = 0$, $R_L = 10\text{ k}\Omega$	25°C	0.9	5				
					Full range			7		
					$V_O = 1.4\text{ V}$, $R_S = 50\ \Omega$	$V_{IC} = 0$, $R_L = 10\text{ k}\Omega$	25°C	290	2000	μV
					Full range			3500		
α_{VIO}	Temperature coefficient of input offset voltage				25°C to 85°C	2		$\mu\text{V}/^\circ\text{C}$		
I_{IO}	Input offset current (see Note 4)		$V_O = 5\text{ V}$,	$V_{IC} = 5\text{ V}$	25°C	0.1		pA		
					85°C	26	1000			
I_{IB}	Input bias current (see Note 4)		$V_O = 5\text{ V}$,	$V_{IC} = 5\text{ V}$	25°C	0.7		pA		
					85°C	220	2000			
V_{ICR}	Common-mode input voltage range (see Note 5)				25°C	-0.2 to 9	-0.3 to 9.2	V		
					Full range	-0.2 to 8.5		V		
V_{OH}	High-level output voltage		$V_{ID} = 100\text{ mV}$,	$R_L = 10\text{ k}\Omega$	25°C	8	8.5	V		
					-40°C	7.8	8.5			
					85°C	7.8	8.5			
V_{OL}	Low-level output voltage		$V_{ID} = -100\text{ mV}$,	$I_{OL} = 0$	25°C	0	50	mV		
					-40°C	0	50			
					85°C	0	50			
A_{VD}	Large-signal differential voltage amplification		$V_O = 1\text{ V to }6\text{ V}$,	$R_L = 10\text{ k}\Omega$	25°C	10	36	V/mV		
					-40°C	7	46			
					85°C	7	31			
CMRR	Common-mode rejection ratio		$V_{IC} = V_{ICRmin}$		25°C	65	85	dB		
					-40°C	60	87			
					85°C	60	88			
k_{SVR}	Supply-voltage rejection ratio ($\Delta V_{DD}/\Delta V_{IO}$)		$V_{DD} = 5\text{ V to }10\text{ V}$,	$V_O = 1.4\text{ V}$	25°C	65	95	dB		
					-40°C	60	92			
					85°C	60	96			
I_{DD}	Supply current (two amplifiers)		$V_O = 5\text{ V}$, No load	$V_{IC} = 5\text{ V}$,	25°C	1.4	4	mA		
					-40°C	2.8	5			
					85°C	1.5	3.2			

† Full range is -40°C to 85°C.

NOTES: 4. The typical values of input bias current and input offset current below 5 pA were determined mathematically.

5. This range also applies to each input individually.

XD272 DIP8 / XL272 SOP8

electrical characteristics at specified free-air temperature, $V_{DD} = 5\text{ V}$ (unless otherwise noted)

PARAMETER		TEST CONDITIONS		T_A †	XD272 DIP8/XL272 SOP8			UNIT
					MIN	TYP	MAX	
V_{IO}	Input offset voltage	272	$V_O = 1.4\text{ V}$, $R_S = 50\ \Omega$,	$V_{IC} = 0$, $R_L = 10\text{ k}\Omega$	25°C	1.1	10	mV
					Full range		12	
α_{VIO}	Temperature coefficient of input offset voltage			25°C to 125°C	2.1		$\mu\text{V}/^\circ\text{C}$	
I_{IO}	Input offset current (see Note 4)	$V_O = 2.5\text{ V}$	$V_{IC} = 2.5\text{ V}$	25°C	0.1		pA	
				125°C	1.4	15	nA	
I_{IB}	Input bias current (see Note 4)	$V_O = 2.5\text{ V}$	$V_{IC} = 2.5\text{ V}$	25°C	0.6		pA	
				125°C	9	35	nA	
V_{ICR}	Common-mode input voltage range (see Note 5)			25°C	0 to 4	-0.3 to 4.2	V	
				Full range	0 to 3.5		V	
V_{OH}	High-level output voltage	$V_{ID} = 100\text{ mV}$,	$R_L = 10\text{ k}\Omega$	25°C	3.2	3.8	V	
				-55°C	3	3.8		
				125°C	3	3.8		
V_{OL}	Low-level output voltage	$V_{ID} = -100\text{ mV}$,	$I_{OL} = 0$	25°C	0	50	mV	
				-55°C	0	50		
				125°C	0	50		
A_{VD}	Large-signal differential voltage amplification	$V_O = 0.25\text{ V to }2\text{ V}$	$R_L = 10\text{ k}\Omega$	25°C	5	23	V/mV	
				-55°C	3.5	35		
				125°C	3.5	16		
CMRR	Common-mode rejection ratio	$V_{IC} = V_{ICRmin}$		25°C	65	80	dB	
				-55°C	60	81		
				125°C	60	84		
k_{SVR}	Supply-voltage rejection ratio ($\Delta V_{DD}/\Delta V_{IO}$)	$V_{DD} = 5\text{ V to }10\text{ V}$,	$V_O = 1.4\text{ V}$	25°C	65	95	dB	
				-55°C	60	90		
				125°C	60	97		
I_{DD}	Supply current (two amplifiers)	$V_O = 2.5\text{ V}$, No load	$V_{IC} = 2.5\text{ V}$,	25°C	1.4	3.2	mA	
				-55°C	2	5		
				125°C	1	2.2		

† Full range is -55°C to 125°C.

- NOTES: 4. The typical values of input bias current and input offset current below 5 pA were determined mathematically.
5. This range also applies to each input individually.

XD272 DIP8 / XL272 SOP8

electrical characteristics at specified free-air temperature, $V_{DD} = 10\text{ V}$ (unless otherwise noted)

PARAMETER		TEST CONDITIONS		T_A^\dagger	XD272 DIP8/XL272 SOP8			UNIT
					MIN	TYP	MAX	
V_{IO}	Input offset voltage	272	$V_O = 1.4\text{ V}$, $R_S = 50\ \Omega$,	$V_{IC} = 0$, $R_L = 10\text{ k}\Omega$	25°C	1.1	10	mV
					Full range		12	
α_{VIO}	Temperature coefficient of input offset voltage			25°C to 125°C		2.2	$\mu\text{V}/^\circ\text{C}$	
I_{IO}	Input offset current (see Note 4)		$V_O = 5\text{ V}$,	$V_{IC} = 5\text{ V}$	25°C	0.1		pA
					125°C	1.8	15	nA
I_{IB}	Input bias current (see Note 4)		$V_O = 5\text{ V}$,	$V_{IC} = 5\text{ V}$	25°C	0.7		pA
					125°C	10	35	nA
V_{ICR}	Common-mode input voltage range (see Note 5)				25°C	0 to 9	-0.3 to 9.2	V
					Full range	0 to 8.5		V
V_{OH}	High-level output voltage		$V_{ID} = 100\text{ mV}$,	$R_L = 10\text{ k}\Omega$	25°C	8	8.5	V
					-55°C	7.8	8.5	
					125°C	7.8	8.4	
V_{OL}	Low-level output voltage		$V_{ID} = -100\text{ mV}$,	$I_{OL} = 0$	25°C	0	50	mV
					-55°C	0	50	
					125°C	0	50	
A_{VD}	Large-signal differential voltage amplification		$V_O = 1\text{ V to }6\text{ V}$,	$R_L = 10\text{ k}\Omega$	25°C	10	36	V/mV
					-55°C	7	50	
					125°C	7	27	
CMRR	Common-mode rejection ratio		$V_{IC} = V_{ICRmin}$		25°C	65	85	dB
					-55°C	60	87	
					125°C	60	86	
k_{SVR}	Supply-voltage rejection ratio ($\Delta V_{DD}/\Delta V_{IO}$)		$V_{DD} = 5\text{ V to }10\text{ V}$,	$V_O = 1.4\text{ V}$	25°C	65	95	dB
					-55°C	60	90	
					125°C	60	97	
I_{DD}	Supply current (two amplifiers)		$V_O = 5\text{ V}$, No load	$V_{IC} = 5\text{ V}$,	25°C	1.9	4	mA
					-55°C	3	6	
					125°C	1.3	2.8	

† Full range is -55°C to 125°C.

NOTES: 4. The typical values of input bias current and input offset current below 5 pA were determined mathematically.

5. This range also applies to each input individually.

XD272 DIP8 / XL272 SOP8

electrical characteristics, $V_{DD} = 5\text{ V}$, $T_A = 25^\circ\text{C}$ (unless otherwise noted)

PARAMETER	TEST CONDITIONS	XD272 DIP8/XL272 SOP8			UNIT
		MIN	TYP	MAX	
V_{IO} Input offset voltage	$V_O = 1.4\text{ V}$, $R_S = 50\ \Omega$, $V_{IC} = 0$, $R_L = 10\text{ k}\Omega$		1.1	10	mV
$\alpha_{V_{IO}}$ Temperature coefficient of input offset voltage			1.8		$\mu\text{V}/^\circ\text{C}$
I_{IO} Input offset current (see Note 4)	$V_O = 2.5\text{ V}$, $V_{IC} = 2.5\text{ V}$		0.1		pA
I_{IB} Input bias current (see Note 4)	$V_O = 2.5\text{ V}$, $V_{IC} = 2.5\text{ V}$		0.6		pA
V_{ICR} Common-mode input voltage range (see Note 5)		-0.2 to 4	-0.3 to 4.2		V
V_{OH} High-level output voltage	$V_{ID} = 100\text{ mV}$, $R_L = 10\text{ k}\Omega$	3.2	3.8		V
V_{OL} Low-level output voltage	$V_{ID} = -100\text{ mV}$, $I_{OL} = 0$		0	50	mV
A_{VD} Large-signal differential voltage amplification	$V_O = 0.25\text{ V to }2\text{ V}$, $R_L = 10\text{ k}\Omega$	5	23		V/mV
CMRR Common-mode rejection ratio	$V_{IC} = V_{ICRmin}$	65	80		dB
k_{SVR} Supply-voltage rejection ratio ($\Delta V_{DD}/\Delta V_{IO}$)	$V_{DD} = 5\text{ V to }10\text{ V}$, $V_O = 1.4\text{ V}$	65	95		dB
I_{DD} Supply current (two amplifiers)	$V_O = 2.5\text{ V}$, No load $V_{IC} = 2.5\text{ V}$		1.4	3.2	mA

NOTES: 4. The typical values of input bias current and input offset current below 5 pA were determined mathematically.
5. This range also applies to each input individually.

electrical characteristics, $V_{DD} = 10\text{ V}$, $T_A = 25^\circ\text{C}$ (unless otherwise noted)

PARAMETER	TEST CONDITIONS	XD272 DIP8/XL272 SOP8			UNIT
		MIN	TYP	MAX	
V_{IO} Input offset voltage	$V_O = 1.4\text{ V}$, $R_S = 50\ \Omega$, $V_{IC} = 0$, $R_L = 10\text{ k}\Omega$		1.1	10	mV
$\alpha_{V_{IO}}$ Temperature coefficient of input offset voltage			1.8		$\mu\text{V}/^\circ\text{C}$
I_{IO} Input offset current (see Note 4)	$V_O = 5\text{ V}$, $V_{IC} = 5\text{ V}$		0.1		pA
I_{IB} Input bias current (see Note 4)	$V_O = 5\text{ V}$, $V_{IC} = 5\text{ V}$		0.7		pA
V_{ICR} Common-mode input voltage range (see Note 5)		-0.2 to 9	-0.3 to 9.2		V
V_{OH} High-level output voltage	$V_{ID} = 100\text{ mV}$, $R_L = 10\text{ k}\Omega$	8	8.5		V
V_{OL} Low-level output voltage	$V_{ID} = -100\text{ mV}$, $I_{OL} = 0$		0	50	mV
A_{VD} Large-signal differential voltage amplification	$V_O = 1\text{ V to }6\text{ V}$, $R_L = 10\text{ k}\Omega$	10	36		V/mV
CMRR Common-mode rejection ratio	$V_{IC} = V_{ICRmin}$	65	85		dB
k_{SVR} Supply-voltage rejection ratio ($\Delta V_{DD}/\Delta V_{IO}$)	$V_{DD} = 5\text{ V to }10\text{ V}$, $V_O = 1.4\text{ V}$	65	95		dB
I_{DD} Supply current (two amplifiers)	$V_O = 5\text{ V}$, No load $V_{IC} = 5\text{ V}$		1.9	4	mA

NOTES: 4. The typical values of input bias current and input offset current below 5 pA were determined mathematically.
5. This range also applies to each input individually.

XD272 DIP8 / XL272 SOP8

operating characteristics at specified free-air temperature, $V_{DD} = 5\text{ V}$

PARAMETER	TEST CONDITIONS		XD272 DIP8 XL272 SOP8			UNIT
			MIN	TYP	MAX	
SR Slew rate at unity gain	$R_L = 10\text{ k}\Omega$, $C_L = 20\text{ pF}$, See Figure 1	$V_{I\text{PP}} = 1\text{ V}$	25°C	3.6		V/ μs
			0°C	4		
			70°C	3		
		$V_{I\text{PP}} = 2.5\text{ V}$	25°C	2.9		
			0°C	3.1		
			70°C	2.5		
V_n Equivalent input noise voltage	$f = 1\text{ kHz}$, See Figure 2	$R_S = 20\ \Omega$, 25°C	25		nV/ $\sqrt{\text{Hz}}$	
B_{OM} Maximum output-swing bandwidth	$V_O = V_{\text{OH}}$, $R_L = 10\text{ k}\Omega$, See Figure 1	$C_L = 20\text{ pF}$, See Figure 1	25°C	320		kHz
			0°C	340		
			70°C	260		
B_1 Unity-gain bandwidth	$V_I = 10\text{ mV}$, See Figure 3	$C_L = 20\text{ pF}$,	25°C	1.7		MHz
			0°C	2		
			70°C	1.3		
ϕ_m Phase margin	$V_I = 10\text{ mV}$, $C_L = 20\text{ pF}$,	$f = B_1$, See Figure 3	25°C	46°		
			0°C	47°		
			70°C	43°		

operating characteristics at specified free-air temperature, $V_{DD} = 10\text{ V}$

PARAMETER	TEST CONDITIONS	T_A	XD272 DIP8 XL272 SOP8			UNIT
			MIN	TYP	MAX	
SR Slew rate at unity gain	$R_L = 10\text{ k}\Omega$, $C_L = 20\text{ pF}$, See Figure 1	$V_{I\text{PP}} = 1\text{ V}$	25°C	5.3		V/ μs
			0°C	5.9		
			70°C	4.3		
		$V_{I\text{PP}} = 5.5\text{ V}$	25°C	4.6		
			0°C	5.1		
			70°C	3.8		
V_n Equivalent input noise voltage	$f = 1\text{ kHz}$, See Figure 2	$R_S = 20\ \Omega$, 25°C	25		nV/ $\sqrt{\text{Hz}}$	
B_{OM} Maximum output-swing bandwidth	$V_O = V_{\text{OH}}$, $R_L = 10\text{ k}\Omega$, See Figure 1	$C_L = 20\text{ pF}$, See Figure 1	25°C	200		kHz
			0°C	220		
			70°C	140		
B_1 Unity-gain bandwidth	$V_I = 10\text{ mV}$, See Figure 3	$C_L = 20\text{ pF}$,	25°C	2.2		MHz
			0°C	2.5		
			70°C	1.8		
ϕ_m Phase margin	$V_I = 10\text{ mV}$, $C_L = 20\text{ pF}$,	$f = B_1$, See Figure 3	25°C	49°		
			0°C	50°		
			70°C	46°		

XD272 DIP8 / XL272 SOP8

operating characteristics at specified free-air temperature, $V_{DD} = 5\text{ V}$

PARAMETER	TEST CONDITIONS		T_A	XD272 DIP8 XL272 SOP8			UNIT
				MIN	TYP	MAX	
SR Slew rate at unity gain	$R_L = 10\text{ k}\Omega$, $C_L = 20\text{ pF}$, See Figure 1	$V_{I\text{PP}} = 1\text{ V}$	25°C	3.6		V/ μs	
			-40°C	4.5			
			85°C	2.8			
		$V_{I\text{PP}} = 2.5\text{ V}$	25°C	2.9			
			-40°C	3.5			
			85°C	2.3			
V_n Equivalent input noise voltage	$f = 1\text{ kHz}$, See Figure 2	$R_S = 20\ \Omega$,	25°C	25		nV/ $\sqrt{\text{Hz}}$	
B_{OM} Maximum output-swing bandwidth	$V_O = V_{\text{OH}}$, $R_L = 10\text{ k}\Omega$,	$C_L = 20\text{ pF}$, See Figure 1	25°C	320		kHz	
			-40°C	380			
			85°C	250			
B_1 Unity-gain bandwidth	$V_I = 10\text{ mV}$, See Figure 3	$C_L = 20\text{ pF}$,	25°C	1.7		MHz	
			-40°C	2.6			
			85°C	1.2			
ϕ_m Phase margin	$V_I = 10\text{ mV}$, $C_L = 20\text{ pF}$,	$f = B_1$, See Figure 3	25°C	46°			
			-40°C	49°			
			85°C	43°			

operating characteristics at specified free-air temperature, $V_{DD} = 10\text{ V}$

PARAMETER	TEST CONDITIONS		T_A	XD272 DIP8 XL272 SOP8			UNIT
				MIN	TYP	MAX	
SR Slew rate at unity gain	$R_L = 10\text{ k}\Omega$, $C_L = 20\text{ pF}$, See Figure 1	$V_{I\text{PP}} = 1\text{ V}$	25°C	5.3		V/ μs	
			-40°C	6.8			
			85°C	4			
		$V_{I\text{PP}} = 5.5\text{ V}$	25°C	4.6			
			-40°C	5.8			
			85°C	3.5			
V_n Equivalent input noise voltage	$f = 1\text{ kHz}$, See Figure 2	$R_S = 20\ \Omega$,	25°C	25		nV/ $\sqrt{\text{Hz}}$	
B_{OM} Maximum output-swing bandwidth	$V_O = V_{\text{OH}}$, $R_L = 10\text{ k}\Omega$,	$C_L = 20\text{ pF}$, See Figure 1	25°C	200		kHz	
			-40°C	260			
			85°C	130			
B_1 Unity-gain bandwidth	$V_I = 10\text{ mV}$, See Figure 3	$C_L = 20\text{ pF}$,	25°C	2.2		MHz	
			-40°C	3.1			
			85°C	1.7			
ϕ_m Phase margin	$V_I = 10\text{ mV}$, $C_L = 20\text{ pF}$,	$f = B_1$, See Figure 3	25°C	49°			
			-40°C	52°			
			85°C	46°			

XD272 DIP8 / XL272 SOP8

operating characteristics at specified free-air temperature, $V_{DD} = 5\text{ V}$

PARAMETER	TEST CONDITIONS	T_A	XD272 DIP8 XL272 SOP8			UNIT
			MIN	TYP	MAX	
SR Slew rate at unity gain	$R_L = 10\text{ k}\Omega$, $C_L = 20\text{ pF}$, See Figure 1	$V_{I\text{PP}} = 1\text{ V}$	25°C	3.6		V/ μs
			-55°C	4.7		
			125°C	2.3		
		$V_{I\text{PP}} = 2.5\text{ V}$	25°C	2.9		
			-55°C	3.7		
			125°C	2		
V_n Equivalent input noise voltage	$f = 1\text{ kHz}$, See Figure 2	$R_S = 20\ \Omega$	25°C	25		nV/ $\sqrt{\text{Hz}}$
BOM Maximum output-swing bandwidth	$V_O = V_{OH}$, $R_L = 10\text{ k}\Omega$, See Figure 1	$C_L = 20\text{ pF}$, See Figure 1	25°C	320		kHz
			-55°C	400		
			125°C	230		
B ₁ Unity-gain bandwidth	$V_I = 10\text{ mV}$, See Figure 3	$C_L = 20\text{ pF}$	25°C	1.7		MHz
			-55°C	2.9		
			125°C	1.1		
ϕ_m Phase margin	$V_I = 10\text{ mV}$, $C_L = 20\text{ pF}$,	$f = B_1$, See Figure 3	25°C	46°		
			-55°C	49°		
			125°C	41°		

operating characteristics at specified free-air temperature, $V_{DD} = 10\text{ V}$

PARAMETER	TEST CONDITIONS	T_A	XD272 DIP8 XL272 SOP8			UNIT
			MIN	TYP	MAX	
SR Slew rate at unity gain	$R_L = 10\text{ k}\Omega$, $C_L = 20\text{ pF}$, See Figure 1	$V_{I\text{PP}} = 1\text{ V}$	25°C	5.3		V/ μs
			-55°C	7.1		
			125°C	3.1		
		$V_{I\text{PP}} = 5.5\text{ V}$	25°C	4.6		
			-55°C	6.1		
			125°C	2.7		
V_n Equivalent input noise voltage	$f = 1\text{ kHz}$, See Figure 2	$R_S = 20\ \Omega$	25°C	25		nV/ $\sqrt{\text{Hz}}$
BOM Maximum output-swing bandwidth	$V_O = V_{OH}$, $R_L = 10\text{ k}\Omega$, See Figure 1	$C_L = 20\text{ pF}$, See Figure 1	25°C	200		kHz
			-55°C	280		
			125°C	110		
B ₁ Unity-gain bandwidth	$V_I = 10\text{ mV}$, See Figure 3	$C_L = 20\text{ pF}$	25°C	2.2		MHz
			-55°C	3.4		
			125°C	1.6		
ϕ_m Phase margin	$V_I = 10\text{ mV}$, $C_L = 20\text{ pF}$,	$f = B_1$, See Figure 3	25°C	49°		
			-55°C	52°		
			125°C	44°		

XD272 DIP8 / XL272 SOP8

operating characteristics, $V_{DD} = 5\text{ V}$, $T_A = 25^\circ\text{C}$

PARAMETER		TEST CONDITIONS			272			UNIT
					MIN	TYP	MAX	
SR	Slew rate at unity gain	$R_L = 10\text{ k}\Omega$, See Figure 1	$C_L = 20\text{ pF}$,	$V_{I\text{PP}} = 1\text{ V}$	3.6			$\text{V}/\mu\text{s}$
				$V_{I\text{PP}} = 2.5\text{ V}$	2.9			
V_n	Equivalent input noise voltage	$f = 1\text{ kHz}$,	$R_S = 20\ \Omega$,	See Figure 2	25			$\text{nV}/\sqrt{\text{Hz}}$
B_{OM}	Maximum output-swing bandwidth	$V_O = V_{\text{OH}}$, See Figure 1	$C_L = 20\text{ pF}$,	$R_L = 10\text{ k}\Omega$,	320			kHz
B_1	Unity-gain bandwidth	$V_I = 10\text{ mV}$,	$C_L = 20\text{ pF}$,	See Figure 3	1.7			MHz
ϕ_m	Phase margin	$V_I = 10\text{ mV}$, See Figure 3	$f = B_1$,	$C_L = 20\text{ pF}$,	46°			

operating characteristics, $V_{DD} = 10\text{ V}$, $T_A = 25^\circ\text{C}$

PARAMETER		TEST CONDITIONS			272			UNIT
					MIN	TYP	MAX	
SR	Slew rate at unity gain	$R_L = 10\text{ k}\Omega$, See Figure 1	$C_L = 20\text{ pF}$,	$V_{I\text{PP}} = 1\text{ V}$	5.3			$\text{V}/\mu\text{s}$
				$V_{I\text{PP}} = 5.5\text{ V}$	4.6			
V_n	Equivalent input noise voltage	$f = 1\text{ kHz}$,	$R_S = 20\ \Omega$,	See Figure 2	25			$\text{nV}/\sqrt{\text{Hz}}$
B_{OM}	Maximum output-swing bandwidth	$V_O = V_{\text{OH}}$, See Figure 1	$C_L = 20\text{ pF}$,	$R_L = 10\text{ k}\Omega$,	200			kHz
B_1	Unity-gain bandwidth	$V_I = 10\text{ mV}$,	$C_L = 20\text{ pF}$,	See Figure 3	2.2			MHz
ϕ_m	Phase margin	$V_I = 10\text{ mV}$, See Figure 3	$f = B_1$,	$C_L = 20\text{ pF}$,	49°			

PARAMETER MEASUREMENT INFORMATION

single-supply versus split-supply test circuits

Because the 272 are optimized for single-supply operation, circuit configurations used for the various tests often present some inconvenience since the input signal, in many cases, must be offset from ground. This inconvenience can be avoided by testing the device with split supplies and the output load tied to the negative rail. A comparison of single-supply versus split-supply test circuits is shown below. The use of either circuit gives the same result.

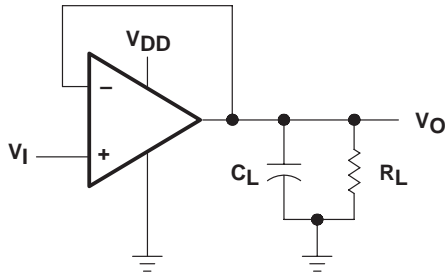

(a) SINGLE SUPPLY

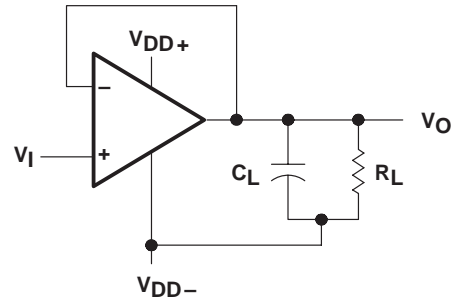

(b) SPLIT SUPPLY

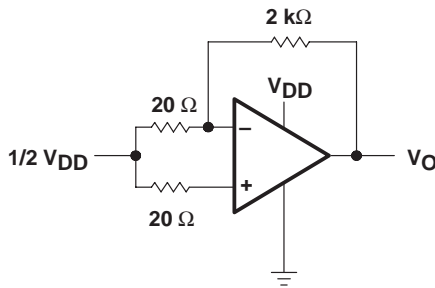

(a) SINGLE SUPPLY

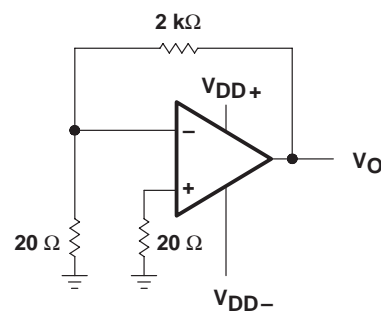

(b) SPLIT SUPPLY

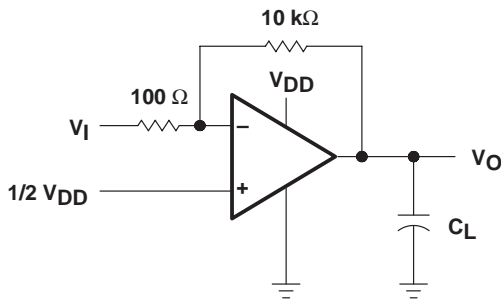

(a) SINGLE SUPPLY

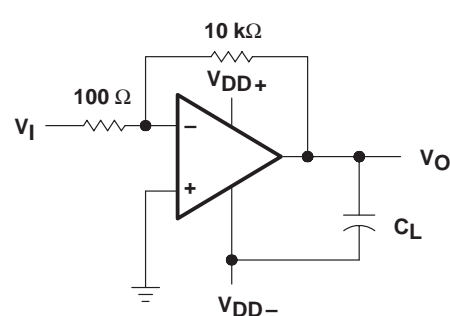

(b) SPLIT SUPPLY

XD272 DIP8 / XL272 SOP8

TYPICAL CHARACTERISTICS†

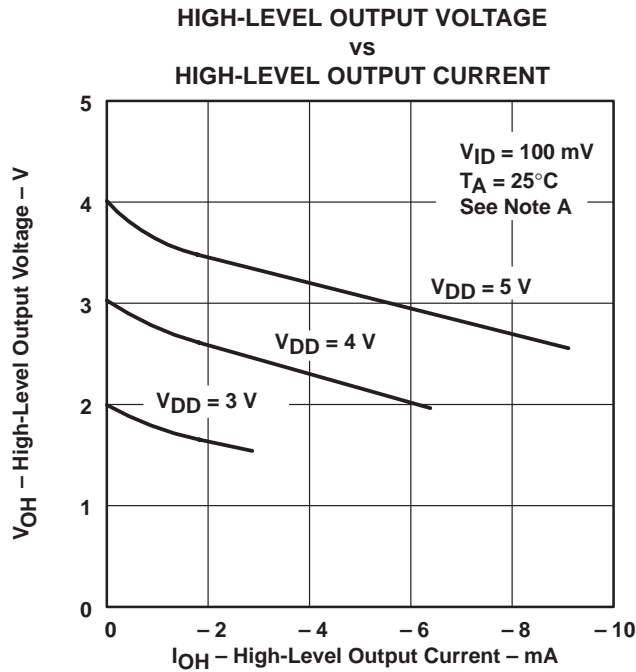

NOTE A: The 3-V curve only applies to the C version.

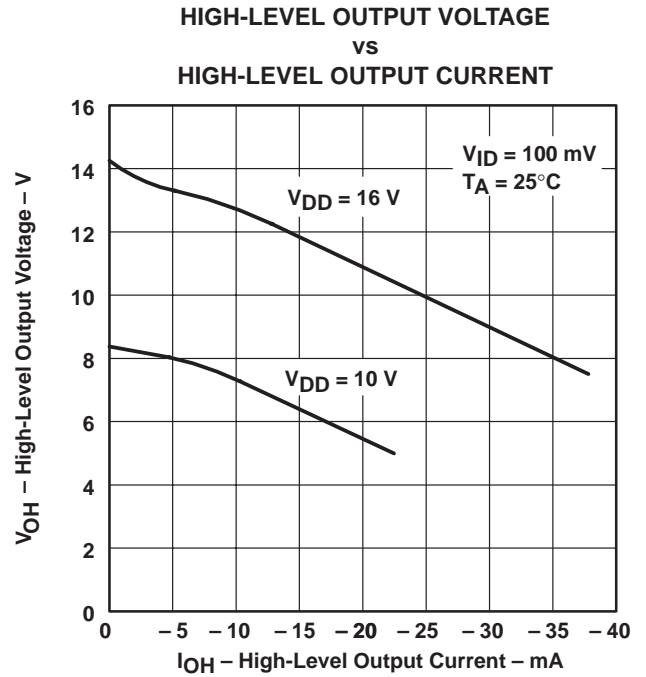

**HIGH-LEVEL OUTPUT VOLTAGE
vs
SUPPLY VOLTAGE**

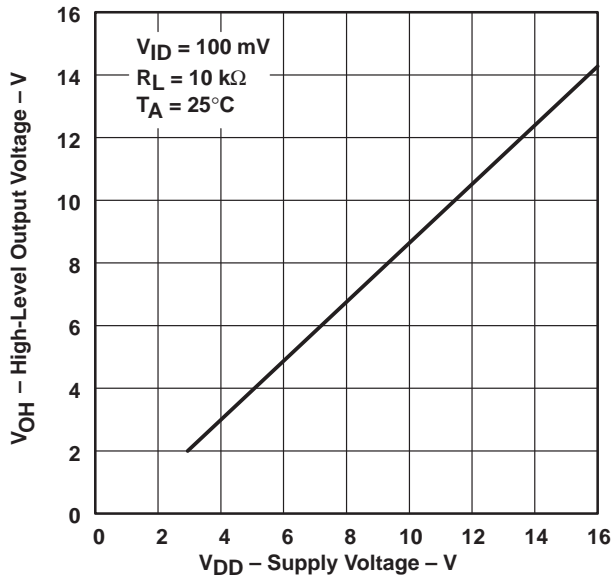

**HIGH-LEVEL OUTPUT VOLTAGE
vs
FREE-AIR TEMPERATURE**

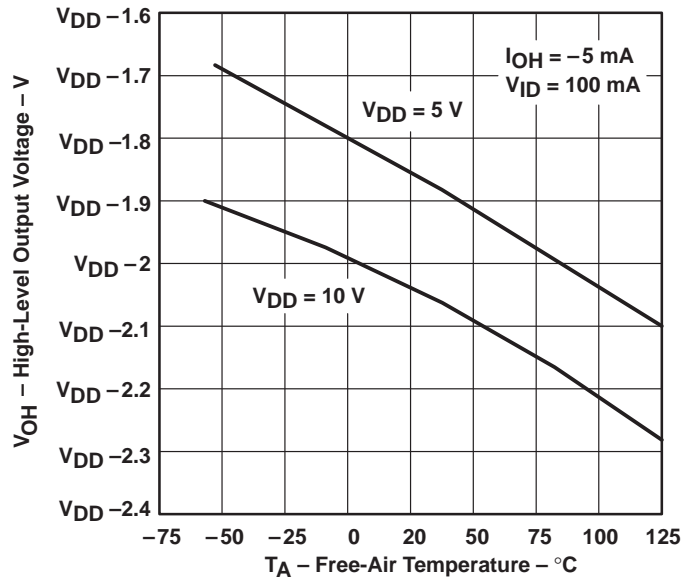

† Data at high and low temperatures are applicable only within the rated operating free-air temperature ranges of the various devices.

TYPICAL CHARACTERISTICS†

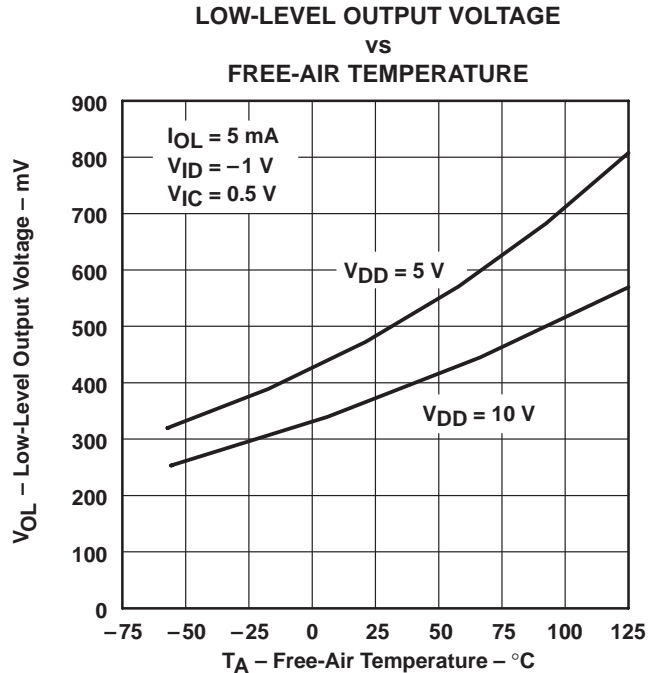
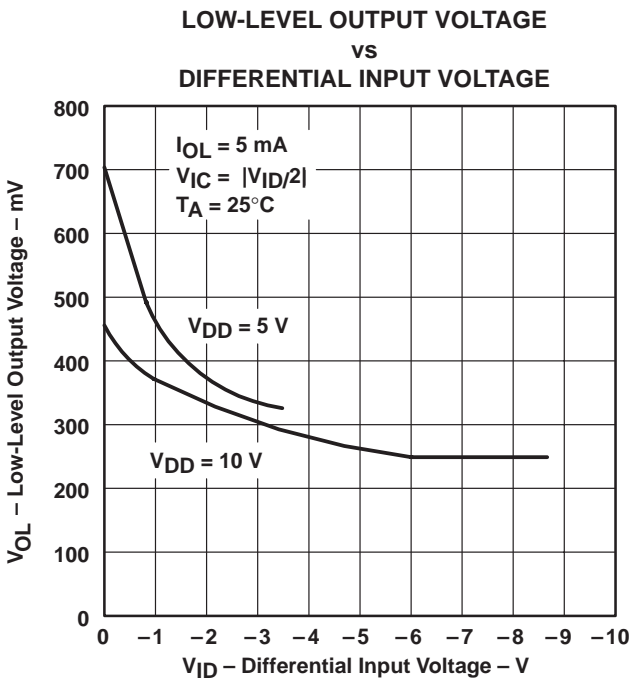
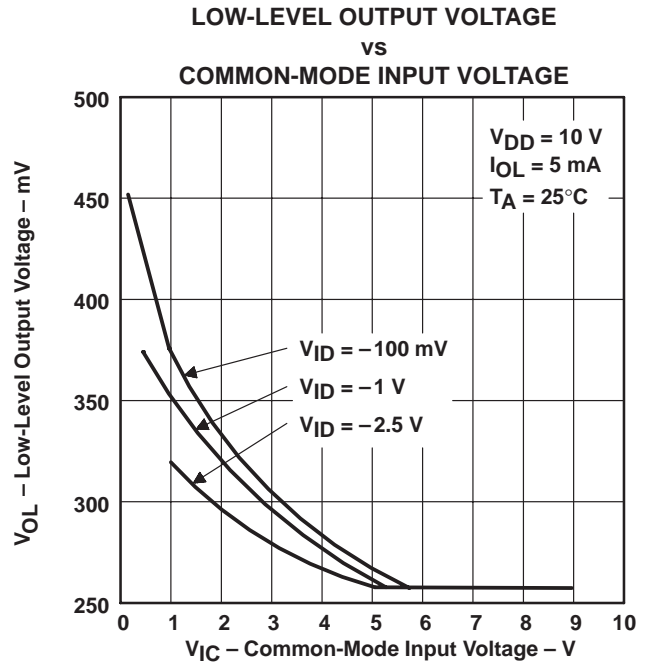
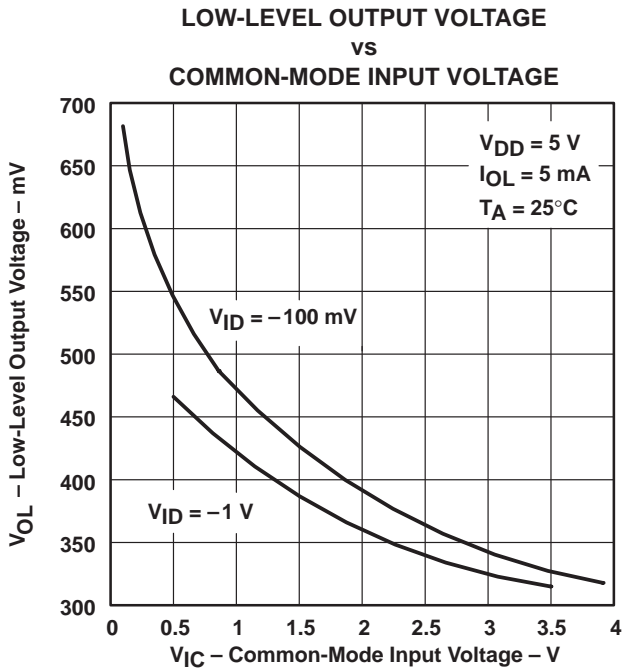

† Data at high and low temperatures are applicable only within the rated operating free-air temperature ranges of the various devices.

XD272 DIP8 / XL272 SOP8

TYPICAL CHARACTERISTICS†

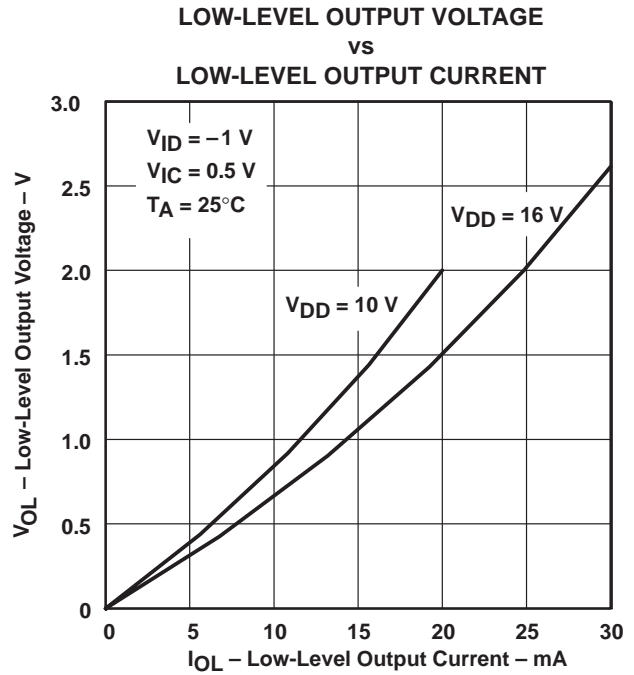
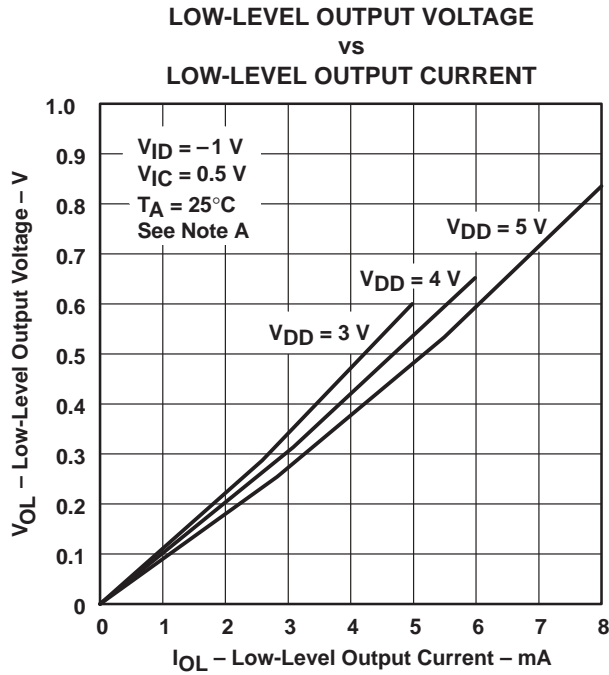

NOTE A: The 3-V curve only applies to the C version.

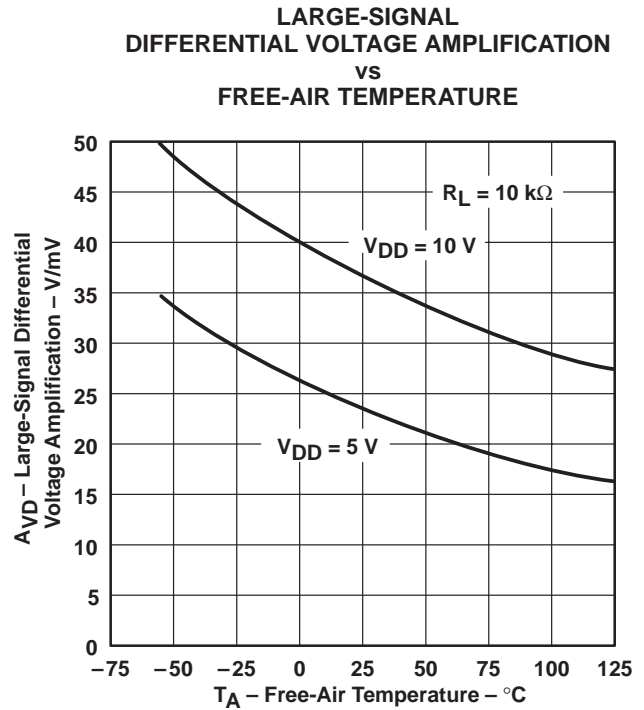
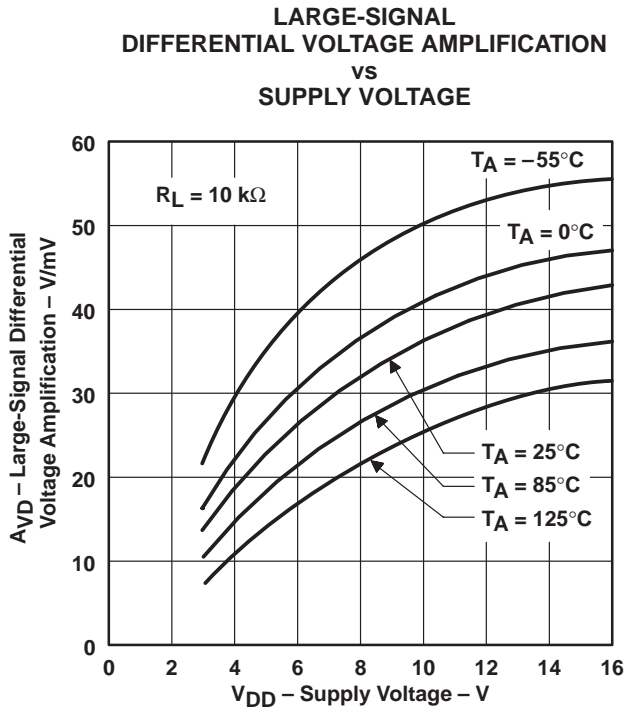

† Data at high and low temperatures are applicable only within the rated operating free-air temperature ranges of the various devices.

TYPICAL CHARACTERISTICS†

INPUT BIAS CURRENT AND INPUT OFFSET CURRENT[†]
vs
FREE-AIR TEMPERATURE

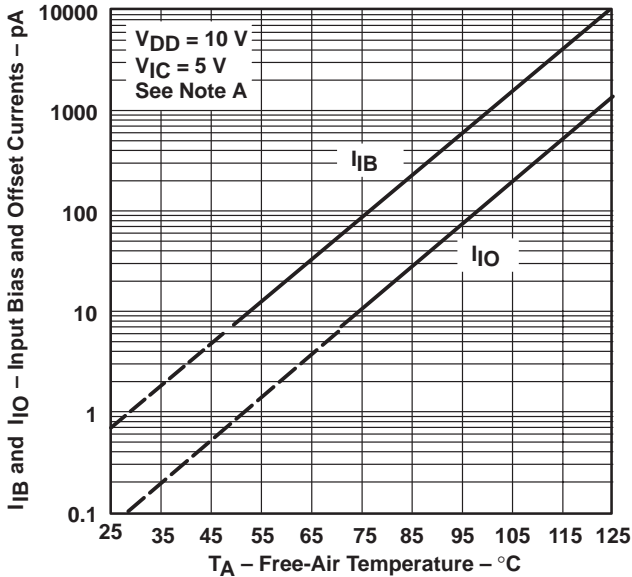

NOTE A: The typical values of input bias current and input offset current below 5 pA were determined mathematically.

COMMON-MODE INPUT VOLTAGE POSITIVE LIMIT
vs
SUPPLY VOLTAGE

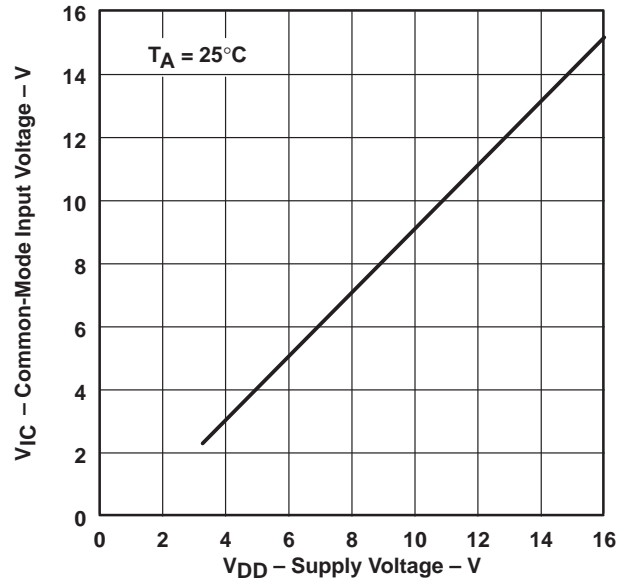

SUPPLY CURRENT
vs
SUPPLY VOLTAGE

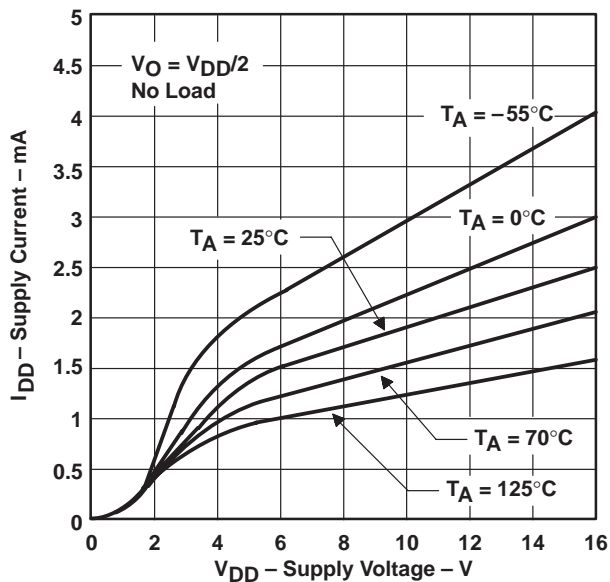

SUPPLY CURRENT
vs
FREE-AIR TEMPERATURE

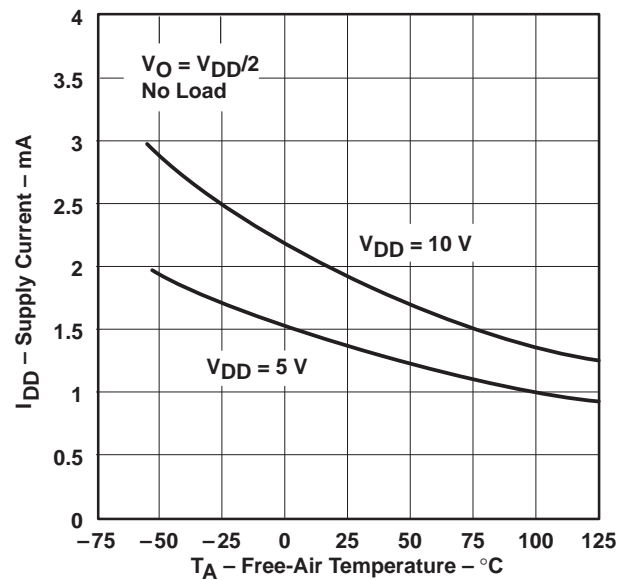

† Data at high and low temperatures are applicable only within the rated operating free-air temperature ranges of the various devices.

XD272 DIP8 / XL272 SOP8

TYPICAL CHARACTERISTICS†

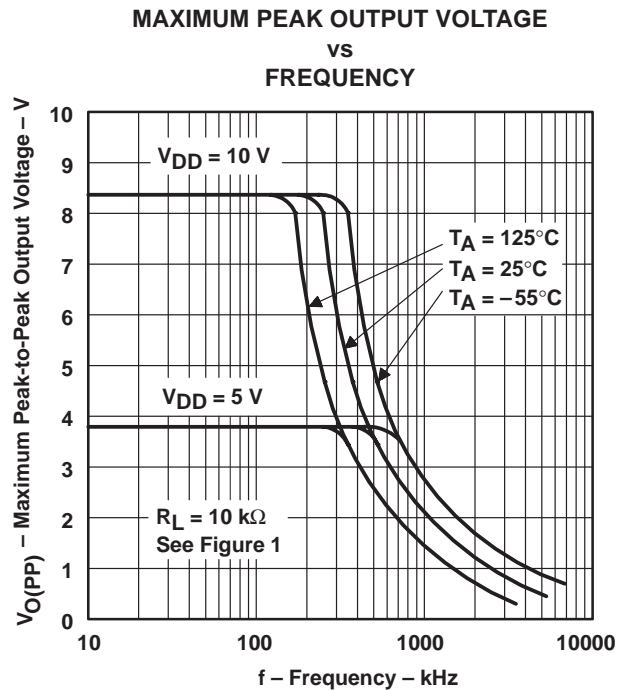
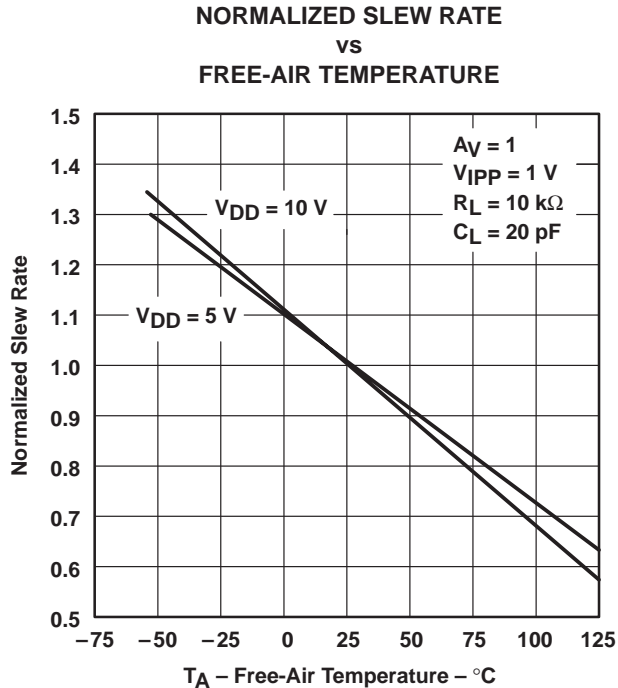
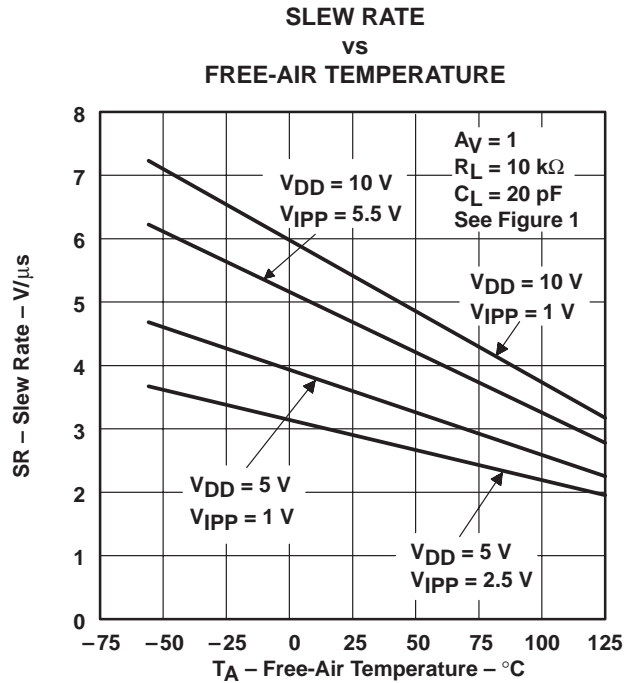
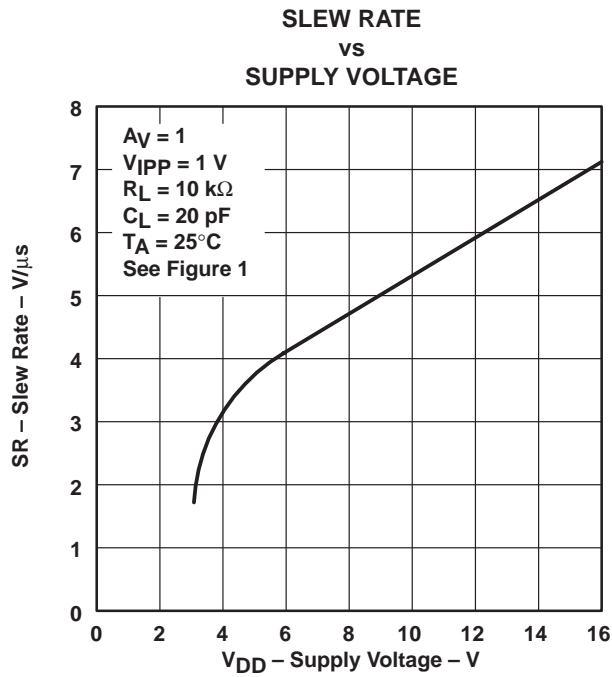

† Data at high and low temperatures are applicable only within the rated operating free-air temperature ranges of the various devices.

XD272 DIP8 / XL272 SOP8

TYPICAL CHARACTERISTICS†

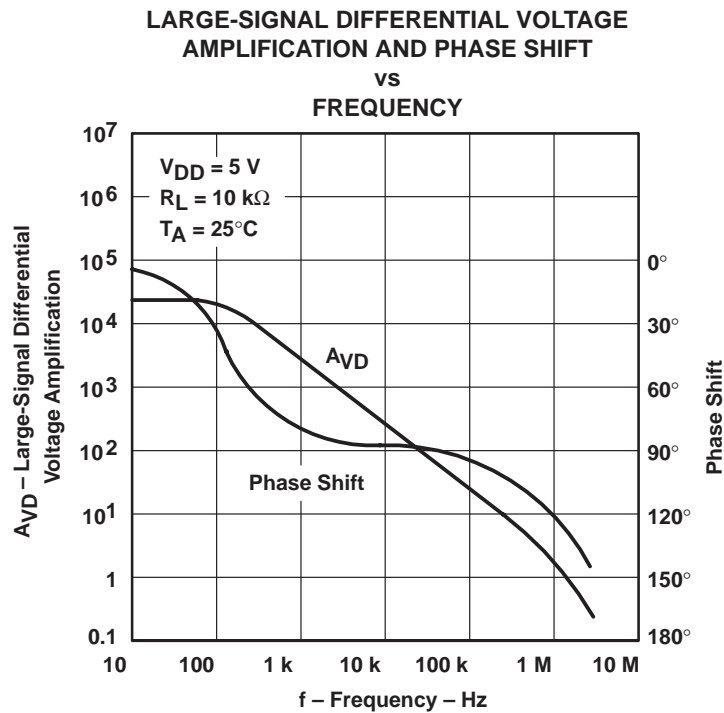
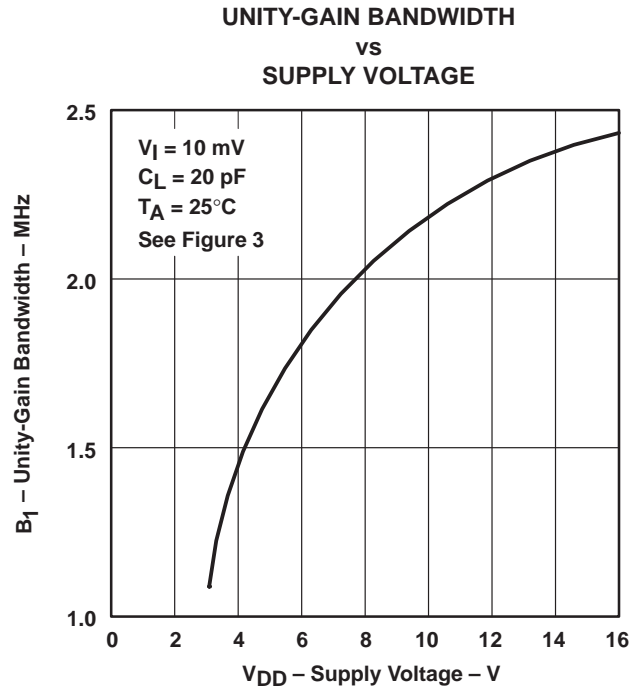
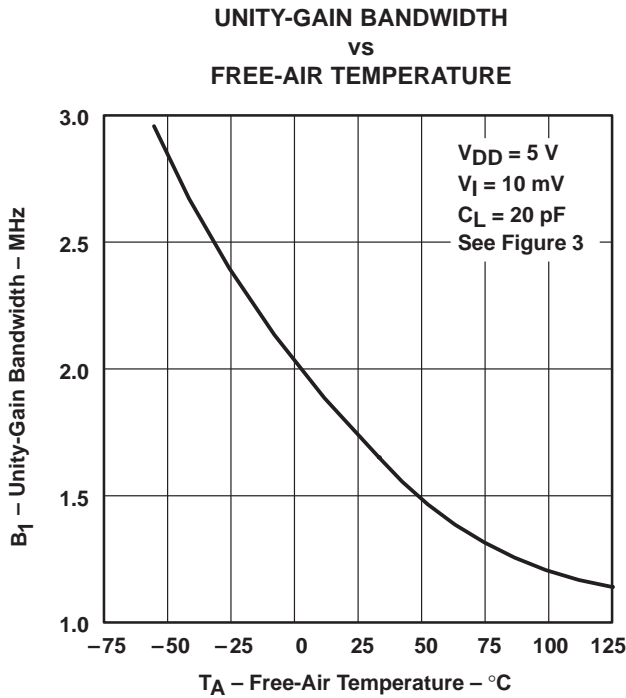

† Data at high and low temperatures are applicable only within the rated operating free-air temperature ranges of the various devices.

XD272 DIP8 / XL272 SOP8

TYPICAL CHARACTERISTICS†

LARGE-SIGNAL DIFFERENTIAL VOLTAGE AMPLIFICATION AND PHASE SHIFT

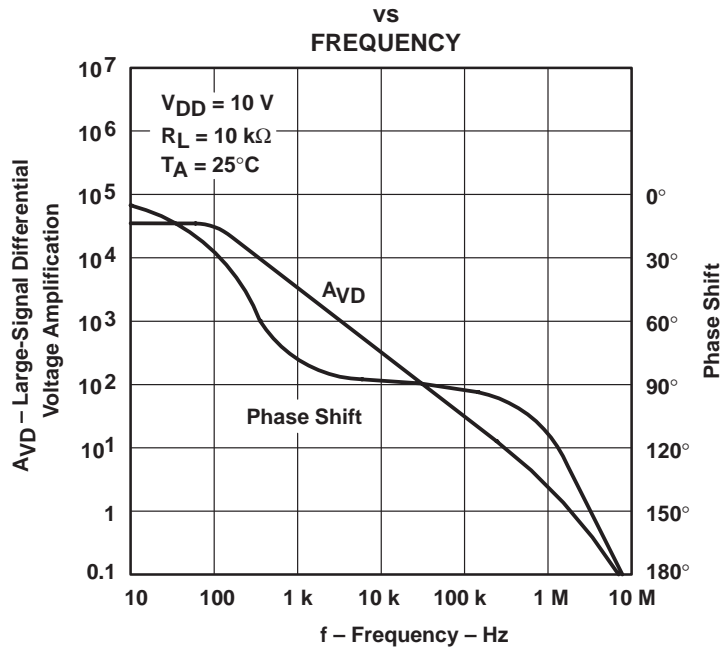

PHASE MARGIN vs SUPPLY VOLTAGE

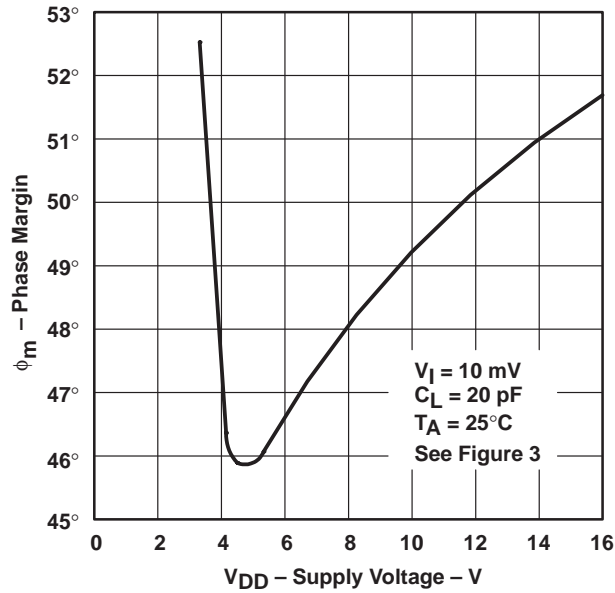

PHASE MARGIN vs FREE-AIR TEMPERATURE

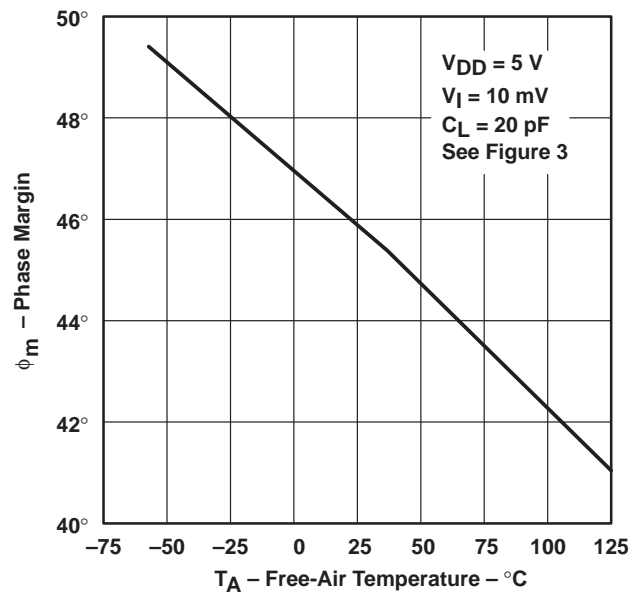

† Data at high and low temperatures are applicable only within the rated operating free-air temperature ranges of the various devices.

XD272 DIP8 / XL272 SOP8

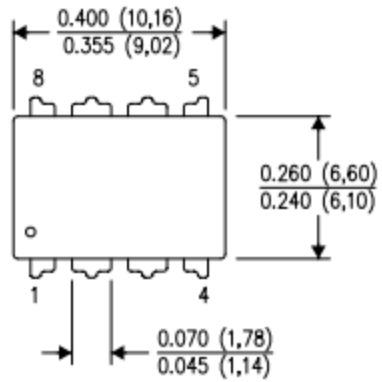

DIP

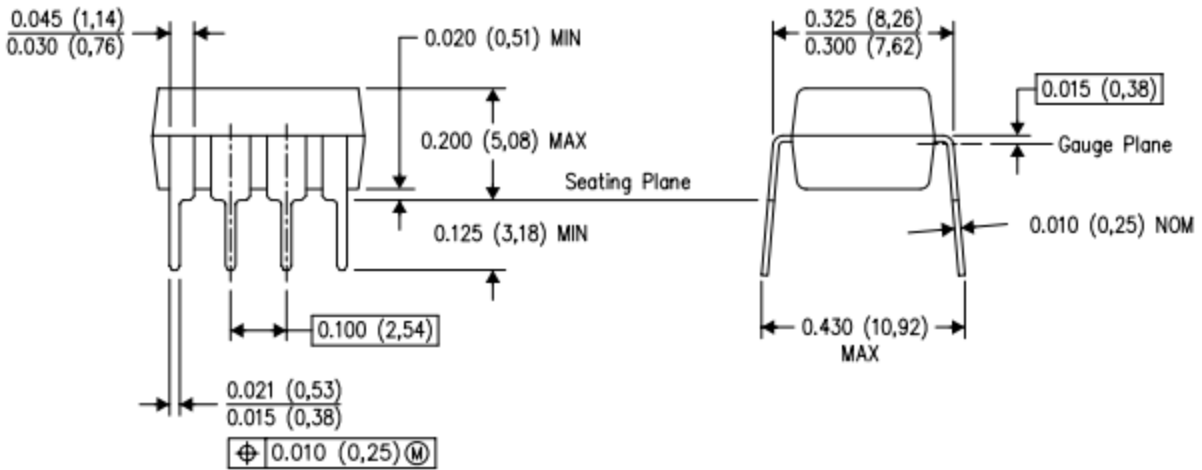

XD272 DIP8 / XL272 SOP8

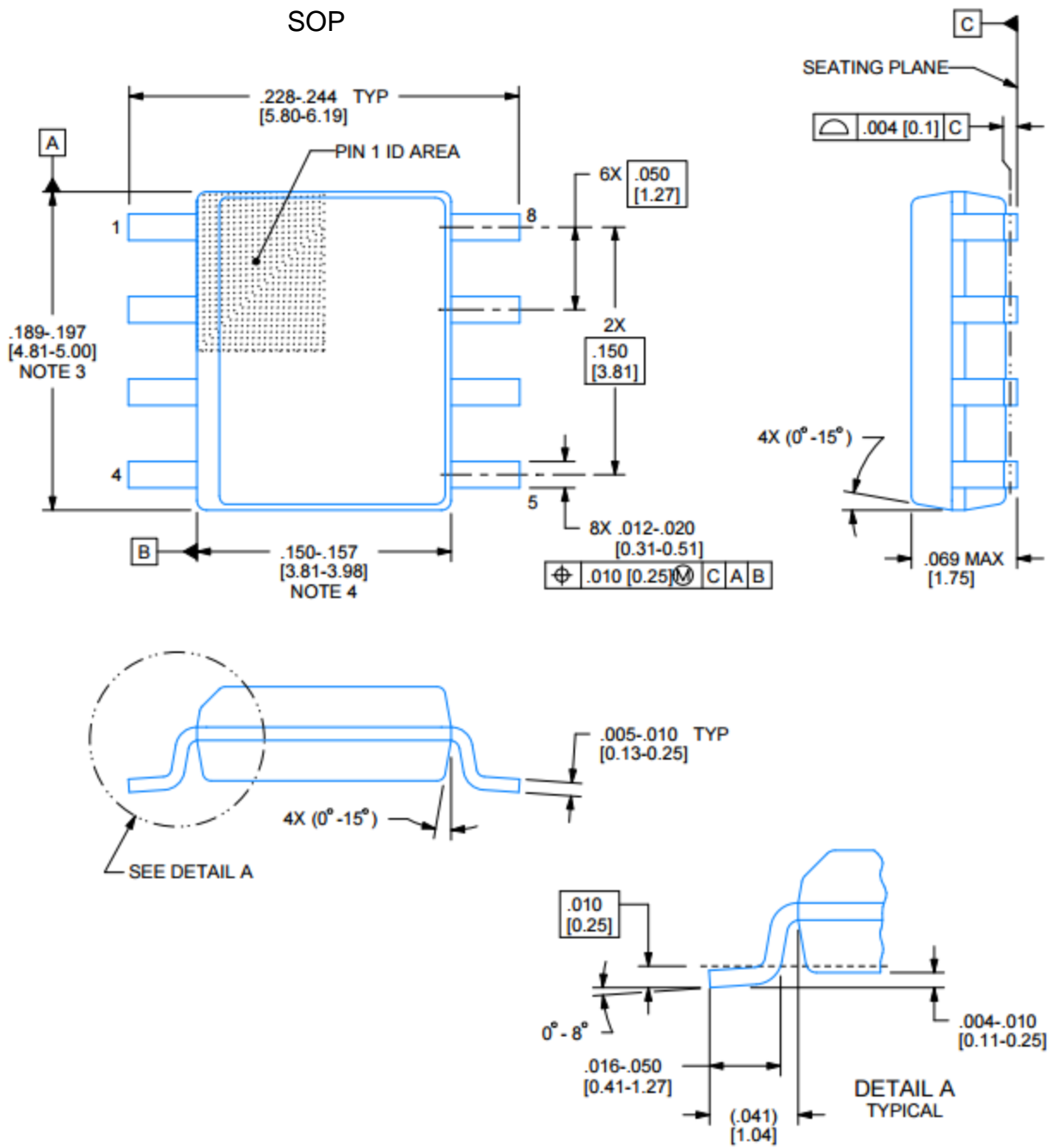

以上信息仅供参考. 如需帮助联系客服人员。谢谢 XINLUDA