

General Description

The WSD6056DN56 is the highest performance trench Dual N-Ch MOSFET with extreme high cell density, which provide excellent R_{DS(on)} and gate charge for most of the synchronous buck converter applications.

The WSD6056DN56 meet the RoHS and Green Product requirement 100% EAS guaranteed with full function reliability approved.

Features

- Advanced high cell density Trench technology
- Super Low Gate Charge
- Excellent CdV/dt effect decline
- 100% EAS Guaranteed
- Green Device Available

Product Summary

BVDSS	R _{DS(on)}	I _D
60V	16mΩ	45A

Applications

- High Frequency Point-of-Load Synchronous Buck Converter for MB/NB/UMPC/VGA
- Fast switching
- Load Switch

DFN5X6C-8-EP2 Pin Configuration

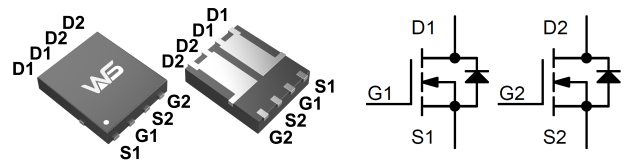

Absolute Maximum Ratings

Symbol	Parameter	Rating	Unit	
Common Ratings				
V _{DSS}	Drain-Source Voltage	60	V	
V _{GSS}	Gate-Source Voltage	±20	V	
T _J	Maximum Junction Temperature	150	°C	
T _{STG}	Storage Temperature Range	-55 to 150	°C	
I _S	Diode Continuous Forward Current	T _c =25°C	45	A
I _D	Continuous Drain Current	T _c =25°C	45	A
		T _c =70°C	28.5	
I _{DM} ^b	Pulse Drain Current Tested	T _c =25°C	180	A
P _D	Maximum Power Dissipation	T _c =25°C	67	W
		T _c =70°C	45	
R _{θJL}	Thermal Resistance-Junction to Lead	Steady State	5	°C/W
R _{θJA}	Thermal Resistance-Junction to Ambient	t ≤ 10s	45	°C/W
		Steady State ^b	90	
I _{AS} ^d	Avalanche Current, Single pulse	L=0.5mH	20	A
E _{AS} ^d	Avalanche Energy, Single pulse	L=0.5mH	20	mJ

Note a : Max. continuous current is limited by bonding wire.

Note b : Pulse width limited by max. junction temperature.

Note c : Surface mounted on 1in² pad area, steady state t = 999s.

Note d : UIS tested and pulse width limited by maximum junction temperature 150°C (initial temperature T_J=25°C).

Electrical Characteristics (T_J=25 °C, unless otherwise noted)

Symbol	Parameter	Test Conditions	Min.	Typ.	Max.	Unit
Static Characteristics						
BV _{DSS}	Drain-Source Breakdown Voltage	V _{GS} =0V, I _{DS} =250μA	60	-	-	V
I _{DSS}	Zero Gate Voltage Drain Current	V _{DS} =60V, V _{GS} =0V T _J =85°C	-	-	1	μA
			-	-	30	
V _{GS(th)}	Gate Threshold Voltage	V _{DS} =V _{GS} , I _{DS} =250μA	1.2	1.5	2.5	V
I _{GSS}	Gate Leakage Current	V _{GS} =±20V, V _{DS} =0V	-	-	±100	nA
R _{DS(ON)} ³	Drain-Source On-state Resistance	V _{GS} =10V, I _{DS} =20A	-	16	20	mΩ
		V _{GS} =4.5V, I _{DS} =15A	-	20	25	
Diode Characteristics						
V _{SD}	Diode Forward Voltage	I _{SD} =1A, V _{GS} =0V	-	0.75	1.2	V
t _{rr}	Reverse Recovery Time	I _{SD} =20A, dI _{SD} /dt=100A/μs	-	26	-	ns
Q _{rr}	Reverse Recovery Charge		-	30	-	nC
Dynamic Characteristics ^{3,4}						
R _G	Gate Resistance	V _{GS} =0V, V _{DS} =0V, F=1MHz	-	0.9	-	Ω
C _{iss}	Input Capacitance	V _{GS} =0V, V _{DS} =30V, F=1.0MHz	-	945	-	pF
C _{oss}	Output Capacitance		-	275	-	
C _{rss}	Reverse Transfer Capacitance		-	26	-	
t _{d(ON)}	Turn-on Delay Time	V _{DD} =30V, I _{DS} =1A, V _{GEN} =10V, R _G =3.3Ω.	-	10	-	ns
t _r	Turn-on Rise Time		-	13.5	-	
t _{d(OFF)}	Turn-off Delay Time		-	28	-	
t _f	Turn-off Fall Time		-	20	-	
Gate Charge Characteristics ^{3,4}						
Q _g	Total Gate Charge	V _{DS} =30V, V _{GS} =10V, I _{DS} =20A	-	28	-	nC
Q _g	Total Gate Charge	V _{DS} =30V, V _{GS} =10V, I _{DS} =20A	-	17.6	-	
Q _{gth}	Threshold Gate Charge		-	3.5	-	
Q _{gs}	Gate-Source Charge		-	2.7	-	
Q _{gd}	Gate-Drain Charge		-	6.3	-	

Note :

1. Repetitive Rating : Pulsed width limited by maximum junction temperature.
2. V_{DD}=48V, V_{GS}=10V, L=0.1mH, I_{AS}=20A., R_G=25Ω Starting T_J=25
3. The data tested by pulsed , pulse width<=300us , duty cycle<=2%.
4. Essentially independent of operating temperature.

Typical Operating Characteristics

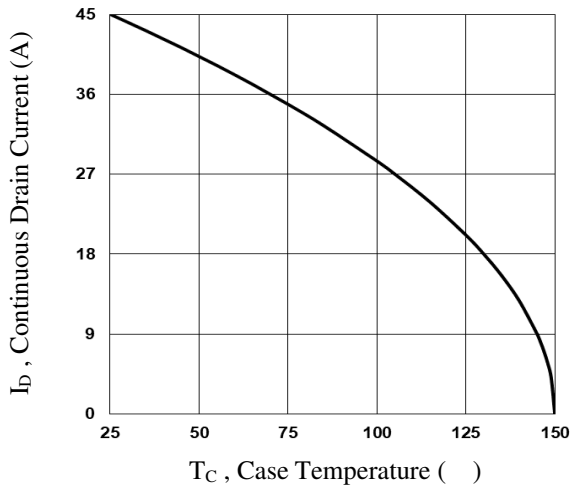

Fig.1 Continuous Drain Current vs. T_c

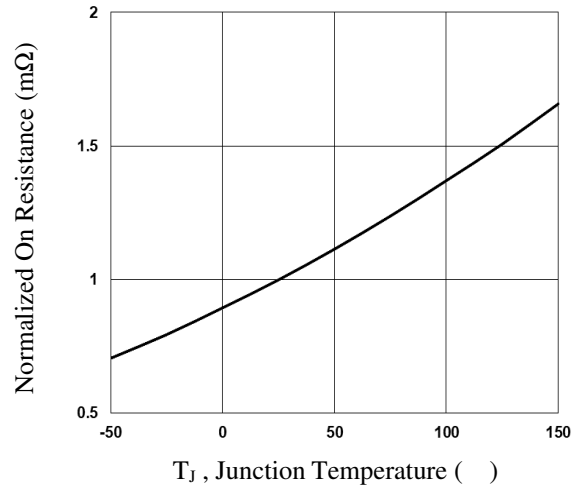

Fig.2 Normalized $R_{DS(on)}$ vs. T_j

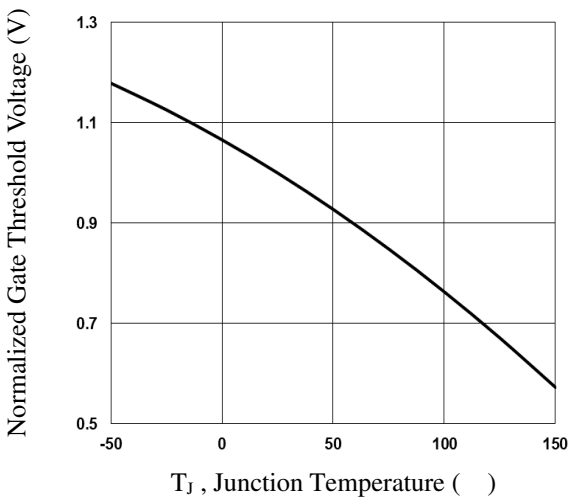

Fig.3 Normalized V_{th} vs. T_j

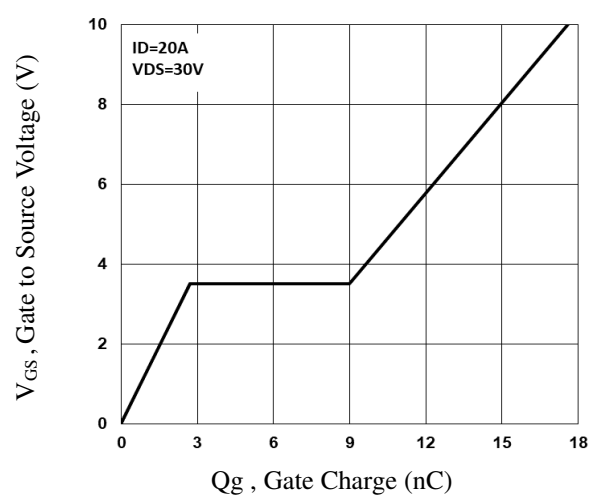

Fig.4 Gate Charge Waveform

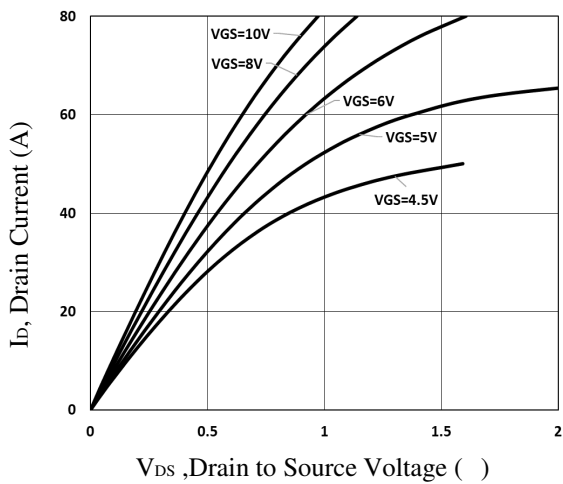

Fig.5 Typical Output Characteristics

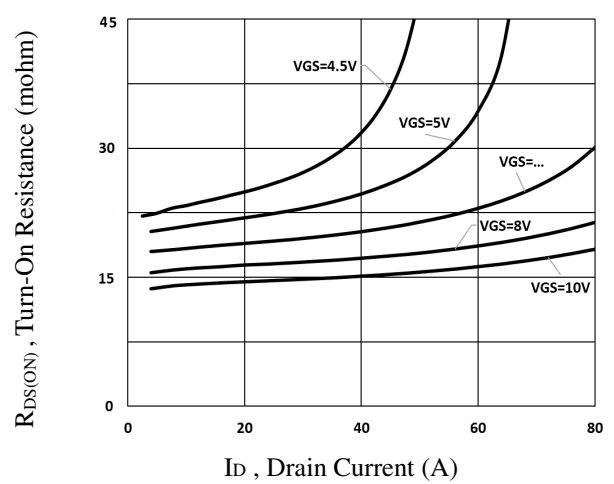

Fig.6 Turn-On Resistance vs. I_D

Typical Operating Characteristics(Cont.)

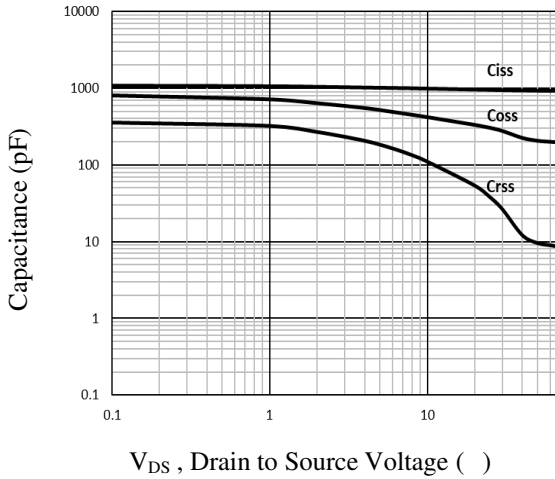

Fig.7 Capacitance Characteristics

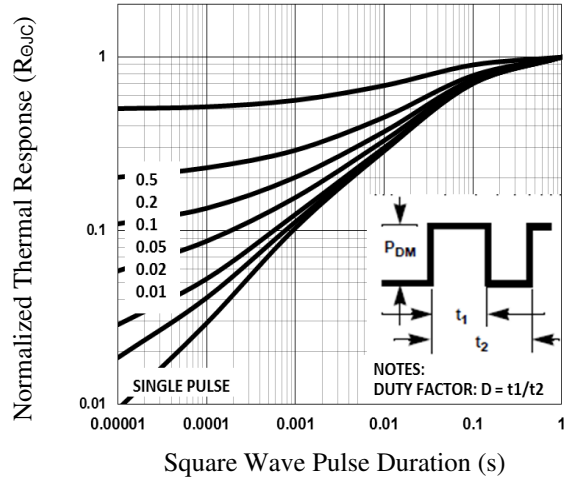

Fig.8 Normalized Transient Response

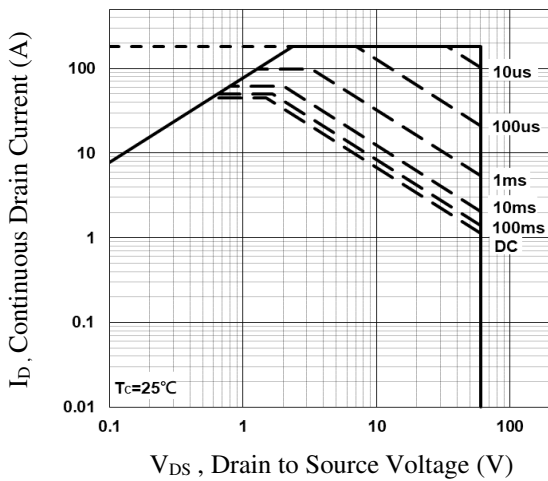

Fig.9 Maximum Safe Operation Area

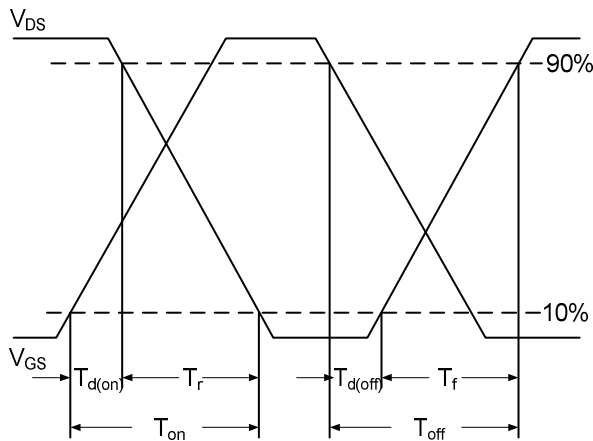

Fig.10 Switching Time Waveform

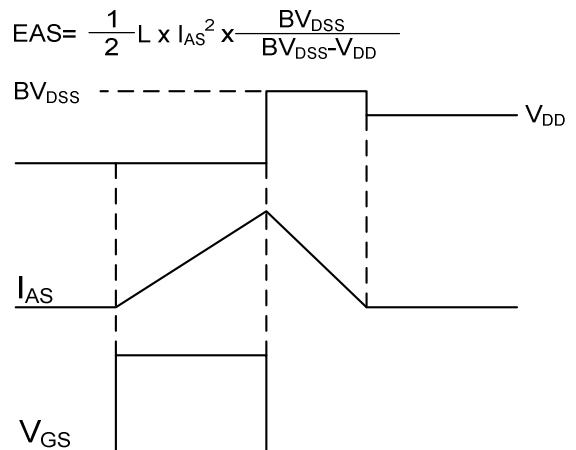

Fig.11 EAS Waveform



Attention

1, Any and all Winsok power products described or contained herein do not have specifications that can handle applications that require extremely high levels of reliability, such as life-support systems, aircraft's control systems, or other applications whose failure can be reasonably expected to result in serious physical and/or material damage. Consult with your Winsok power representative nearest you before using any Winsok power products described or contained herein in such applications.

2, Winsok power assumes no responsibility for equipment failures that result from using products at values that exceed, even momentarily, rated values (such as maximum ratings, operating condition ranges, or other parameters) listed in products specifications of any and all Winsok power products described or contained herein.

3, Specifications of any and all Winsok power products described or contained herein stipulate the performance, characteristics, and functions of the described products in the independent state, and are not guarantees of the performance, characteristics, and functions of the described products as mounted in the customer's products or equipment. To verify symptoms and states that cannot be evaluated in an independent device, the customer should always evaluate and test devices mounted in the customer's products or equipment.

4, Winsok power Semiconductor CO., LTD. strives to supply high-quality high-reliability products. However, any and all semiconductor products fail with some probability. It is possible that these probabilistic failures could give rise to accidents or events that could endanger human lives that could give rise to smoke or fire, or that could cause damage to other property. When designing equipment, adopt safety measures so that these kinds of accidents or events cannot occur. Such measures include but are not limited to protective circuits and error prevention circuits for safe design, redundant design, and structural design.

5, In the event that any or all Winsok power products (including technical data, services) described or contained herein are controlled under any of applicable local export control laws and regulations, such products must not be exported without obtaining the export license from the authorities concerned in accordance with the above law.

6, No part of this publication may be reproduced or transmitted in any form or by any means, electronic or mechanical, including photocopying and recording, or any information storage or retrieval system, or otherwise, without the prior written permission of Winsok power Semiconductor CO., LTD.

7, Information (including circuit diagrams and circuit parameters) herein is for example only; it is not guaranteed for volume production. Winsok power believes information herein is accurate and reliable, but no guarantees are made or implied regarding its use or any infringements of intellectual property rights or other rights of third parties.

8, Any and all information described or contained herein are subject to change without notice due to product/technology improvement, etc. When designing equipment, refer to the "Delivery Specification" for the Winsok power product that you intend to use.

9, this catalog provides information as of Sep.2014. Specifications and information herein are subject to change without notice.