

3 Quadrants TRIAC

Features

- IT(RMS): 6A
- VGT:1.3V
- VDRM VRRM: 600V and 800V

Applications

Washing machine,vacuums,
massager,solid state relay, AC
Motor speed regulation ,lighting
control ,temperature and so on.

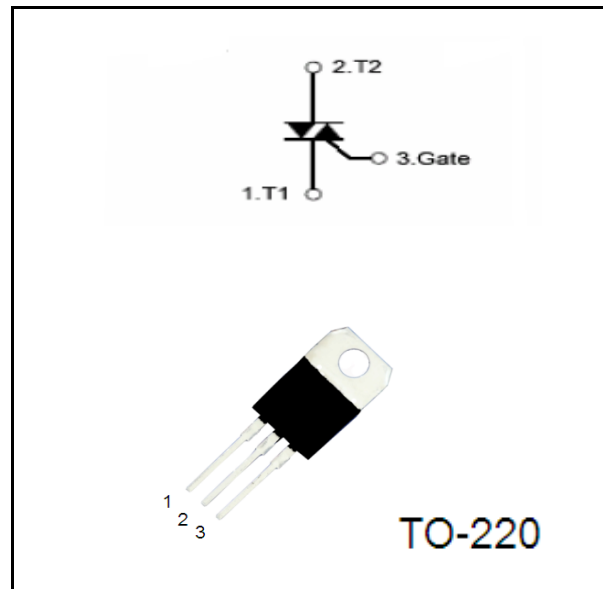

Absolute Maximum Ratings(Tc=25°C unless otherwise specified)

Symbol	parameter	Conditions	Ratings	Unit
VDRM VRRM	Repetitive Peak Off- State Voltage	BTA06-600	600	V
		BTA06-800	800	V
IT(RMS)	R.M.S On-State Current	Tc=110°C	6	A
ITSM	Surge On-State Current	f=50/60Hz tp=16.7ms/20ms	65/67	A
I ² t	I ² t for fusing	Tp=10ms	23	A ² s
PG(AV)	Average Gate Power Dissipation	Tj=125°C	1	W
IGM	Peak Gate Current	Tj=125°C	4	A
Tj	Operating Junction Temperature		-40~125	°C
TSTG	Storage Temperature		-40~150	°C

Electrical Characteristics(Tc=25°C unless otherwise specified)

symbol	parameter	Test Conditions	Value						Unit	
			TW	SW	CW	BW	C	B		
IDRM	Repetitive Peak Off-State Current	Tc=25°C	≤5						uA	
		Tc=125°C	≤1						mA	
IRRM	Repetitive Peak Reverse Current	Tc=25°C	≤5						uA	
		Tc=125°C	≤1						mA	
V _{TM}	Forward "on" voltage	I _T =10A t _p =380us	1.55						V	
V _{GT}	Gate trigger voltage	V _D =12V ,R _L =30Ω	≤1.3						V	
di/dt	Critical-rate of rise of commutation current.	I,II,III	IG=2XIGT, tr≤100ns, F=100Hz						A ² /us	
		IV	z						A ² /us	
IGT	Gate trigger current	I,II,III	V _D =12V	≤5	≤10	≤25	≤50	≤25	≤50	mA
		IV	R _L =30Ω	/	/	/	/	≤50	≤100	mA
I _H	Holding current	I _T =0.2A	≤10	≤15	≤35	≤60	≤25	≤50	mA	
V _{GD}	Gate non-trigger voltage	ALL	V _D =V _{DRM} T _J =125°C, R _L =3.3KΩ	≥0.2						V
dv/dt	Critical-rate of rise of commutation voltage	T _J =125°C V _D =2/3V _{DRM} Gate open circuit	≥20	≥50	≥400	≥1000	≥200	≥400	V/us	
R _{th(j-c)}	Thermal resistance	Junction to case	2.7						°C/W	
R _{th(j-a)}	Thermal resistance	Junction to ambient	60						°C/W	

characteristic curve

FIG.1:Gate characteristics

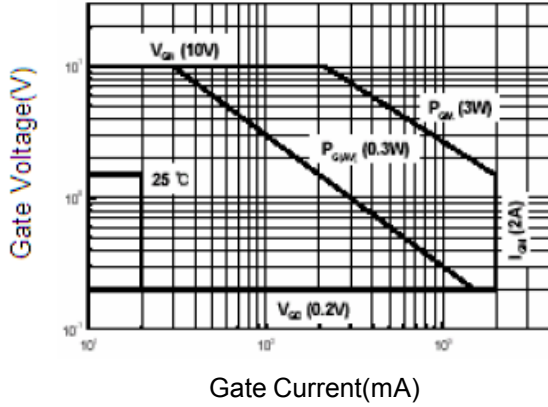

FIG.2: On-state characteristics(max)

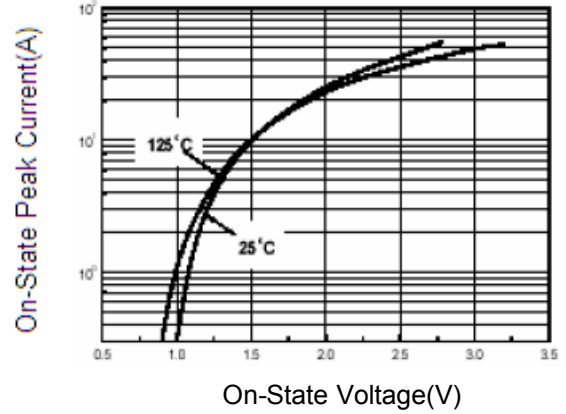

FIG.3:Gate trigger voltage vs junction temperature

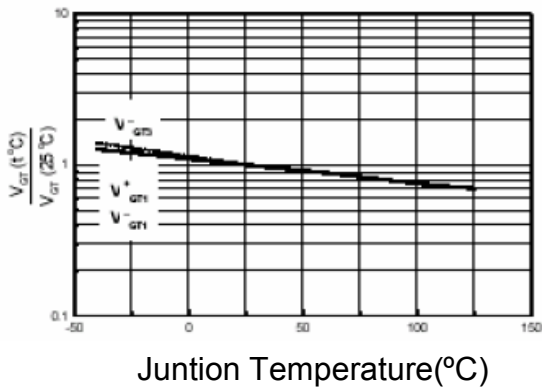

FIG.4:on-state current vs max power Dissipation

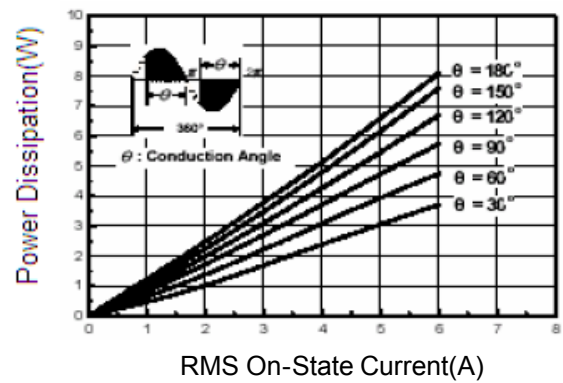

FIG.5:RMS On-state vs Allowable Case Temperature

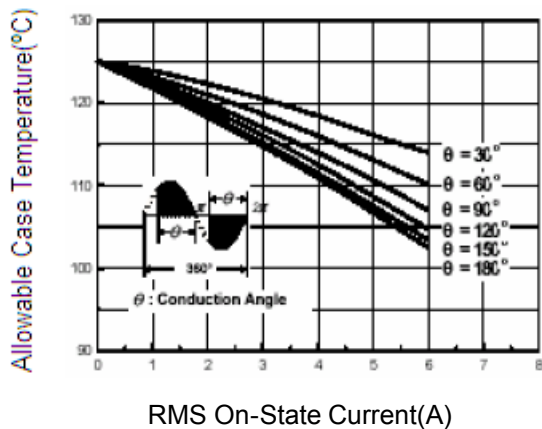
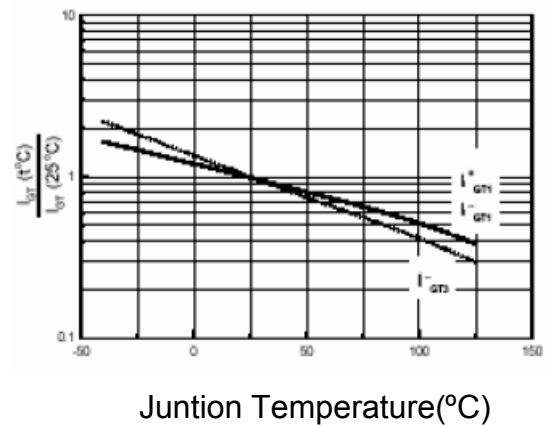
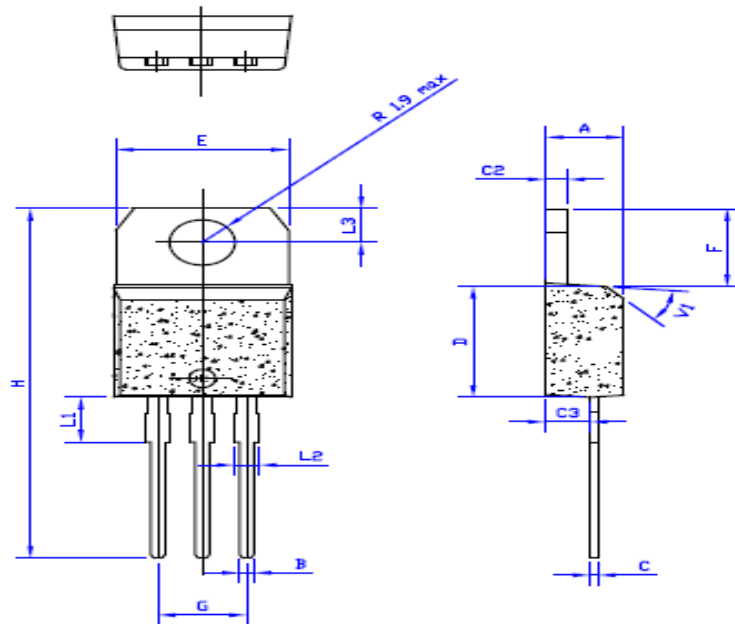

FIG.6:Gate trigger current vs junction temperature



PACKAGE MECHANICAL DATA

TO-220 Package Dimension



Ref.	Dimensions					
	Millimeters			Inches		
	Min.	Typ.	Max.	Min.	Typ.	Max.
A	4.4		4.6	0.173		1.181
B	0.61		0.88	0.024		0.034
C	0.46		0.70	0.018		0.027
C2	1.23		1.32	0.048		0.051
C3	2.4		2.72	0.094		0.107
D	8.6		9.7	0.338		0.382
E	9.8		10.4	0.386		0.409
F	6.2		6.6	0.244		0.259
G	4.8		5.4	0.189		0.213
H	28.0		29.8	11.0		11.7
L1		3.75			0.147	
L2	1.14		1.7	0.044		0.066
L3	2.65		2.95	0.104		0.116
V1		40°			40°	