



MU-105-ACW
W6.20xD7.20xH2.40

PIN数(Number of contacts) : 5PIN	插座类型(Socket type) : MICRO USB
插座类别(Socket category): 母座/Mother seat	操作方式(Operation mode): 卧式/Horizontal
温度范围(Operating temp): -20°C TO +70°C	操作寿命(Operation life): 5,000 Cycles Min
额定负荷(Rated load): DC 30V 1.5A	焊接方式(Welding mode): 贴片式/SMT
接触电阻(Contact resistance): $\leq 50m\Omega$	包装方式(Packaging method): 卷带/Tape&Reel(TR)
绝缘电阻(Insulation resistance): $\geq 1000M\Omega$	最小包装(Minimum packing): 1,500/PCS

外形尺寸(UNIT:MM) / Size Chart

www.xunpudianzi.com

更多资料请参考技术选型档!

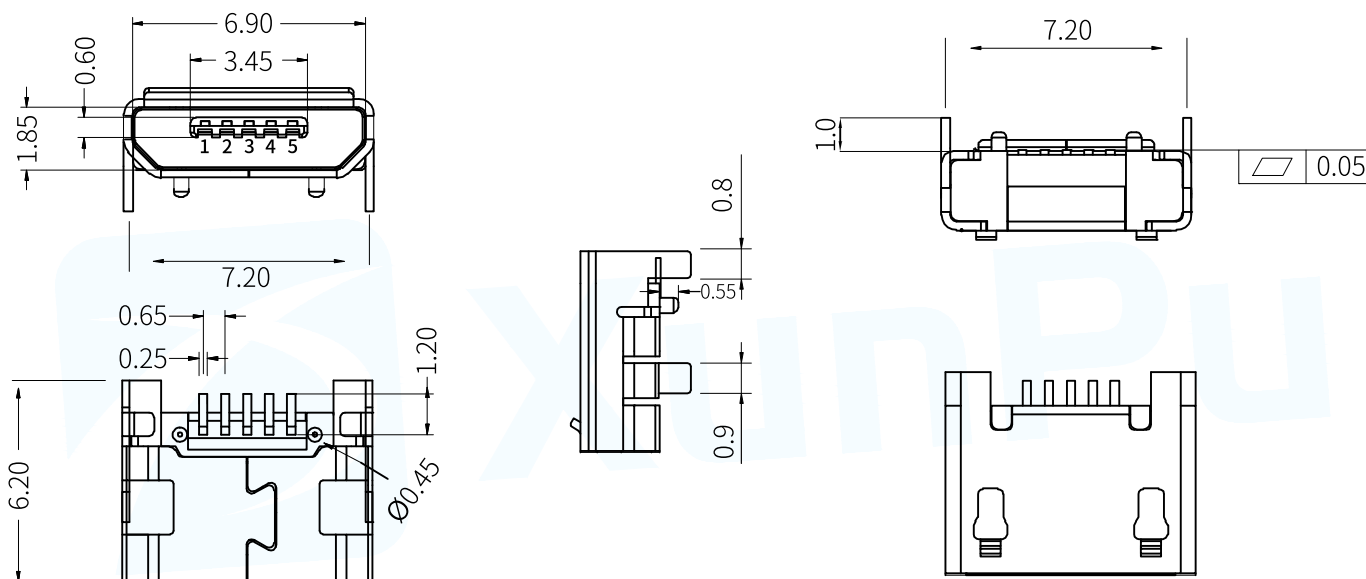

线路板安装(UNIT:MM) / Mounting Dimensions

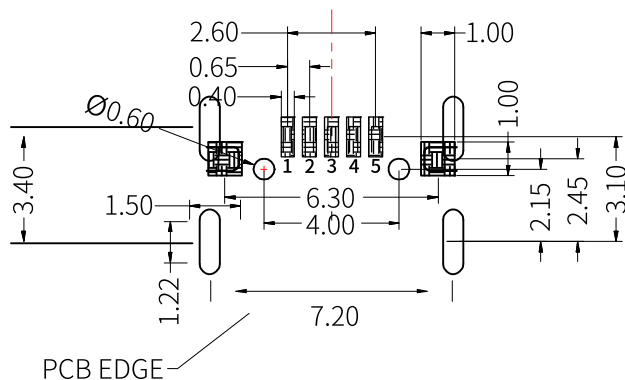

P.C.B LAYOUT(copper-side view)

● 引脚定义/Pin Definition

PIN	Signal Name	Describe
1	VBUS	+5V
2	D-	Neagative Data Channel
3	D+	Positive Data Channel
4	ID	OTG
5	GND	Ground

● 回流焊/Reflow soldering

适用表面贴装型产品/Applicable to surface mount products
温度分布/Temperature distribution



注:

1. 加热方式:以远红外线上下加热方式。
2. 温度测量:用 $\phi 0.1\sim 0.2$ 的 CA(K)或 CC(T)测量位置在焊接连接部(锡/铜箔面)。
3. 固定方式:采用耐热胶带。

● 手焊式/Hand welding

项目/Project	条件/condition
焊接温度 Welding temperature	350°C max.
持续焊接时间 Continuous welding time	3s max.
焊剂斗容量 Flux bucket capacity	60W max.

● 浸焊式/Immersion soldering

项目/Project	条件/condition
助焊剂附着量 Flux adhesion	不附着于零部件贴装面的程度 Not attached to the mounting surface of components
预热温度 Preheating temperature	印刷电路板焊接面的周围温度 100°C max. The temperature around the welding surface of PCB is 100 °C max
预热温度时间 Preheat temperature time	60s max.
焊接温度 welding temperature	260°C max.
焊接浸渍时间 Welding immersion time	5s max.
焊接次数 Welding times	2 times max.