

CSNP1GCR01-AMW

Version: V1.2

JAN20, 2021



Revision History

Version	Date	Description
V1.0	20/05/2019	Origin Draft
V1.1	16/08/2019	Add CSR Value
V1.2	20/01/2021	Updated operating temperature



Contents

REVISION HISTORY	I
1. INTRODUCTION	1
1.1 OVERVIEW	1
1.2 FEATURES	1
1.4 BLOCK DIAGRAM	1
2. PRODUCT SPECIFICATIONS	2
2.1 PIN ASSIGNMENTS (TOP VIEW)	2
2.2 PACKAGE DIMENSIONS	2
3. PERFORMANCE	4
4. DC CHARACTERISTICS	5
5. AC CHARACTERISTICS	6
5.1 BUS TIMING (DEFAULT MODE)	6
5.2 BUS TIMING (HIGH-SPEED MODE)	6
6. SDNAND INITIALIZATION	8
7. DATA TRANSFER MODE	9
8. SDNAND REGISTERS	10
8.1 OCR REGISTER	10
8.2 CID REGISTER	11
8.3 CSD REGISTER	11
8.4 RCA REGISTER	12
8.5 DSR REGISTER	12
8.6 SCR REGISTER	12
9. POWER UP	14
9.2 POWER UP TIME	14
9.2.1 Power On or Power Cycle	14
9.2.2 Power Supply Ramp Up	15
10. REFERENCE DESIGN	16



1. Introduction

1.1 Overview

CSNP1GCR01-AMW is an 1Gb density of embedded storage based on NAND Flash and SD controller. This product has many advantages comparing to raw NAND, it has embedded bad block management, and stronger embedded ECC. Even on abnormal power down it still keep your data safely.

CSNP1GCR01-AMW is LGA-8 package. The size is 8mm x 6mm x0.75mm.

1.2 Features

- Interface: Standard SD Specification Version 2.0 with 1-I/O and 4-I/O.
- Power supply: $V_{cc} = 2.7V - 3.6V$
- Default mode: Variable clock rate 0 - 25 MHz, up to 12.5 MB/sec interface speed (using 4 parallel data lines)
- High-Speed mode: Variable clock rate 0 - 50 MHz, up to 25 MB/sec interface speed (using 4 parallel data lines)
- Operating Temperature: $-40^{\circ}C$ to $+85^{\circ}C$
- Storage Temperature: $-55^{\circ}C$ to $+125^{\circ}C$
- Standby Current: $< 250\mu A$
- Switch function command supports High-Speed, eCommerce, and future functions
- Correction of memory field errors
- Content Protection Mechanism - Complies with highest security of SDMI standard.
- Password Protection of SDNAND (CMD42 - LOCK_UNLOCK)
- Write Protect feature using mechanical switch
- Built-in write protection features (permanent and temporary)
- Application specific commands
- Comfortable erase mechanism

1.4 Block Diagram

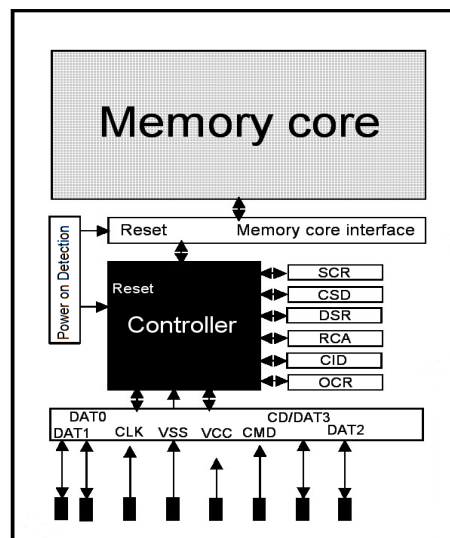



2. Product Specifications

2.1 Pin Assignments (Top View)

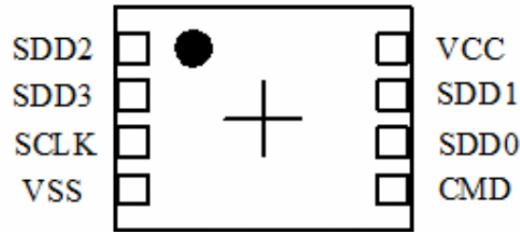

PIN#	SD MODE			SPI MODE		
	NAME	TYPE ¹	DESCRIPTION	NAME	TYPE	DESCRIPTION
1	SDD2	I/O/PP	Data Line [Bit2]	RSV		Reserved
2	CD/SDD3 ²	I/O/PP ³	SDNAND Detect/ Data Line [Bit3]	CS	I ³	Chip Select (Neg True)
3	SCLK	I	Clock	SCLK	I	Clock
4	VSS	S	Supply Voltage Ground	VSS	S	Supply Voltage Ground
5	CMD	PP	Command/Response	DI	I	Data In
6	SDD0	I/O/PP	Data Line [Bit0]	DO	O/PP	Data Out
7	SDD1	I/O/PP	Data Line [Bit1]	RSV		Reserved
8	VCC	S	Supply Voltage	VCC	S	Supply Voltage

1) S: power supply; I: input; O: output using push-pull drivers; PP: I/O using push-pull drivers;

2) The extended SDD lines (SDD1-SDD3) are input on power up. They start to operate as SDD lines after SET_BUS_WIDTH command. The Host shall keep its own SDD1-SDD3 lines in input mode, as well, while they are not used. It is defined so, in order to keep compatibility to SDNAND.

2.2 Package Dimensions

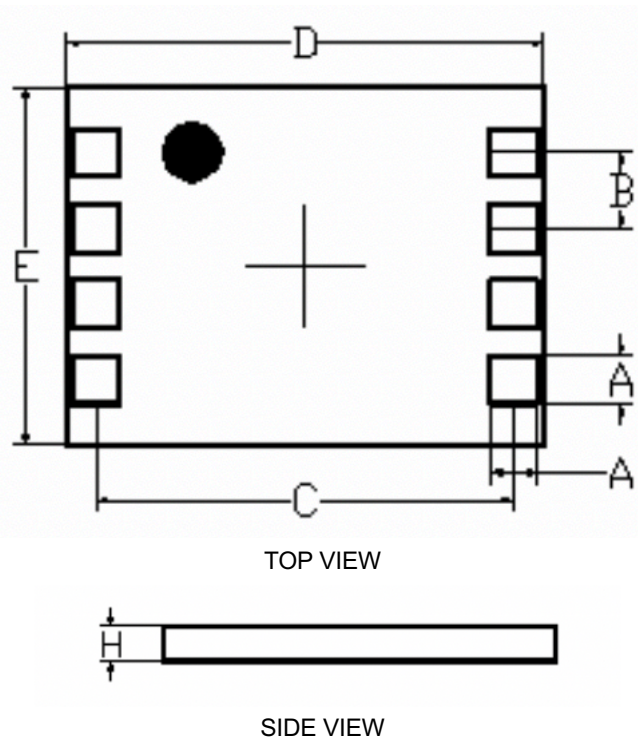



Symbol	Common Dimensions			Note
	Min	Nom	Max	
A	0.65	0.75	0.85	
B	1.17	1.27	1.37	
C	6.90	7	7.10	
D	7.90	8	8.10	
E	5.90	6	6.10	
F	10.90	11	11.1	
H	0.75	0.85	0.95	

SDNAND Package Dimensions (unit: mm)



3. Performance

Test Item	Test Mode	Result
HD Bench (100MB)	Sequential Read (MB/s)	16.4
	Sequential Write (MB/s)	4.6
Crystal Disk Mark (100MB)	Sequential Read (MB/s)	16.86
	Sequential Write (MB/s)	4.19
IO Meter (100MB)	Random Write (IOPS)	313.0
	Random Read (IOPS)	362.5
Test Metrix	Sequential Read (MB/s)	16.91
	Sequential Write (MB/s)	4.35
H2test	Sequential Read (MB/s)	15.6
	Sequential Write (MB/s)	4.57

Parameter	Range	
Temperature	Work Model	-40° ~ 85°C
	Storage Model	-55° ~ 125°C
Humidity	Work Model	8% to 95%, Non-condensing
	Storage Model	8% to 95%, Non-condensing



4. DC Characteristics

Symbol	PARAMETER	CONDITIONS	MIN	TYP	MAX	UNITS
V _{IL}	Input low voltage		VSS-0.3		0.25VCC	V
V _{IH}	Input high voltage		0.625VCC		VCC+0.3	V
V _{OL}	Output low voltage	I _{OL} =100μA @VCC_min			0.125VCC	V
V _{OH}	Output high voltage	I _{OH} =100μA @VCC_min	0.75VCC			V
I _{IN}	Input leakage current	V _{IN} =VCC or 0	-10	+/-1	10	μA
I _{OUT}	Tri-state output leakage current		-10	+/-1	10	μA
I _{STBY}	Standby current	3.3V@clock stop		180	250	μA
I _{OP}	Operation current	3.3v@50MHz (Write)		15	50	mA
		3.3v@50MHz (Read)		15	60	mA



5. AC Characteristics

5.1 Bus Timing (Default Mode)

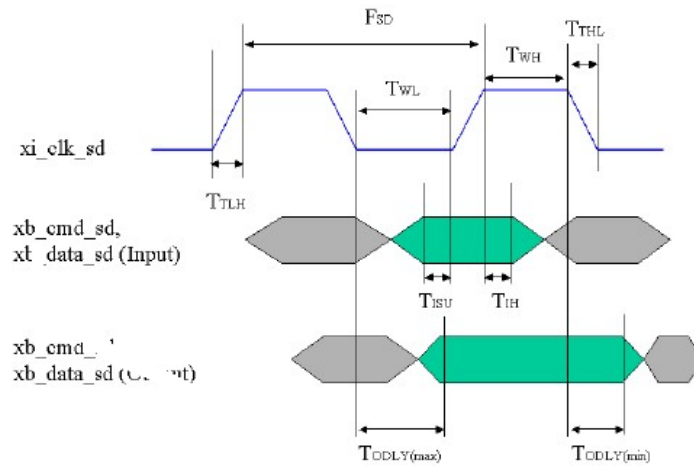

SYMBOL	PARAMETER	MIN	MAX	UNIT	NOTE
F_{SD}	SD clock frequency	0	25	MHz	
T_{WL}	Clock low time	10		ns	
T_{WH}	Clock high time	10		ns	
T_{TLH}	Clock rise time		10	ns	
T_{THL}	Clock fall time		10	ns	
T_{ISU}	Input setup time	5		ns	
T_{IH}	Input hold time	5		ns	
T_{ODLY}	Output delay time	0	14	ns	

5.2 Bus Timing (High-speed Mode)

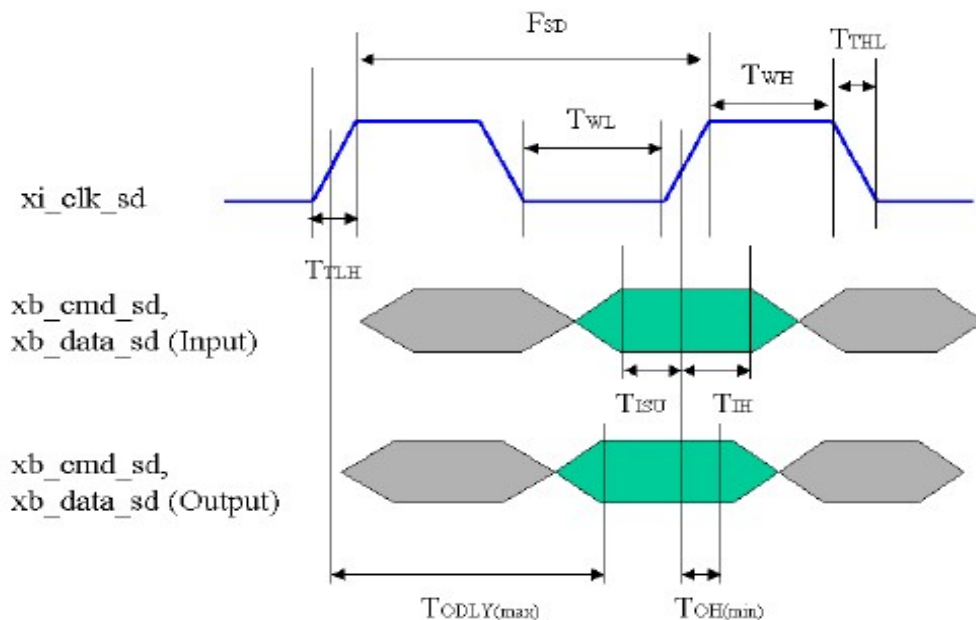



SYMBOL	PARAMETER	MIN	MAX	UNIT	NOTE
F _{SD}	SD clock frequency	0	25	MHz	
T _{WL}	Clock low time	10		ns	
T _{WH}	Clock high time	10		ns	
T _{TLH}	Clock rise time		10	ns	
T _{THL}	Clock fall time		10	ns	
T _{ISU}	Input setup time	5		ns	
T _{IH}	Input hold time	5		ns	
T _{ODLY}	Output delay time	0	14	ns	
T _{OH}	Output hold time	2.5		ns	



6. SDNAND Initialization

After the bus is activated the host starts SDNAND initialization and identification process. The initialization process starts with SD_SEND_OP_COND (ACMD41) by setting its operational conditions and the HCS bit in the OCR. The HCS (Host Capacity Support) bit set to 1 indicates that the host supports High Capacity SDNAND. The HCS (Host Capacity Support) bit set to 0 indicates that the host does not support High Capacity SDNAND.

Receiving of CMD8 expands the ACMD41 function; HCS in the argument and CCS (SDNAND Capacity Status) in the response. HCS is ignored by SDNANDs, which didn't respond to CMD8. However, the host should set HCS to 0 if the SDNAND returns no response to CMD8. Standard Capacity SDNAND ignores HCS. If HCS is set to 0, High Capacity SDNAND never return ready status (keep busy bit to 0). The busy bit in the OCR is used by the SDNAND to inform the host that initialization of ACMD41 is completed. Setting the busy bit to 0 indicates that the SDNAND is still initializing. Setting the busy bit to 1 indicates completion of initialization. The host repeatedly issues ACMD41 until the busy bit is set to 1.

The SDNAND checks the operational conditions and the HCS bit in the OCR only at the first ACMD41. While repeating ACMD41, the host shall not issue another command except CMD0.

If the SDNAND responds to CMD8, the response of ACMD41 includes the CCS field information. CCS is valid when the SDNAND returns ready (the busy bit is set to 1). CCS=1 means that the SDNAND is a High Capacity SDNAND.

CCS=0 means that the SDNAND is a Standard Capacity SDNAND.

The host performs the same initialization sequence to all of the new SDNANDs in the system. Incompatible SDNANDs are sent into Inactive State. The host then issues the command ALL_SEND_CID (CMD2), to each SDNAND to get its unique SDNAND identification (CID) number. SDNAND that is unidentified (i.e. which is in Ready State) sends its CID number as the response (on the CMD line). After the CID was sent by the SDNAND it goes into Identification State. Thereafter, the host issues CMD3 (SEND_RELATIVE_ADDR) asks the SDNAND to publish a new relative SDNAND address (RCA), which is shorter than CID and which is used to address the SDNAND in the future data transfer mode. Once the RCA is received the SDNAND state changes to the Stand-by State. At this point, if the host wants to assign another RCA number, it can ask the SDNAND to publish a new number by sending another CMD3 command to the SDNAND. The last published RCA is the actual RCA number of the SDNAND.

The host repeats the identification process, i.e. the cycles with CMD2 and CMD3 for each SDNAND in the system.

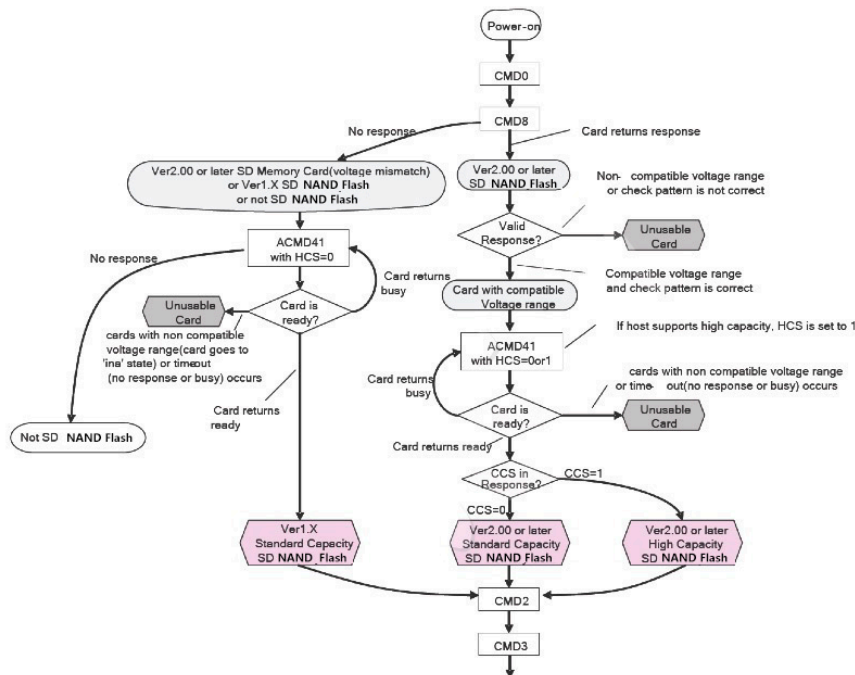

SDNAND Initialization and Identification Flow



7. Data Transfer Mode

Until the end of SDNAND Identification Mode the host shall remain at F_{OD} frequency because some SDNAND may have operating frequency restrictions during the SDNAND identification mode. In Data Transfer Mode the host may operate the SDNAND in f_{PP} frequency range. The host issues SEND_CSD (CMD9) to obtain the SDNAND Specific Data (CSD register), e.g. block length, SDNAND storage capacity, etc.

The broadcast command SET_DSR (CMD4) configures the driver stages of all identified SDNAND. It programs their DSR registers corresponding to the application bus layout (length) and the number of SDNAND on the bus and the data transfer frequency. The clock rate is also switched from F_{OD} to F_{PP} at that point. SET_DSR command is an option for the SDNAND and the host.

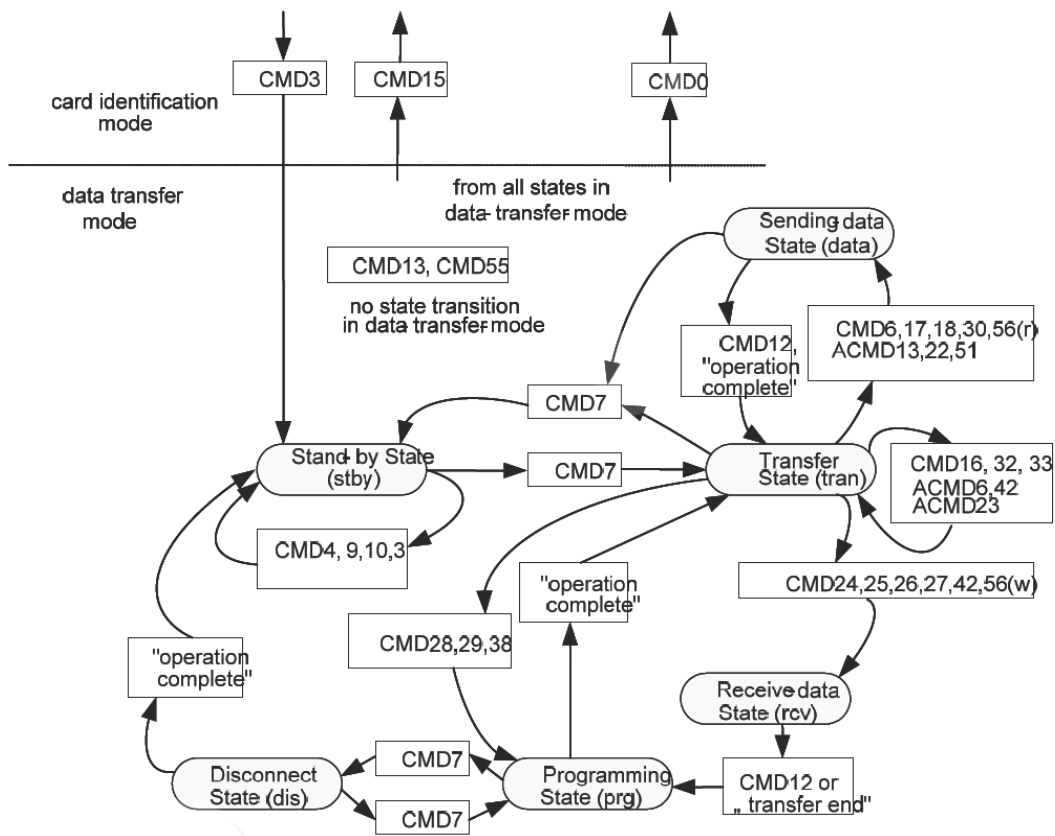

SDNAND State Diagram (data transfer mode)



8. SDNAND Registers

Six registers are defined within the SDNAND interface: OCR, CID, CSD, RCA, DSR and SCR. These can be accessed only by corresponding commands. The OCR, CID, CSD and SCR registers carry the SDNAND/content specific information, while the RCA and DSR registers are configuration registers storing actual configuration parameters. In order to enable future extension, The SDNAND shall return 0 in the reserved bits of the registers.

Name	Width	Description
CID	128	SDNAND identification number; SDNAND individual number for identification
RCA1	16	Relative SDNAND address; local system address of a SDNAND, dynamically suggested by the SDNAND and approved by the host during initialization
DSR	16	Driver Stage Register; to configure the SDNAND's output drivers
CSD	128	SDNAND Specific Data; information about the SDNAND operation conditions
SCR	64	SD Configuration Register; information about the SDNAND's Special Features capabilities
OCR	32	Operation conditions register.
SSR	512	SD Status; information about the SDNAND proprietary features
CSR	32	SDNAND Status; information about the SDNAND status

SDNAND Registers

8.1 OCR register

The 32-bit operation conditions register stores the VCC voltage profile of the SDNAND. Additionally, this register includes status information bits. One status bit is set if the SDNAND power up procedure has been finished. This register includes another status bit indicating the SDNAND capacity status after set powerup status bit. The OCR register shall be implemented by the SDNAND. The 32-bit operation conditions register stores the VCC voltage profile of the SDNAND. Bit 7 of OCR is newly defined for Dual Voltage SDNAND and set to 0 in default. If a Dual Voltage SDNAND does not receive CMD8, OCR bit 7 in the response indicates 0, and the Dual Voltage SDNAND which received CMD8, sets this bit to 1. Additionally, this register includes 2 more status information bits. Bit 31 - SDNAND power up status bit, this status bit is set if the SDNAND power up procedure has been finished. Bit 30 - SDNAND capacity status bit, this status bit is set to 1 if SDNAND is High Capacity SDNAND. 0 indicates that the SDNAND is Standard Capacity SDNAND. The SDNAND Capacity status bit is valid after the SDNAND power up procedure is completed and the SDNAND powerup status bit is set to 1. The Host shall read this status bit to identify a Standard or High Capacity SDNAND. The OCR register shall be implemented by the SDNANDs.

OCR bit position	VCC voltage window	Initial Value
		1Gb
31	SDNAND powerup status bit (busy)	"0" = busy "1" = ready
30	SDNAND Capacity Status	"0" = SDNAND "1" = SDHC Memory SDNAND
29-25	Reserved	All '0'
24	Switching to 1.8V Accepted (S18A)	0
23	3.6-3.5	1
22	3.5-3.4	1
21	3.4-3.3	1
20	3.3-3.2	1
19	3.2-3.1	1
18	3.1-3.0	1



17	3.0-2.9	1
16	2.9-2.8	1
15	2.8-2.7	1
14	Reserved	0
13	Reserved	0
12	Reserved	0
11	Reserved	0
10	Reserved	0
9	Reserved	0
8	Reserved	0
7	Reserved for Low Voltage Range	0
6	Reserved	0
5	Reserved	0
4	Reserved	0
3-0	Reserved	All '0'

8.2 CID register

The SDNAND Identification (CID) register is 128 bits wide. It contains the SDNAND identification information used during the SDNAND identification phase. Every individual Read/Write (RW) SDNAND shall have a unique identification number. The structure of the CID register is defined in the following paragraphs:

Name	Field	Width	CID-slice	Initial Value
				1Gb
Manufacturer ID	MID	8	[127:120]	66
OEM/Application ID	OID	16	[119:104]	2346
Product name	PNM	40	[103:64]	CS001
Product revision	PRV	8	[63:56]	01
Product serial number	PSN	32	[55:24]	(a) (Product serial number)
Reserved	-	4	[23:20]	All "0b"
Manufacturing date	MDT	12	[19:8]	(a)(Manufacture date)
CRC7 checksum	CRC	7	[7:1]	(b)(CRC)
Not used, always 1	-	1	[0:0]	1b

8.3 CSD Register

The SDNAND-Specific Data register provides information regarding access to the SDNAND contents.

The CSD defines the data format, error correction type, maximum data access time, whether the DSR register can be used, etc. The programmable part of the register (entries marked by W or E, see below) can be changed by CMD27. The types of the entries in the table below are coded as follows: R = readable, W (1) = writable once, W = multiple writable.

Name	Field	Width	Value	Cell Type	CSD-slice
CSD structure	CSD_STRUCTURE	2	00b	R	[127:126]
Reserved	-	6	00 0000b	R	[125:120]
Data read access-time	(TAAC)	8	0x7fh	R	[119:112]
Data read access-time in CLK	(NSAC)	8	0xffh	R	[111:104]



Cycles (NSAC*100)					
Max. data transfer rate	(TRAN_SPEED)	8	32h	R	[103:96]
SDNAND command classes	CCC	12	0x5b5h	R	[95:84]
Max. read data block length	(READ_BL_LEN)	4	0x9h(1001b)	R	[83:80]
Partial blocks for read allowed	(READ_BL_PARTIAL)	1	1b	R	[79:79]
Write block misalignment	(WRITE_BLK_MISALIGN)	1	0b	R	[78:78]
Read block misalignment	(READ_BLK_MISALIGN)	1	0b	R	[77:77]
DSR implemented	DSR_IMP	1	0b	R	[76:76]
Reserved	-	2	00b	R	[75:70]
Device size	C_SIZE	12	0x1d9h	R	[69:48]
Reserved	-	1	0	R	[47:47]
Erase single block enable	(ERASE_BLK_EN)	1	1b	R	[46:46]
Erase sector size	(SECTOR_SIZE)	7	0x3fh	R	[45:39]
Write protect group size	(WP_GRP_SIZE)	7	0x7fh	R	[38:32]
Write protect group enable	(WP_GRP_ENABLE)	1	1b	R	[31:31]
Reserved	-	2	00b	R	[30:29]
Write speed factor	(R2W_FACTOR)	3	011b	R	[28:26]
Max. write data block length	(WRITE_BL_LEN)	4	1010b	R	[25:22]
Partial blocks for write allowed	(WRITE_BL_PARTIAL)	1	0b	R	[21:21]
Reserved	-	5	00000b	R	[20:16]
File format group	(FILE_FORMAT_GRP)	1	0b	R	[15:15]
Copy flag (OTP)	COPY	1	0b	R/W(1)	[14:14]
Permanent write protection	PERM_WRITE_PROTECT	1	0b	R/W(1)	[13:13]
Temporary write protection	TMP_WRITE_PROTECT	1	0b	R/W	[12:12]
File format	(FILE_FORMAT)	2	00b	R	[11:10]
Reserved	-	2	00b	R	[9:8]
CRC	CRC	7	0x6dh	R/W	[7:1]
Not used, always '1'	-	1	1b	-	[0:0]

8.4 RCA register

The writable 16-bit relative SDNAND address register carries the SDNAND address that is published by the SDNAND during the SDNAND identification. This address is used for the addressed host-SDNAND communication after the SDNAND identification procedure. The default value of the RCA register is 0x0000. The value 0x0000 is reserved to set all SDNANDs into the Stand-by State with CMD7.

8.5 DSR register

The 16-bit driver stage register is described in detail in Chapter 6.5. It can be optionally used to improve the bus performance for extended operating conditions (depending on parameters like bus length, transfer rate or number of SDNANDs). The CSD register carries the information about the DSR register usage. The default value of the DSR register is 0x404.

8.6 SCR register

In addition to the CSD register, there is another configuration register named SDNAND Configuration Register (SCR). SCR provides information on the SDNAND's special features that were configured into the given card. The size of SCR register is 64 bits. This register shall be set in the factory by the SDNAND

The following table describes the SCR register content.



Description	Field	Width	Cell Type	SCR Slice
SCR Structure	SCR_STRUCTURE	4	R	[63:60]
SD Memory Card - Spec. Version	SD_SPEC	4	R	[59:56]
DATA_STAT_AFTER_ERASE	DATA_STAT_AFTER_ERASE	1	R	[55:55]
SD Security Support	SD_SECURITY	3	R	[54:52]
DAT Bus widths supported	SD_BUS_WIDTHS	4	R	[51:48]
Reserved	-	16	R	[47:32]
Reserved for manufacturer usage	-	32	R	[31:0]

The SCR Fields

SCR_STRUCTURE	SCR structure version	SD Physical Layer Specification Version
0	SCR version No. 1.0	Version 1.01-2.00
1-15	reserved	

SCR Register Structure Version



9. Power Up

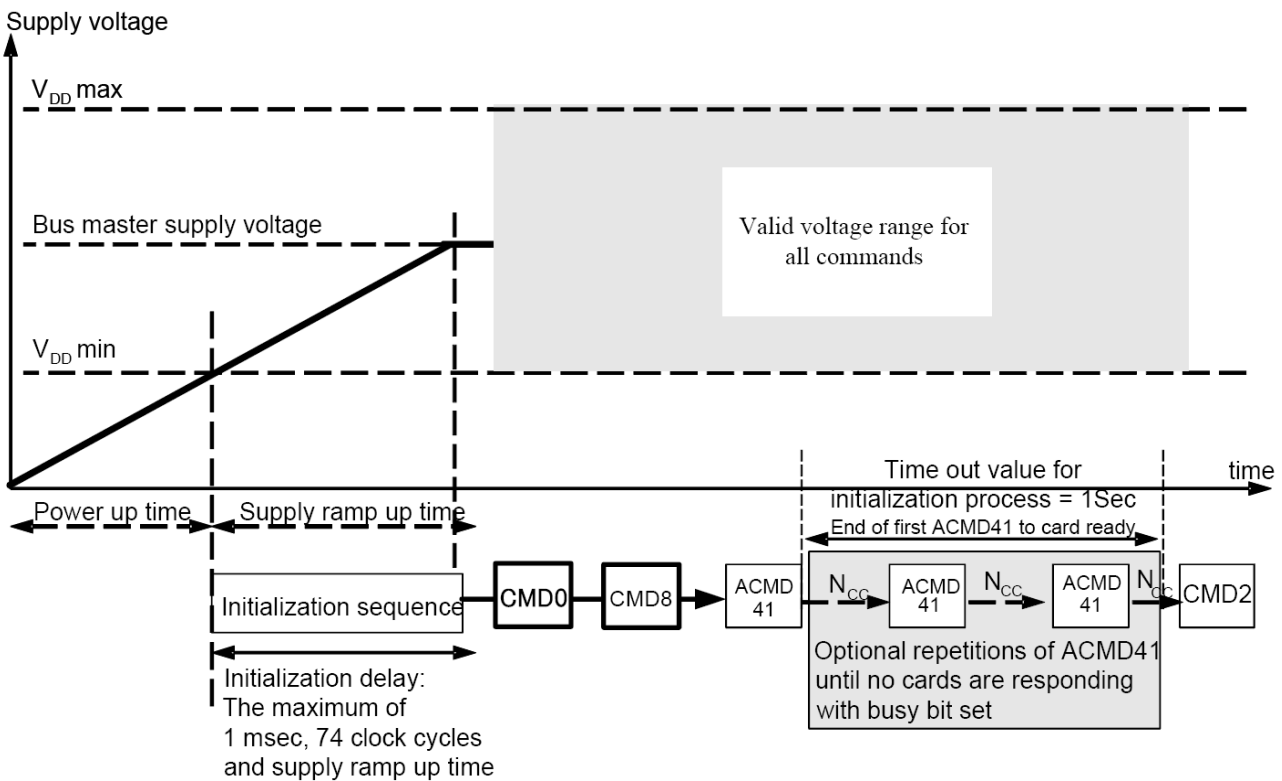

Power-up Diagram

'Power up time' is defined as voltage rising time from 0 volt to VCC min.

'Supply ramp up time' provides the time that the power is built up to the operating level (Host SupplyVoltage) and the time to wait until the SDNAND can accept the first command,

The host shall supply power to the SDNAND so that the voltage is reached to Vcc_min within 250ms and start to supply at least 74 SD clocks to the SDNAND with keeping CMD line to high.

9.2 Power Up Time

Host needs to keep power line level less than 0.5V and more than 1ms before power ramp up.

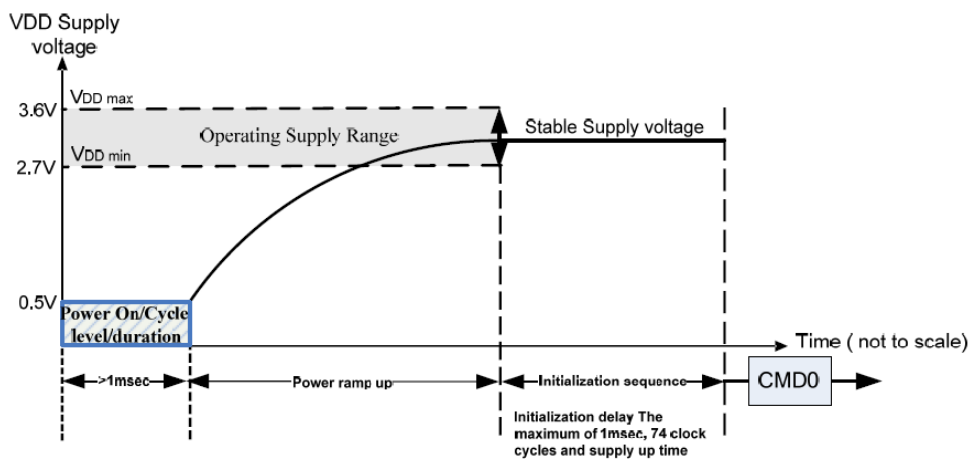

9.2.1 Power On or Power Cycle

Followings are requirements for Power on and Power cycle to assure a reliable SDNAND hard reset.

- (1) Voltage level shall be below 0.5V



(2) Duration shall be at least 1ms.

9.2.2 Power Supply Ramp Up

The power ramp up time is defined from 0.5V threshold level up to the operating supply voltage which is stable between VCC (min.) and VCC (max.) and host can supply SDCLK.

Followings are recommendation of Power ramp up:

- (1) Voltage of power ramp up should be monotonic as much as possible.
- (2) The minimum ramp up time should be 0.1ms.
- (3) The maximum ramp up time should be 35ms for 2.7-3.6V power supply.

When the host shuts down the power, the VCC shall be lowered to less than 0.5Volt for a minimum period of 1ms. During power down, DAT, CMD, and CLK should be disconnected or driven to logical 0 by the host to avoid a situation that the operating current is drawn through the signal lines.

If the host needs to change the operating voltage, a power cycle is required. Power cycle means the power is turned off and supplied again. Power cycle is also needed for accessing SDNAND that are already in Inactive State. To create a power cycle the host shall follow the power down description before power up the SDNAND (i.e. the VCC shall be once lowered to less than 0.5Volt for a minimum period of 1ms).



10. Reference Design

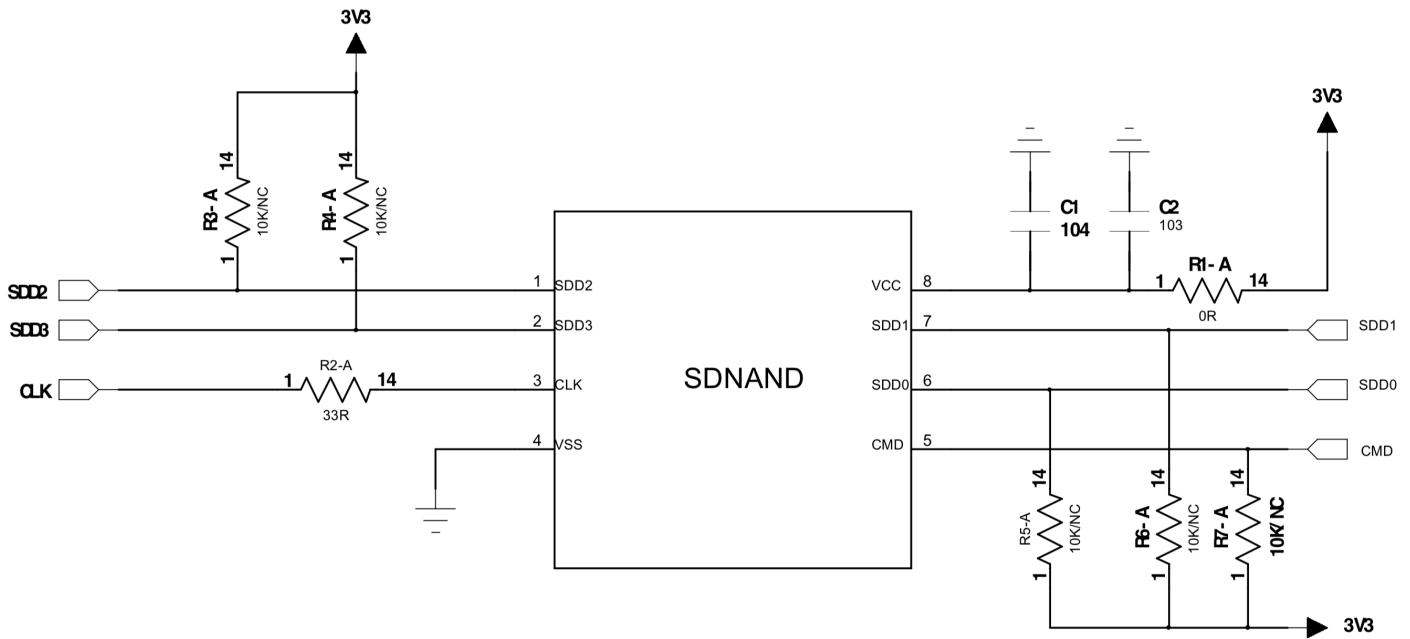

Note:

R_{DAT} and R_{CMD} (10K~100 k Ω) are pull-up resistors protecting the CMD and the DAT lines against bus floating when SDNAND is in a high-impedance mode.

The host shall pull-up all DAT0-3 lines by R_{DAT} , even if the host uses the SDNAND as 1-bit mode only in SD mode. It is recommended to have 2.2uF capacitance on VCC.

R_{CLK} reference 0~120 Ω .