

# 規格承認書

PECIFICATION FOR APPROVAL

客戶  
CUSTOMER : \_\_\_\_\_  
項目  
ITEM : 驻极体电容咪头 (ECM)  
型號  
TYPE : GMI6022-2C52DB  
描述  
DESCRIPTION :  $\phi 6.0 \times H2.2$  mm 焊点 2.0V 1033 -52 dB  $\leq 2.2K \Omega$  S/N:  $\geq 58$  dBA  
客戶料號  
CUSTOMER NO. : \_\_\_\_\_  
規格書號  
SPECIFICATION NO.: \_\_\_\_\_  
版本  
EDITION NO. : V1.1  
日期  
DATE : 2020-1-9

## 客戶承認

### CUSTOMER CONFIRM AND SIGN

檢查 TESTED BY	審核 CHECKED BY	承認 APPROVED BY

## 東莞市贏海電子有限公司

### DONGUAN INGHAI ELECTRONICS CO.,LTD

製作 ISSUED BY	審查 CHECKED BY	確認 APPROVED BY
周明	刘承成	

地址：广东省东莞市虎门镇怀德社区雅瑶工业区旧村二巷一号 2~4F

電話 / TEL: 0769-83060958 傳真 / FAX: 0769-81608993

網址: HTTP://WWW.INGHAI.COM

## A. SCOPE

This specification applies electret condenser microphone, GMI6022-2C52DB

## B. SPECIFICATION

■ Test condition:  $R_L=2.2K\Omega$   $V_S=2.0V$   $TEMP=20^{\circ}C\pm 2^{\circ}C$  Related humidity= $65\pm 5\%$

No.	Item	Symbol	Unit	Specification	Condition
1	Directivity			Omnidirectional	
2	Sensitivity	<b>S</b>	dB	-52±3	f=1KHz, 1Pa 0dB=1V/Pa
3	Standard operating voltage	<b>Vs</b>	V	2.0	
4	Output impedance	<b>Zout</b>	K $\Omega$	≤2.2	f=1KHz, 1Pa
5	Frequency		Hz	100-10,000	
6	Max operating voltage		V .	10	
7	Sensitivity reduction	$\Delta$ <b>S-Vs</b>	dB	-3	f=1KHz, 1Pa Vs=1.5VDC to 3VDC
8	Max. current consumption	<b>IDSS</b>	mA	≤0.5	
9	Signal to noise ration	<b>S/N</b>	dBA	≥58	f=1KHz, P in=1Pa
10	Max input sound level	<b>SPL</b>	dB	110	
11	Operation temp.		°C	-30 ~+70	
12	Storage temp.		°C	-40 ~+85	
13	Dimension		mm	$\phi$ 6.0 x H2.2	See appearance drawing
14	Terminal			Terminal	See appearance drawing

### C. TYPICAL FREQUENCY RESPONSE CURVE

全指向性



### D. APPEARANCE DRAWING



### E. MEASUREMENT CIRCUIT

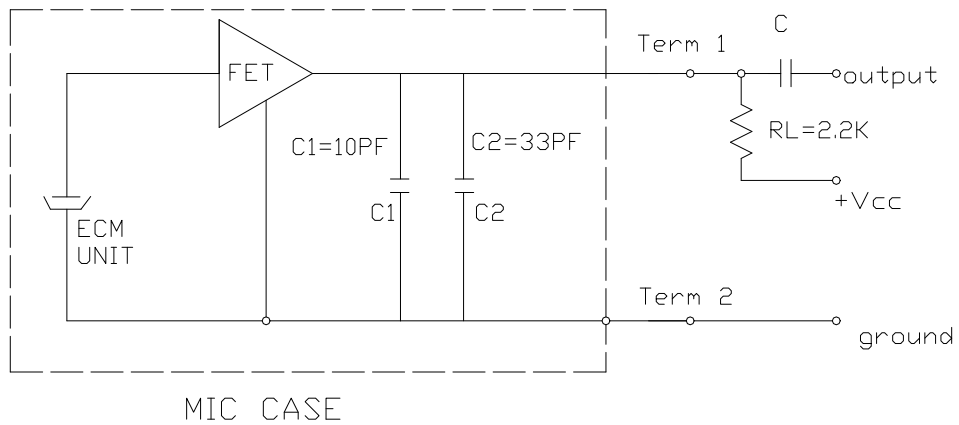

## F. Explode Drawing



NO.	PARTS
1	PCB
2	Film(FEP)
3	Holder
4	Spacer
5	Outer most shell(Al)
6	Protection fleece
7	FET
8	Electronic line
9	Capacitance

<b>G. 可靠性试验 Reliability Test</b>	
经过以下所有试验在 20℃ 的条件下放置 3 小时后,麦克风的灵敏度与试验前比较变化在 3dB 以内 After any following tests, the sensitivity of the microphone to be within $\pm 3\text{dB}$ of initial sensitivity after 3hours of conditioning at 20℃	
5-1 振动试验 Vibration	周波数 1/Frequency1:10Hz~55Hz 振幅/Amplitude:1.52mm 变化/Change of Frequency:1 octave/min 3 方向,各 2 小时/hours in each of 3 axes
5-2 高温试验 Dry Heat	+80 $\pm$ 5℃ for 96 hours
5-3 低温试验 Dry Cold	-40 $\pm$ 5℃ for 96 hours
5-4 高温高湿试验 Damp Heat	90%~95%RH, +60 $\pm$ 5℃ for 96 hours
5-5 温度循环试验 Temperature cycles	-20℃ $\longleftrightarrow$ 25℃ $\longleftrightarrow$ 70℃ (2h) (1h) (2h) (1h) (2h) $\times$ 10 cycles
5-6 跌落试验 Packing drop test	Height:1m 顺序:三个面各跌 10 次 Procedure:10 times from each of 3 axes
5-7 温度冲击试验 Temperature impact test	-20℃ $\longleftrightarrow$ 70℃ 30min 30s 30min $\times$ 10 cycles
5-8 静电冲击试验 Electrostatic shock test	6000V(contact), 15000V(air) $\times$ 10 axes
备注 Note	
6-1 工作温度范围 Operation Temperature	-30℃~70℃
6-2 储存温度范围 Storage Temperature	-40℃~85℃
<b>H. 焊接条件 Soldering Condition</b>	
7-1 焊接使用 90W 的烙铁。 The soldering copper of a type of 90W shall be applied	
焊接条件 Soldering Condition.	
7-2 电烙铁表面温度 320 $\pm$ 10℃ The temperature of the working surface of the soldering copper shall be 320 $\pm$ 10℃	
7-3 焊接时把麦克风嵌入散热能力强的金属块内。	

ECM shall be soldered fixed on the metal block(heat sink)which has the higher radiation effects said heat sink

Shall contact with of ECM.

7-4 焊接时间控制在 2~3 秒内。

time for each terminal shall be 2~3 sec.

7-5 焊接后不能出现针孔。

The pinhole after soldering shall be avoided.

7-6 静电容易破坏麦克风必须采取措施避免（电烙铁接地，戴静电环等。）

ECM may easily destroyed by the static electricity and the countermeasure for eliminating the static electricity (the ground for soldering copper, for worktable and for human body) shall be executed.

7-7 散热板形状 Shape of heat sink



7-8 固定部孔形状 Shape of hole at fixed part

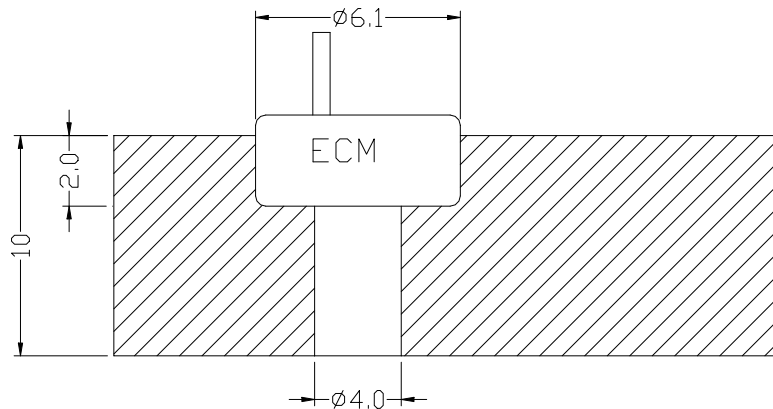

unit:mm