

YTS-E004-X系列

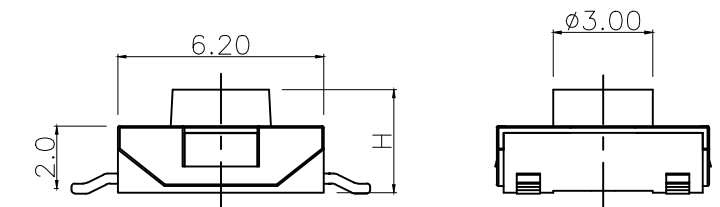

H	
2.5	3.1
3.4	4.3

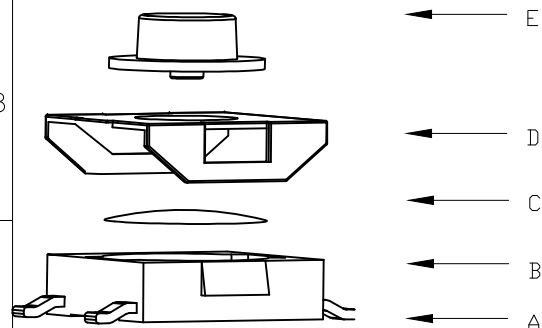
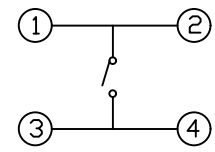

电路图
CIRCUIT DIAGRAM

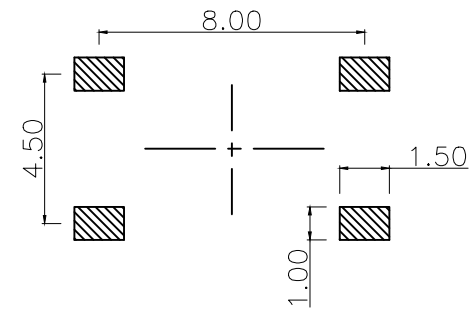
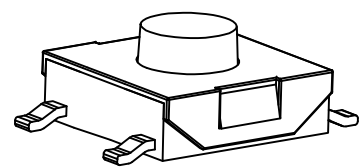
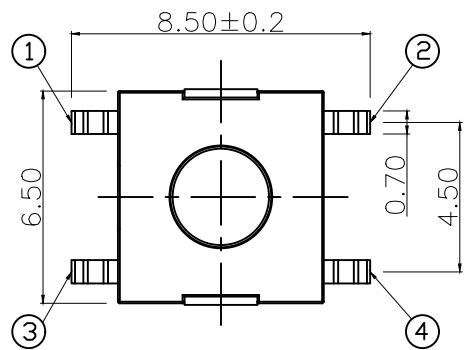

PCB. 焊接图
PCB. WELDING DRAWING

主要技术参数、性能

The Main Thchnology Performance

额定电流、电压 Rate voltage. current	50mA DC12V
接触电阻 Contact resistance	≤100mΩ
按力 Operating force	见编码表
行程 travel	0.25±0.1mm
绝缘电阻 Insulated resistance	≥100MΩ
介电强度 Dielectric strength	≥250VAC/1min
寿命 Endurance	≥100000次

编码表

YTS	E004	X	XXX	XX	XX	X
开关	型号	等级	高度	克力	另码	包装
		A034	034 (3.4mm)	25 (250g)	16(160gf)	01B 1000
		A043	043 (4.3mm)	25 (250g)	16(160gf)	01B 1000
		B031	031 (3.1mm)	25 (250g)	16(160gf)	01B 1500

项目 ITEM	名称 DESCRIPTION	材质 MATERIAL	数量 QTY	表面处理/颜色 FINSH/COLOR
E	按钮	PPA	1	红色
D	盖板	铜盖板	1	镀铜锡
C	弹片	不锈钢	1	镀银
B	本体	PPA	1	黑色
A	卡件	黄铜	1	镀银

标记 SING	处数 FREQUENCY	更改文件号 REVISION	签名 APPROVED	日期 DATE	比例 SCALE	1:1	一般公差 GENERAL TOLERANCE
设计 DESIGN		赵晓峰		2017.05.17	单位 UNIT	mm	0.5~2 ±0.10
审核 CHECKED		陈乐峰		2017.05.17	重量 WEIGHT		2~5 ±0.25
批准 APPROVED		朱旭静		2017.05.17			5~10 ±0.30
							角度 ANGLE ±0.5°

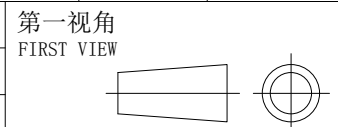

名称/NAME:
**轻触开关
TACTILE SWITCH**

型号/MODEL:
YTS-E004-X系列

东莞市博众电气有限公司
DONGGUAN BOZHONG ELECTRONIC CO.,LTD.