

## Evaluating the **AD7403** 16-Bit, Isolated Sigma-Delta ADC

### FEATURES

**Full featured evaluation board for the [AD7403](#)**  
**On-board power supplies**  
**Standalone capability**  
**System demonstration platform high speed (SDP-H1) controller board compatible, [EVAL-SDP-CH1Z](#)**  
**PC software for control and data analysis**

### EVALUATION KIT CONTENTS

**[EVAL-AD7403FMCZ](#) evaluation board**  
**CD containing evaluation software for the [AD7403](#)**

### ADDITIONAL EQUIPMENT NEEDED

**[EVAL-SDP-CH1Z](#), includes a USB cable and 12 V wall wart**  
**Signal source**  
**PC running Windows XP SP3, Windows Vista, or Windows 7 with USB 2.0 port**

### ONLINE RESOURCES

#### Documents Needed

[AD7403](#) data sheet  
[EVAL-AD7403FMCZ](#) user guide

#### Required Software

[EVAL-AD7403FMCZ](#) evaluation software  
[FAQs and Troubleshooting](#)

### GENERAL DESCRIPTION

The [EVAL-AD7403FMCZ](#) is a full featured evaluation board designed to allow the user to easily evaluate all features of the [AD7403](#) isolated analog-to-digital converter (ADC). The evaluation board can be controlled by the [EVAL-SDP-CH1Z](#) via the FMCZ connector (J9). The SDP-H1 board ([EVAL-SDP-CH1Z](#)) allows the evaluation board to be controlled through a USB port of a PC using the evaluation board software, which is available for download from the [EVAL-AD7403FMCZ](#) product page or from the installer CD included in the evaluation board kit.

On-board components include the following:

[ADuM6000](#): isolated iCoupler® 5 kV, dc-to-dc converter  
[ADP2441](#): 36 V, 1 A, synchronous, step-down dc-to-dc regulator  
[ADP7104ARDZ-5.0](#): 5 V low noise LDO

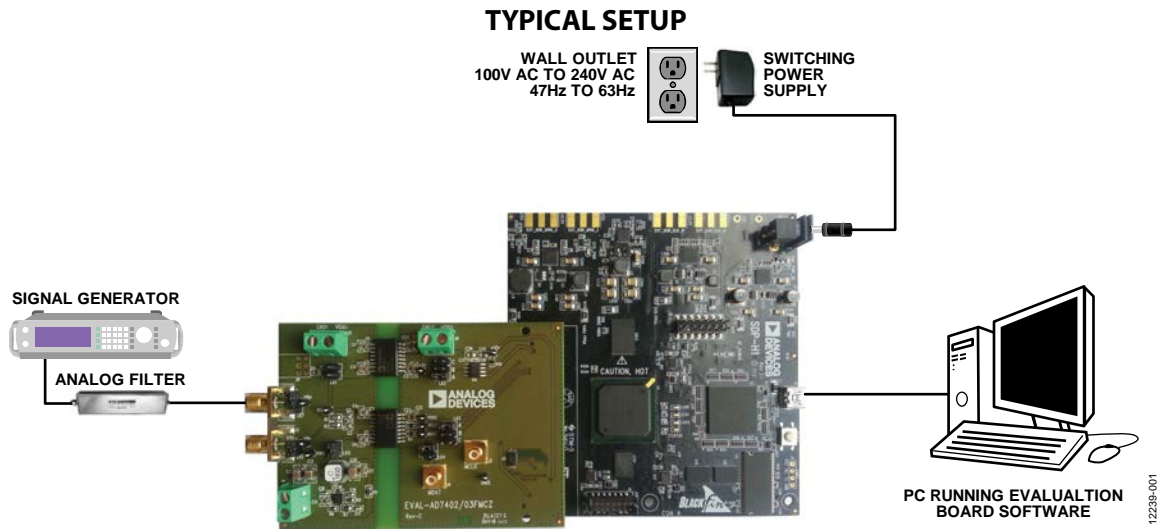

Figure 1. Typical Setup ([EVAL-AD7403FMCZ](#) on Left and [EVAL-SDP-CH1Z](#) on Right)

**TABLE OF CONTENTS**

Features .....	1	Setup Conditions.....	9
Evaluation Kit Contents.....	1	Evaluation Board Circuitry .....	10
Additional Equipment Needed .....	1	Sockets/Connectors .....	10
Online Resources .....	1	Test Points .....	10
General Description .....	1	How to Use the Software .....	11
Typical Setup .....	1	Starting the Software.....	11
Revision History .....	2	Setting Up the System for Data Capture .....	11
Getting Started .....	3	Overview of the Main Window .....	13
Quick Start Steps .....	3	Generating a Waveform Analysis Report.....	14
Software Installation Procedures.....	4	Generating a Histogram of the ADC Code Distribution .....	15
Evaluation Board Setup Procedures.....	6	Generating a Fast Fourier Transform of AC Characteristics.....	16
Evaluation Board Hardware .....	7	Generating a Summary of the Waveform, Histogram, and	
AD7403 Description .....	7	Fast Fourier Transform.....	17
Power Supplies .....	7	Saving Files.....	18
Input Signals.....	7	Printing a Screenshot.....	18
Link Configuration Options .....	9	Opening Files.....	18

**REVISION HISTORY**

5/14—Revision 0: Initial Version

## GETTING STARTED

### QUICK START STEPS

Follow these steps to quickly evaluate the [AD7403](#) ADC:

1. Install the evaluation software from the [AD7403](#) product page or from the CD included in the [EVAL-AD7403FMCZ](#) evaluation board kit. Ensure that the [EVAL-SDP-CH1Z](#) board is disconnected from the USB port of the PC while installing the software. (The PC may need to be restarted after the installation)
2. Ensure that the various link options are configured as outlined in Table 2.
3. Connect the [EVAL-SDP-CH1Z](#) board to the evaluation board as shown in Figure 2.
4. Connect the [EVAL-SDP-CH1Z](#) board to the PC via the USB cable. For Windows® XP, you may need to search for the [EVAL-SDP-CH1Z](#) drivers. Choose to automatically search for the drivers for the [EVAL-SDP-CH1Z](#) board if prompted by the operating system.
5. Power up the [EVAL-SDP-CH1Z](#) by inserting the 12 V dc barrel jack (included with the [EVAL-SDP-CH1Z](#)) into the barrel connector labeled +12V\_VIN on the [EVAL-SDP-CH1Z](#).
6. Launch the evaluation software from the **Analog Devices** subfolder in the **Programs** menu.
7. Connect an input signal via the VIN+, J1 connector.



Figure 2. [EVAL-AD7403FMCZ](#) Evaluation Board (Left) Connected to the [EVAL-SDP-CH1Z](#) Board (Right)

**SOFTWARE INSTALLATION PROCEDURES**

The EVAL-AD7403FMCZ evaluation kit includes a CD containing evaluation software to be installed on your PC before you begin using the evaluation board.

There are two parts to the installation:

- EVAL-AD7403FMCZ evaluation software installation
- EVAL-SDP-CH1Z driver installation

**Warning**

The evaluation board software and drivers must be installed before connecting the evaluation board and EVAL-SDP-CH1Z board to the USB port of the PC to ensure that the evaluation system is correctly recognized when it is connected to the PC.

**Installing the EVAL-AD7403FMCZ Evaluation Board Software**

To install the EVAL-AD7403FMCZ evaluation board software,

1. Insert the included evaluation software installation CD into the CD drive of a Windows-based PC, and open the contents of the CD.
2. Double-click the **setup.exe** file to begin the installation. By default, the software is saved to the following location: **C:\Program Files\Analog Devices\AD7403\**
3. A dialog box appears asking for permission to allow the program to make changes to your computer. Click **Yes** to begin the installation process.

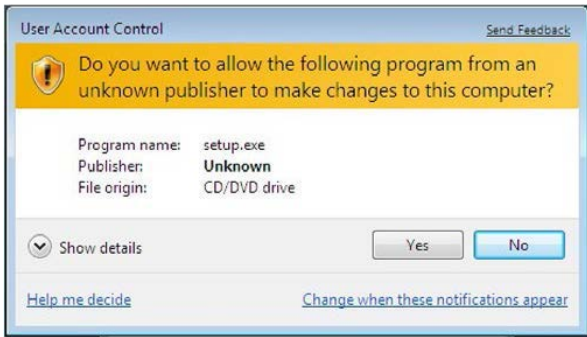

Figure 3. Evaluation Software Installation—User Account Control

4. Select the location to install the software, and then click **Next**.

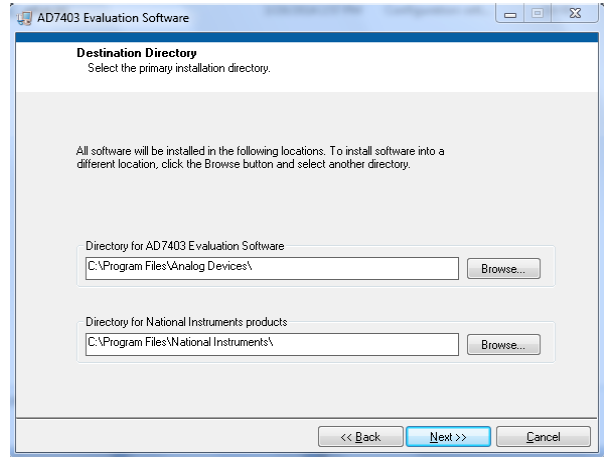

Figure 4. Evaluation Software Installation—Destination Directory

5. A license agreement appears. Read the agreement, and then select **I accept the License Agreement** and click **Next**.

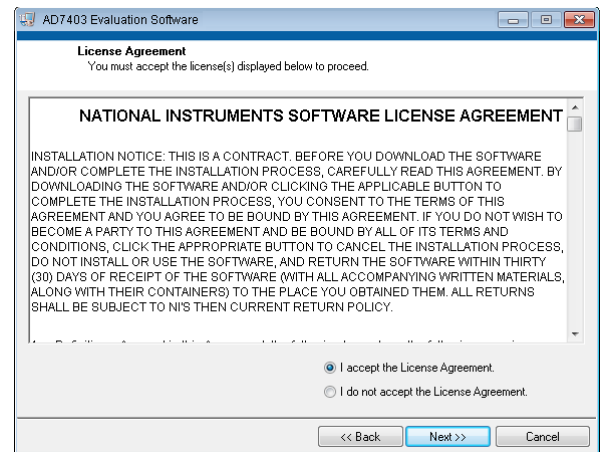

Figure 5. Evaluation Software Installation—Accepting the License Agreement

6. A summary of the installation is displayed. Click **Next** to continue.

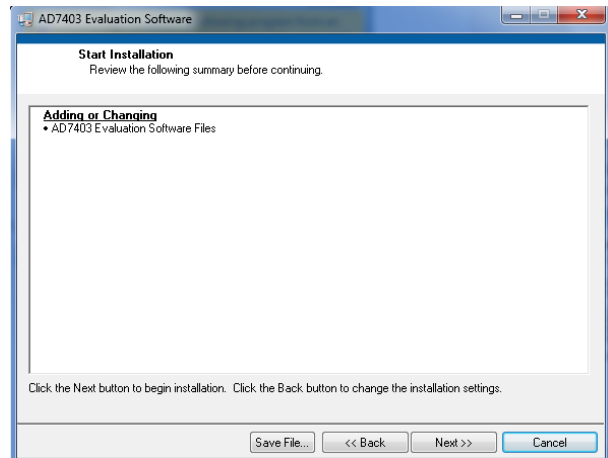

Figure 6. Evaluation Software Installation—Start Installation

7. A dialog box informs you when the evaluation software installation is complete. Click **Next** to proceed with the installation of the drivers.

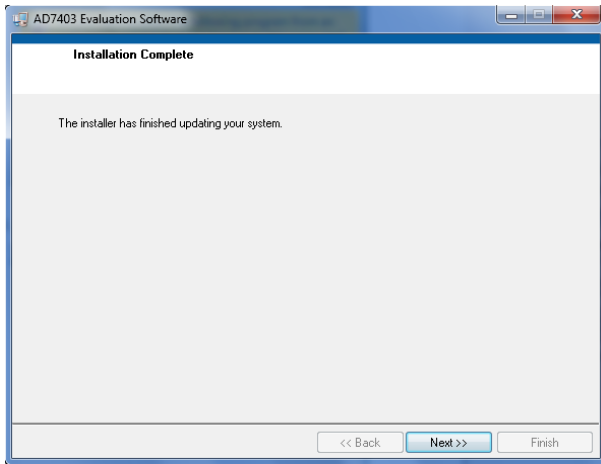

Figure 7. Evaluation Software Installation—Installation Complete

**Installing the EVAL-SDP-CH1Z System Demonstration Platform Board Drivers**

After the installation of the evaluation board software is complete, the **ADI SDP Drivers Setup** wizard window opens for the installation of the **EVAL-SDP-CH1Z** system demonstration platform board drivers.

1. Make sure that all other applications are closed, and then click **Next** to begin the driver installation process.

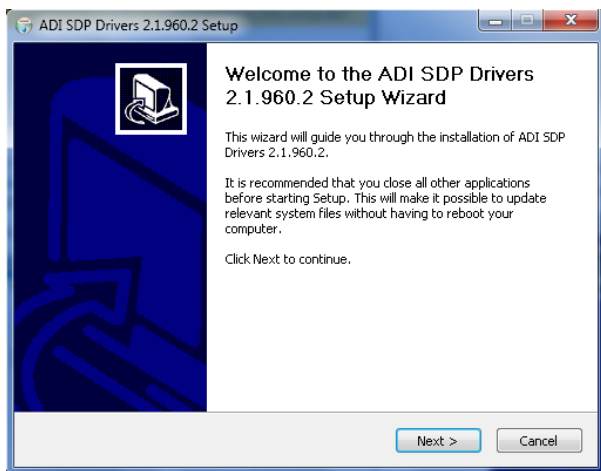

Figure 8. EVAL-SDP-CH1Z Drivers Installation—Setup Wizard

2. Select the location to install the drivers, and then click **Install**.

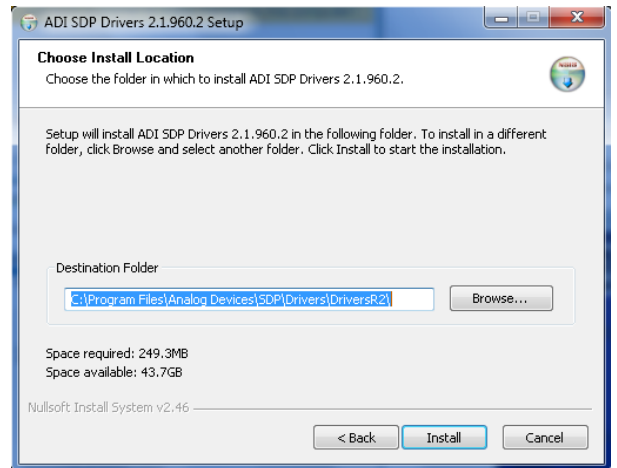

Figure 9. EVAL-SDP-CH1Z Drivers Installation—Choose Install Location

3. Click **Install** to proceed with the installation.

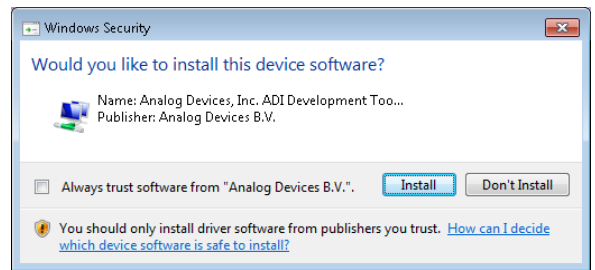

Figure 10. EVAL-SDP-CH1Z Drivers Installation—Windows Security

4. To complete the drivers installation, click **Finish**, which closes the installation wizard.

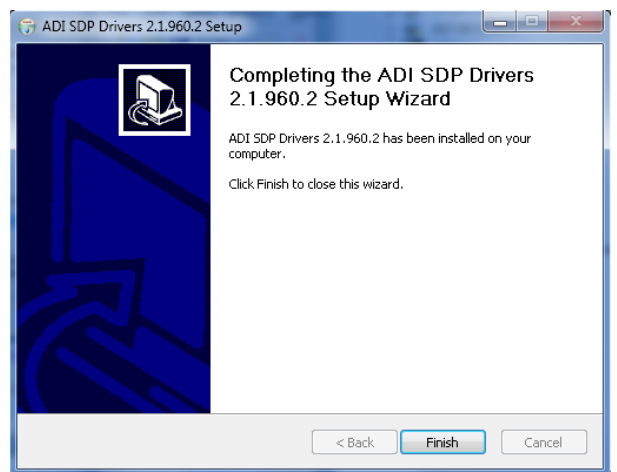

Figure 11. EVAL-SDP-CH1Z Drivers Installation—Complete

## EVALUATION BOARD SETUP PROCEDURES

The [EVAL-AD7403FMCZ](#) connects to the [EVAL-SDP-CH1Z](#) system demonstration platform. The [EVAL-SDP-CH1Z](#) board is the controller board, which is the communication link between the PC and the main evaluation board. Figure 2 shows a photograph of the connections between the [EVAL-AD7403FMCZ](#) daughter board and the [EVAL-SDP-CH1Z](#) board.

After following the instructions in the Software Installation Procedures section, set up the evaluation and SDP-H1 boards as detailed in this section.

### Warning

The evaluation software and drivers must be installed before connecting the evaluation board and [EVAL-SDP-CH1Z](#) board to the USB port of the PC to ensure that the evaluation system is correctly recognized when it is connected to the PC.

### Connecting the Evaluation and SDP Boards to a PC

1. Ensure that all configuration links are in the appropriate positions (see Table 2).
2. Connect the [EVAL-AD7403FMCZ](#) board securely to the J4 FMC connector on the [EVAL-SDP-CH1Z](#) board.
3. The [EVAL-SDP-CH1Z](#) board requires an external power supply adapter, which is included in the [EVAL-SDP-CH1Z](#) kit. Connect this power supply to the dc barrel connector labeled +12V\_VIN on the [EVAL-SDP-CH1Z](#) board.
4. Connect the [EVAL-SDP-CH1Z](#) board to the PC via the USB cable enclosed in the [EVAL-SDP-CH1Z](#) kit.

### Verifying the Board Connection

1. Allow the **Found New Hardware Wizard** to run after the [EVAL-SDP-CH1Z](#) board is plugged into your PC. (If you are using Windows XP, you may need to search for the [EVAL-SDP-CH1Z](#) drivers. Choose to automatically search for the drivers for the [EVAL-SDP-CH1Z](#) board if prompted by the operating system.)
2. Check that the board is connected to the PC correctly using the **Device Manager** of the PC.
  - a. Access the **Device Manager** as follows:
    - i. Right-click **My Computer** and then click **Manage**.
    - ii. A dialog box appears asking for permission to allow the program to make changes to your computer. Click **Yes**.
    - iii. The **Computer Management** box appears. From the list of **System Tools**, click **Device Manager**.
  - b. Under **ADI Development Tools**, **Analog Devices SDP-H1** should appear (see Figure 12), indicating that the [EVAL-SDP-CH1Z](#) driver software is installed and that the board is connected to the PC correctly.

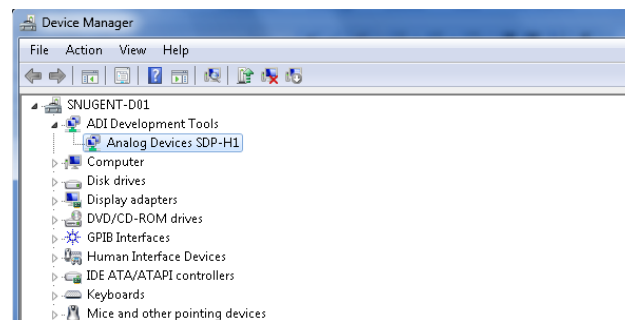

Figure 12. Device Manager:  
Checking that the Board Is Connected to the PC Correctly

### Disconnecting the [EVAL-AD7403FMCZ](#) Board

#### Caution

Always remove power from the [EVAL-SDP-CH1Z](#) or click the reset tact switch (located alongside the mini-USB port) before removing the [EVAL-AD7403FMCZ](#) daughter board.



## EVALUATION BOARD HARDWARE

### AD7403 DESCRIPTION

This user guide describes the evaluation board for the [AD7403](#) isolated ADC. The [AD7403](#) is a second-order,  $\Sigma$ - $\Delta$  modulator that converts an analog input signal into a high speed, 1-bit data stream with on-chip digital isolation based on Analog Devices, Inc., *iCoupler* technology. The [AD7403](#) operates from a 5 V ( $V_{DD1}$ ) power supply and accepts a differential input signal of  $\pm 250$  mV ( $\pm 320$  mV full scale). The differential input is ideally suited to shunt voltage monitoring in high voltage applications where galvanic isolation is required.

The analog input is continuously sampled by a high performance analog modulator and converted to a ones density, digital output stream with a data rate of up to 20 MHz. The original information can be reconstructed with an appropriate digital filter. The serial I/O can use a 5 V or a 3.3 V supply ( $V_{DD2}$ ).

The serial interface is digitally isolated. High speed CMOS, combined with monolithic transformer technology, allows the on-chip isolation to provide outstanding performance characteristics that are superior to the performance of alternatives, such as optocoupler devices. The [AD7403](#) device is offered in a 16-lead, wide-body SOIC package and has an operating temperature range of  $-40^{\circ}\text{C}$  to  $+125^{\circ}\text{C}$ .

Complete specifications for the [AD7403](#) device are provided in the [AD7403](#) data sheet and should be consulted in conjunction with this user guide when using the evaluation board. Full details on the [EVAL-SDP-CH1Z](#) are available on the [SDP-H1](#) product page.

### POWER SUPPLIES

Care should be taken before applying power and signals to the evaluation board to ensure that all link positions are set according to the required operating mode. See Table 2 for the complete list of link options.

This evaluation board is designed to be supplied via the [EVAL-SDP-CH1Z](#). The [EVAL-SDP-CH1Z](#) generates 12 V and 3.3 V

supply rails. The 12 V supply is connected to the on-board 5 V linear regulator that supplies the [ADuM6000](#) with power. The [ADuM6000](#) generates an isolated 5 V supply to power the  $V_{DD1}$  rail of the [AD7403](#). The 3.3 V supply rail from the [EVAL-SDP-CH1Z](#) is used to supply the  $V_{DD2}$  rail of the [AD7403](#).

If the user wishes to supply  $V_{DD1}$  externally, an external power supply in the range of  $24\text{ V} \pm 5\%$  can be connected to the HIGH\_V connector, J7. Alternatively, an external supply in the range of  $5\text{ V} \pm 10\%$  can be connected to the J5 connector.

The  $V_{DD2}$  supply can also be supplied via an external power supply in the range of 3 V to 5.5 V via the J6 connector.

There are two main ground planes: GND1 and GND2. These planes are isolated with a creepage and clearance of 8 mm.

### Caution

When the [EVAL-AD7403FMCZ](#) is connected to the [EVAL-SDP-CH1Z](#), care must be taken to ensure that if an external voltage is supplied to the J6 input connector, the voltage does not exceed 3.3 V. Exceeding this voltage may cause permanent damage to the [EVAL-SDP-CH1Z](#) board.

### INPUT SIGNALS

The analog input range to the [AD7403](#) is  $\pm 250$  mV ( $\pm 320$  mV full scale), which should not be exceeded. An input signal in the range of 500 mV p-p should be connected to the evaluation board via the analog input connector, J1.

The [EVAL-AD7403FMCZ](#) has analog and digital ground planes that are physically isolated from one other. As such, power to the analog supply rail is by default, supplied through the on-board [ADuM6000](#) isolated *iCoupler* 5 kV, dc-to-dc converter.  $V_{DD1}$  can optionally be supplied from the J5 external connector or from the J7 high voltage external connector. A 24 V supply connected to J7 is stepped down to 5 V by means of the on-board [ADP2441](#) step-down dc-to-dc regulator. See Table 2 for more information about supplying  $V_{DD1}$  externally.

**Table 1. External Power Supplies (Optional)**

Power Supply	Connector	Voltage Range	Purpose
$V_{DD1}$	J5	$5\text{ V} \pm 10\%$	Analog supply rail
$V_{DD2}$	J6	3 V to 5.5 V	Digital supply rail without <a href="#">EVAL-SDP-CH1Z</a> connected
		$3.3\text{ V} \pm 5\%$	Digital supply rail with <a href="#">EVAL-SDP-CH1Z</a> connected
HIGH_V	J7	$24\text{ V} \pm 5\%$	Analog supply rail (high voltage alternative to J5)

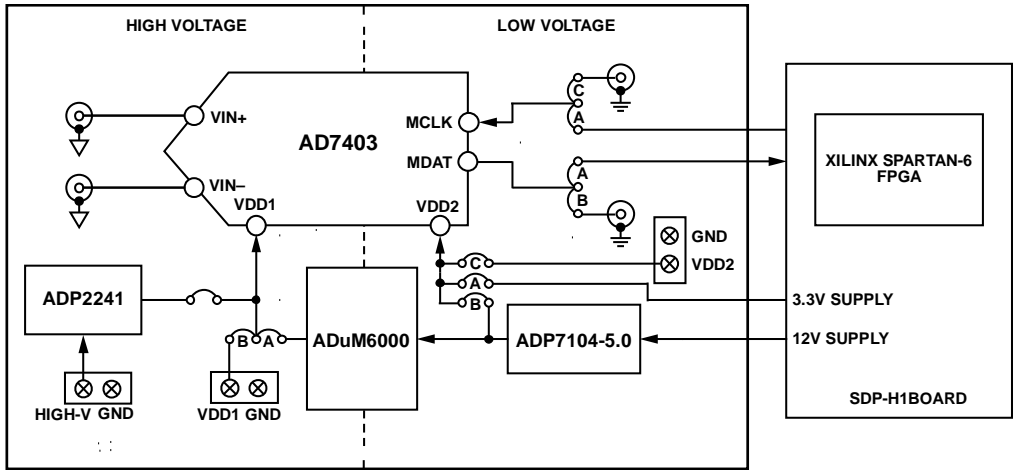

Figure 13. EVAL-AD7403FMCZ Block Diagram

12238-101



## LINK CONFIGURATION OPTIONS

There are multiple link options that must be set correctly to select the appropriate operating setup before you begin using the evaluation board. The functions of these options are outlined in Table 2.

### SETUP CONDITIONS

Care should be taken before applying power and signals to the evaluation board to ensure that all link positions are as required by the operating mode. There are two modes in which to operate the evaluation board. The evaluation board can be operated in

SDP-H1 controlled mode to be used with the the [EVAL-SDP-CH1Z](#) board, or the evaluation board can be used in standalone mode.

The Default Position column of Table 2 shows the default positions in which the links are set when the evaluation board is packaged. When the board is shipped, it is set up to operate in SDP-H1 controlled mode, with the power supplied from the [EVAL-SDP-CH1Z](#) board and the analog supply rail ( $V_{DD1}$ ) being supplied via the on-board *isoPower*® [ADuM6000](#) dc-to-dc converter.

**Table 2. Link Options**

Category	Link	Default Position	Function
Power Supplies	LK1	A	This link selects the <a href="#">AD7403</a> $V_{DD1}$ supply source. Remove LK5 if using either Position A or Position B. Position A: $V_{DD1}$ is supplied from the <a href="#">ADuM6000</a> on-board device. Position B: $V_{DD1}$ is supplied externally via Connector J5.
	LK5	Removed	When LK5 is inserted, $V_{DD1}$ is supplied via a step-down dc-to-dc regulator via J7. Remove LK5 if $V_{DD1}$ is supplied via LK1.
	LK2	A	This link selects the <a href="#">AD7403</a> $V_{DD2}$ supply source. Position A: $V_{DD2}$ is supplied from the <a href="#">EVAL-SDP-CH1Z</a> board. Position B: $V_{DD2}$ is supplied from the on-board 5 V regulator. Position C: $V_{DD2}$ is supplied externally via Connector J6.
Analog Input	LK7	Removed	When LK7 is inserted, AIN+ is shorted to ground. Remove LK7 if a signal is applied to AIN+.
	LK8	Inserted	When LK8 is inserted, AIN- is shorted to ground. Remove LK8 if a signal is applied to AIN-.
Serial Interface	LK3	A	This link is used to select the MCLK source for the serial interface. Position A: MCLK is sourced from the <a href="#">EVAL-SDP-CH1Z</a> board. Position B: Do not use. Position C: MCLK is sourced from the J3 SMB jack. (Standalone mode.)
	LK4	A	This link is used to route the MDAT output for the serial interface. Position A: MDAT is sent to the <a href="#">EVAL-SDP-CH1Z</a> board. Position B: MDAT is sent to the J4 SMB jack. (Standalone mode.)

## EVALUATION BOARD CIRCUITRY

### SOCKETS/CONNECTORS

The connectors and sockets on the [EVAL-AD7403FMCZ](#) are described in Table 3.

**Table 3. On-Board Connectors**

Connector	Function
J1	Analog input AIN+
J2	Analog input AIN-
J3	MCLK input—standalone mode
J4	MDAT output—standalone mode
J5	V <sub>DD1</sub> external source
J6	V <sub>DD2</sub> external source
J7	V <sub>DD1</sub> external source—high voltage

The default interface to this evaluation board is via the FMC connector, which connects the [EVAL-AD7403FMCZ](#) to the [EVAL-SDP-CH1Z](#) board. If the [EVAL-AD7403FMCZ](#) board is used in standalone mode, communication is achieved via the J3 and J4 SMB jacks. See Table 2 for more information about configuring the evaluation board for standalone mode.

### TEST POINTS

There are several test points on the [EVAL-AD7403FMCZ](#) board. These test points provide easy access to the signals from the evaluation board for probing, evaluation, and debugging.

## HOW TO USE THE SOFTWARE

### STARTING THE SOFTWARE

After the [EVAL-AD7403FMCZ](#) and [EVAL-SDP-CH1Z](#) boards are correctly connected to your PC, the evaluation software can be started.

1. From the **Start** menu, select **Programs > Analog Devices > AD7403**. The main window of the software then opens (see Figure 15).
2. If the [EVAL-AD7403FMCZ](#) evaluation board is not connected to the USB port via the [EVAL-SDP-CH1Z](#) when the software is launched, a connectivity error displays (see Figure 14). Connect the evaluation system to the USB port of the PC and wait a few seconds, and then click **Rescan** and follow the instructions.

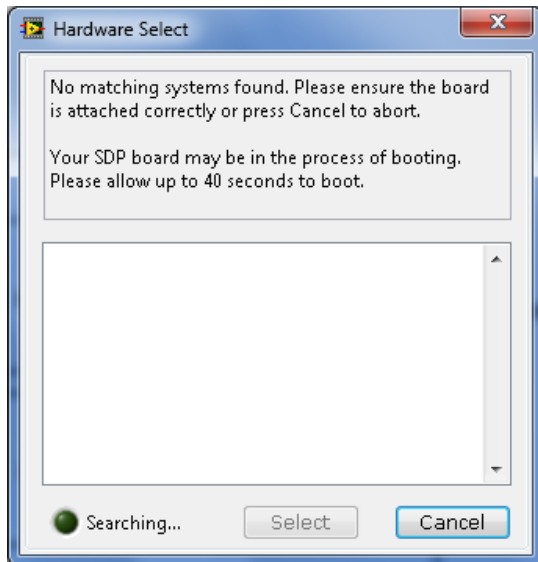

Figure 14. Connectivity Error Alert

### SETTING UP THE SYSTEM FOR DATA CAPTURE

After completing the steps in the Software Installation Procedures and Evaluation Board Setup Procedures sections, set up the system for data capture as follows:

1. Select the appropriate **FPGA Settings**.
2. Click **Single Capture** or **Continuous Capture**.

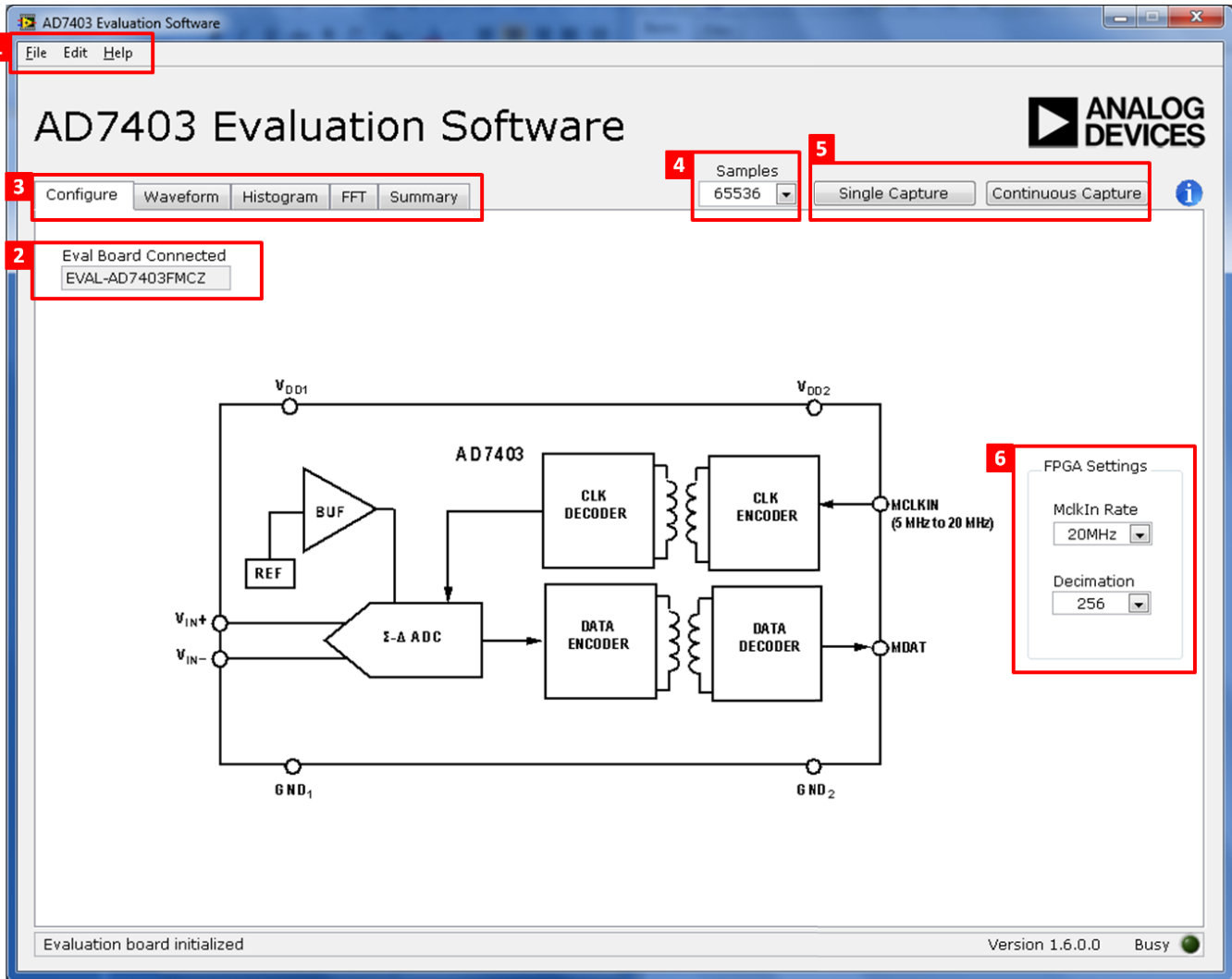

Figure 15. Evaluation Software Main Window

12239-013

## OVERVIEW OF THE MAIN WINDOW

The main window of the software is shown in Figure 15 and has the features described in this section. These features include the following:

- Menu bar
- Control buttons
- FPGA configuration options
- Data capture display
- AC/DC analysis

### Menu Bar

The menu bar (labeled 1 in Figure 15) consists of the **File**, **Edit**, and **Help** menus.

### File Menu

The **File** menu offers the following options:

- **Save Captured Data:** save captured data in comma separated values (.csv) format for future analysis.
- **Load Captured Data:** load previously captured data in .csv format for analysis.
- **Take Screenshot:** save a screenshot of the window as a .jpeg file.
- **Print Screenshot:** print a screenshot of the window to the default printer.
- **Exit:** close the application.

### Edit Menu

The **Edit** menu offers the following option:

- **Reinitialize to default:** place the evaluation board in a known default state.

### Help Menu

The **Help** menu offers the following options:

- **Analog Devices Website:** open the Analog Devices website in the default browser.
- **Context Help:** turn on context-sensitive help.
- **About:** provide evaluation kit information.

## Control Buttons, Drop-Down Boxes, and Indicators

The evaluation software includes the following control buttons, drop-down boxes, and indicators:

- The **Eval Board Connected** box (labeled 2 in Figure 15) indicates whether the **EVAL-AD7403FMCZ** board has been detected.
- The **FPGA Settings** section (labeled 6 in Figure 15) specifies the MCLK frequency used for the serial interface and the decimation ratio used by the FPGA to filter the data.
- The **Samples** drop-down box (labeled 4 in Figure 15) allows selecting the number of samples to be captured in a single acquisition.
- Clicking **Single Capture** (see label 5 in Figure 15) initiates the sampling and readback of the number of measurements defined in the **Samples** box.
- Clicking **Continuous Capture** (see label 5 in Figure 15) performs a continuous capture from the ADC. Clicking **Continuous Capture** a second time stops sampling.

## Window Tabs

There are five tabs available in the tabs area (labeled 3 in Figure 15) of the main window: **Configure**, **Waveform**, **Histogram**, **FFT**, and **Summary**. These tabs are used to switch among device configuration, waveform analysis, histogram analysis, FFT analysis, and a summary of the last capture.

Each tab is described in more detail in the *Generating a Waveform Analysis Report*; *Generating a Histogram of the ADC Code Distribution*; *Generating a Fast Fourier Transform of AC Characteristics*; and *Generating a Summary of the Waveform, Histogram, and Fast Fourier Transform sections*.

## Graph Tools

Graph tools are provided within each tab to allow you to control the cursor, zooming, and panning (see Figure 16) within the graphs displayed.



1. USED FOR CONTROLLING THE CURSOR, IF PRESENT.
2. USED FOR ZOOMING IN AND OUT.
3. USED FOR PANNING.

12239-014

Figure 16. Graph Tools

**GENERATING A WAVEFORM ANALYSIS REPORT**

Figure 17 illustrates the tab used for a waveform capture.

Click **Single Capture** or **Continuous Capture** (labeled 1 in Figure 17) to capture samples from the ADC and graph the resulting waveform.

Graph controls (labeled 2 in Figure 17) are located above the graph and can be used to pan and zoom into particular areas of

the graph (see the Graph Tools section and Figure 16 for more information).

The **Waveform Analysis** area (labeled 3 in Figure 17) shows statistics pertaining to the captured waveform, such as maximum, minimum, and mean amplitudes and signal frequency.

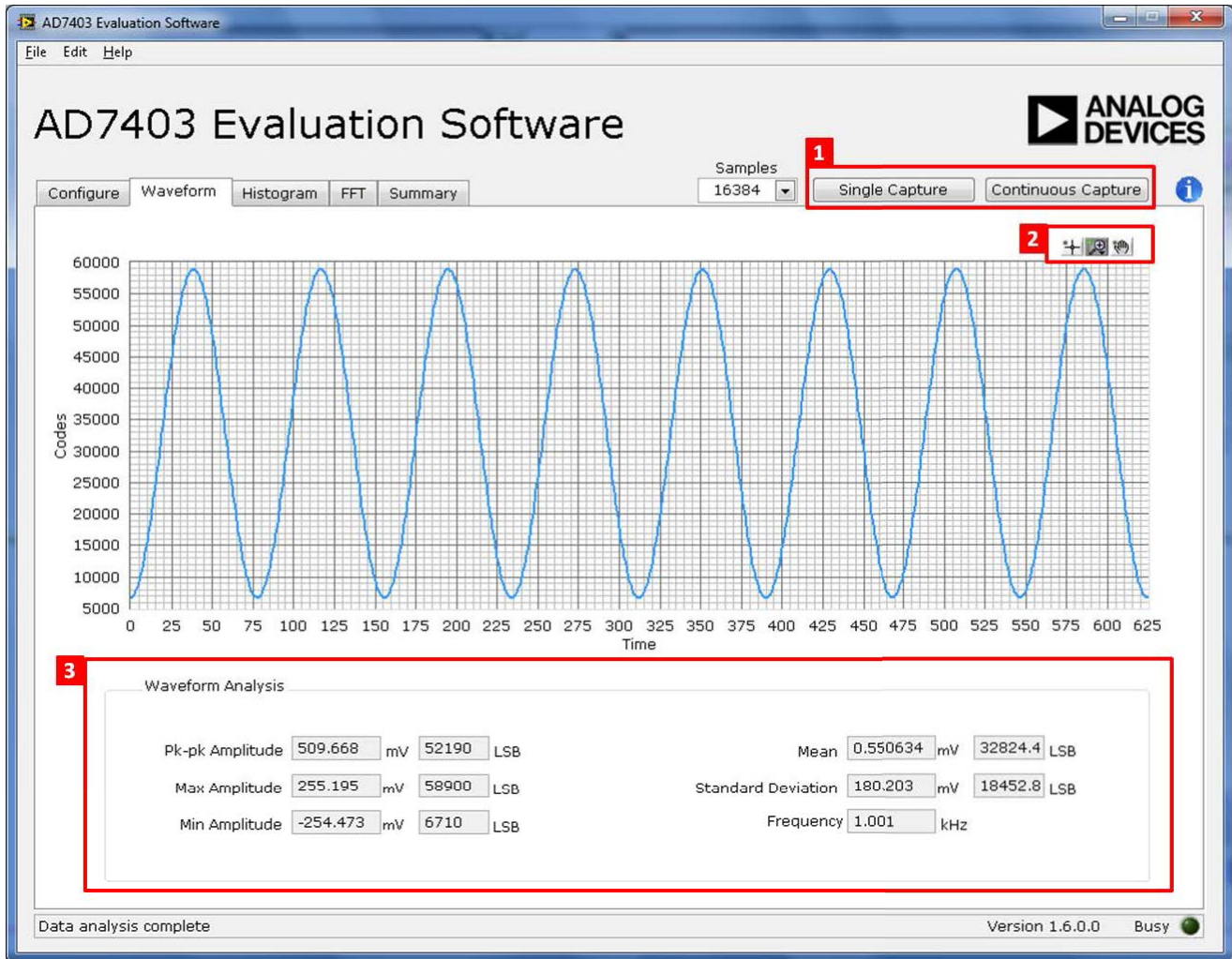

Figure 17. Waveform Capture Tab



### GENERATING A HISTOGRAM OF THE ADC CODE DISTRIBUTION

The **Histogram** tab can be used to perform ac testing or, more commonly, dc testing. This tab shows the ADC code distribution of the input and computes the mean and standard deviation, which are displayed as **DC Offset/Mean** and **Transition Noise**, respectively, in the **Histogram Analysis** area (labeled 2 in Figure 18).

#### AC Input

To perform a histogram test of ac input,

1. Apply a quality signal source to the VIN+ input on the board.
2. Click the **Histogram** tab from the main window.
3. Click **Single Capture** or **Continuous Capture** (labeled 1 in Figure 18).

Raw data is then captured and passed to the PC for statistical computations, and various measured values are displayed in the **Histogram Analysis** area (labeled 2 in Figure 18).

#### DC Input

A histogram test of dc input can be performed with or without an external source because the evaluation board can be configured with grounded inputs.

To perform a histogram test of dc input,

1. If an external source is being used, apply a signal source to the selected analog input. It may be required to filter the signal to ensure that the dc source is noise-compatible with the ADC.
2. Click the **Histogram** tab from the main window.
3. Click **Single Capture** or **Continuous Capture** (labeled 1 in Figure 18).

Raw data is then captured and passed to the PC for statistical computations, and various measured values are displayed in the **Histogram Analysis** area (labeled 2 in Figure 18).

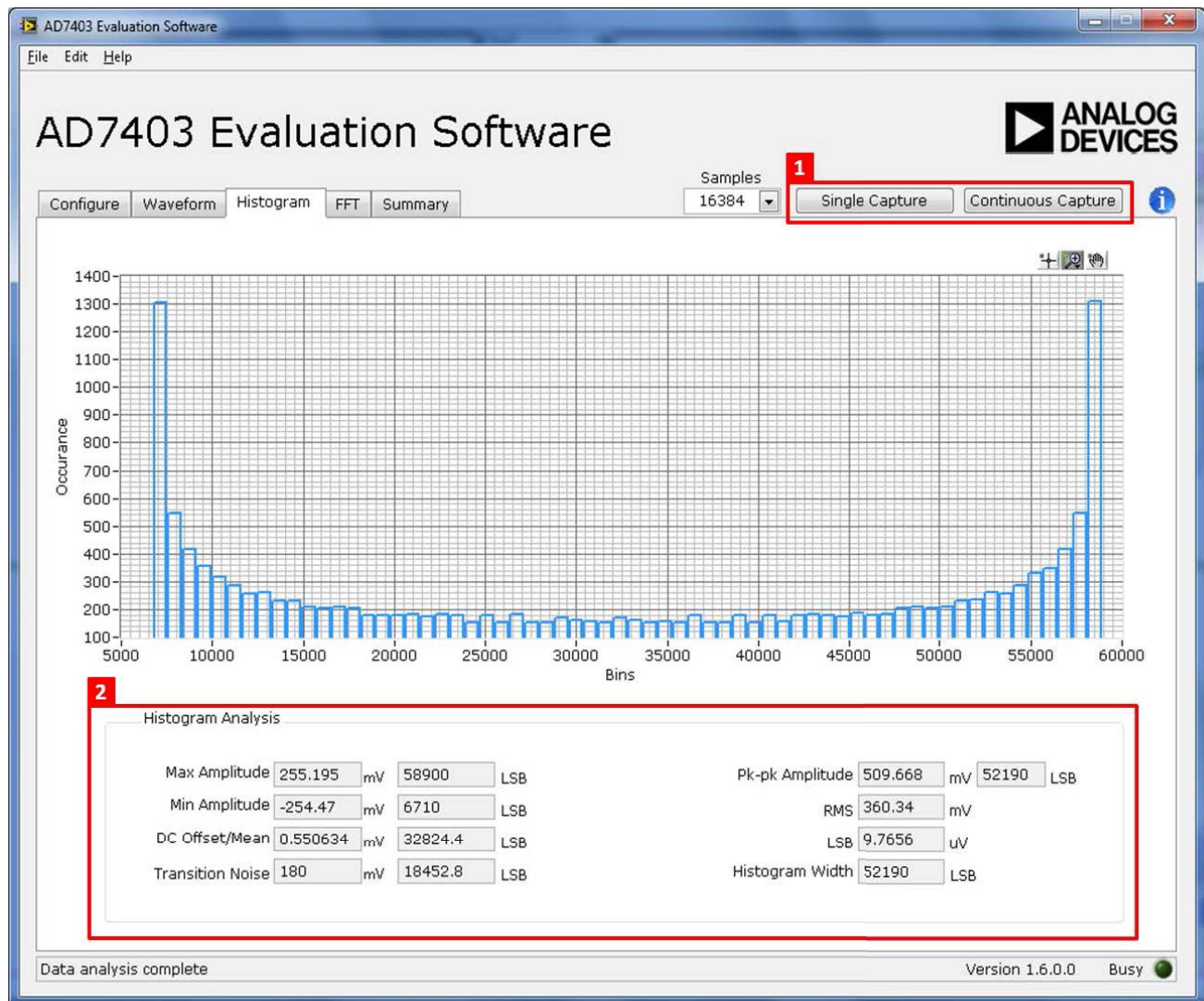

Figure 18. Histogram Capture Tab



**GENERATING A FAST FOURIER TRANSFORM OF AC CHARACTERISTICS**

Figure 19 shows the FFT tab. This feature tests the traditional ac characteristics of the converter and displays a fast Fourier transform (FFT) of the results.

To perform an ac FFT test,

1. Apply a bipolar sinusoidal signal with low distortion (better than 115 dB) to the evaluation board at the VIN+ input. To attain the requisite low distortion, which is necessary to allow true evaluation of the part, one option is to filter the input signal from the ac source. Choose an appropriate band-pass filter based on the sinusoidal signal applied.
2. Click the FFT tab from the main window.
3. Click **Single Capture** or **Continuous Capture**.

As in the histogram test, raw data is then captured and passed to the PC, which performs the FFT and displays the resulting SNR, THD, and SINAD.

Figure 19 displays the spectral analysis results of the captured data.

- The plot is the FFT image of the raw data.
- The **FFT Analysis** box displays the performance data: SNR, THD, SINAD, dynamic range, and noise performance along with the input signal characteristics (see label 1 in Figure 19).
- Clicking **Show Harmonic Content** (see label 2 in Figure 19) displays the frequency and amplitude of the fundamental in addition to the second to fifth harmonics.

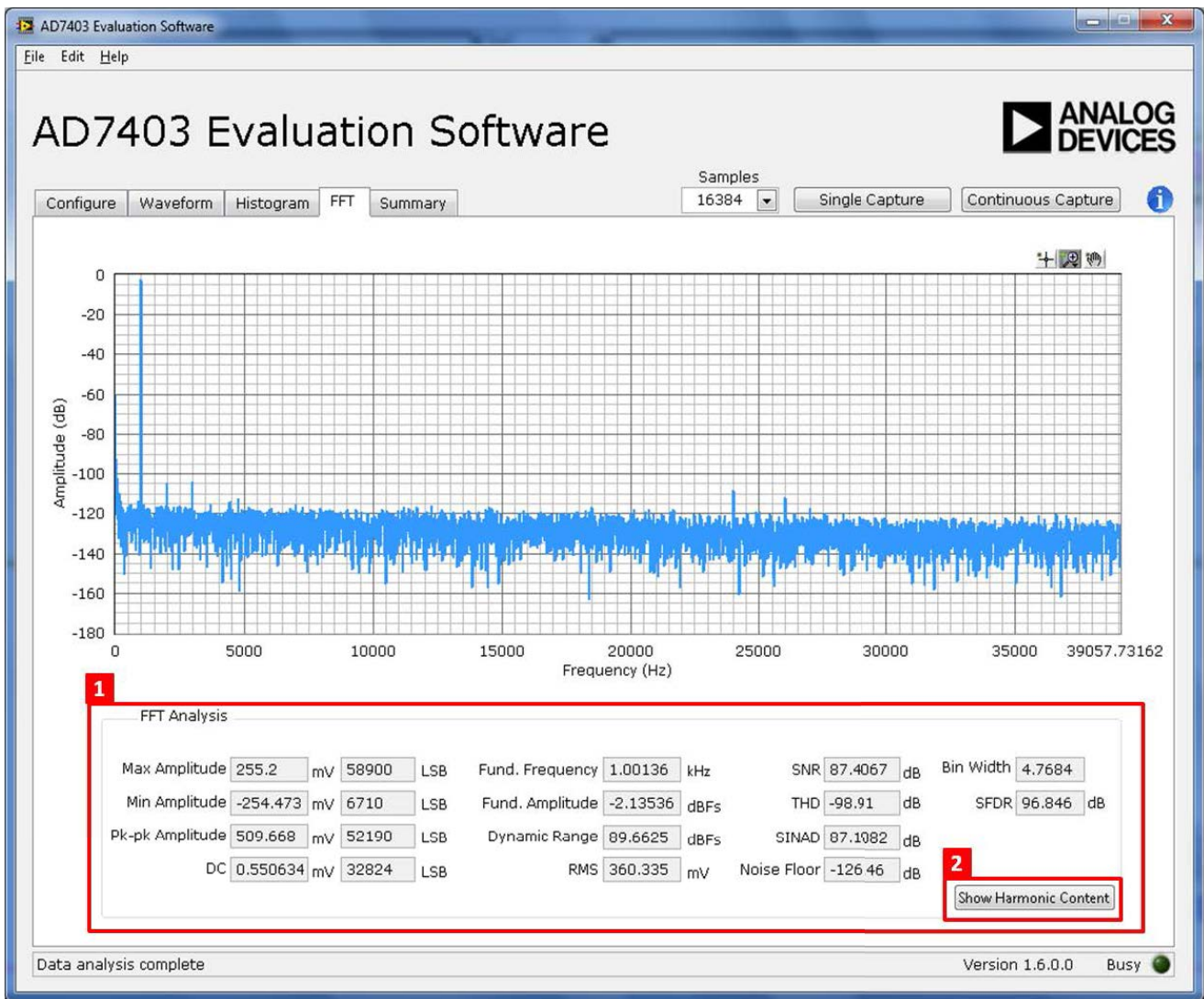

Figure 19. FFT Capture Tab

**GENERATING A SUMMARY OF THE WAVEFORM, HISTOGRAM, AND FAST FOURIER TRANSFORM**

Figure 20 shows the **Summary** tab. This tab captures and displays all of the information in one window with a synopsis of the information, including key performance parameters, such as SNR and THD (see the SNR and THD boxes, labeled 1 and 2, respectively, in Figure 20).

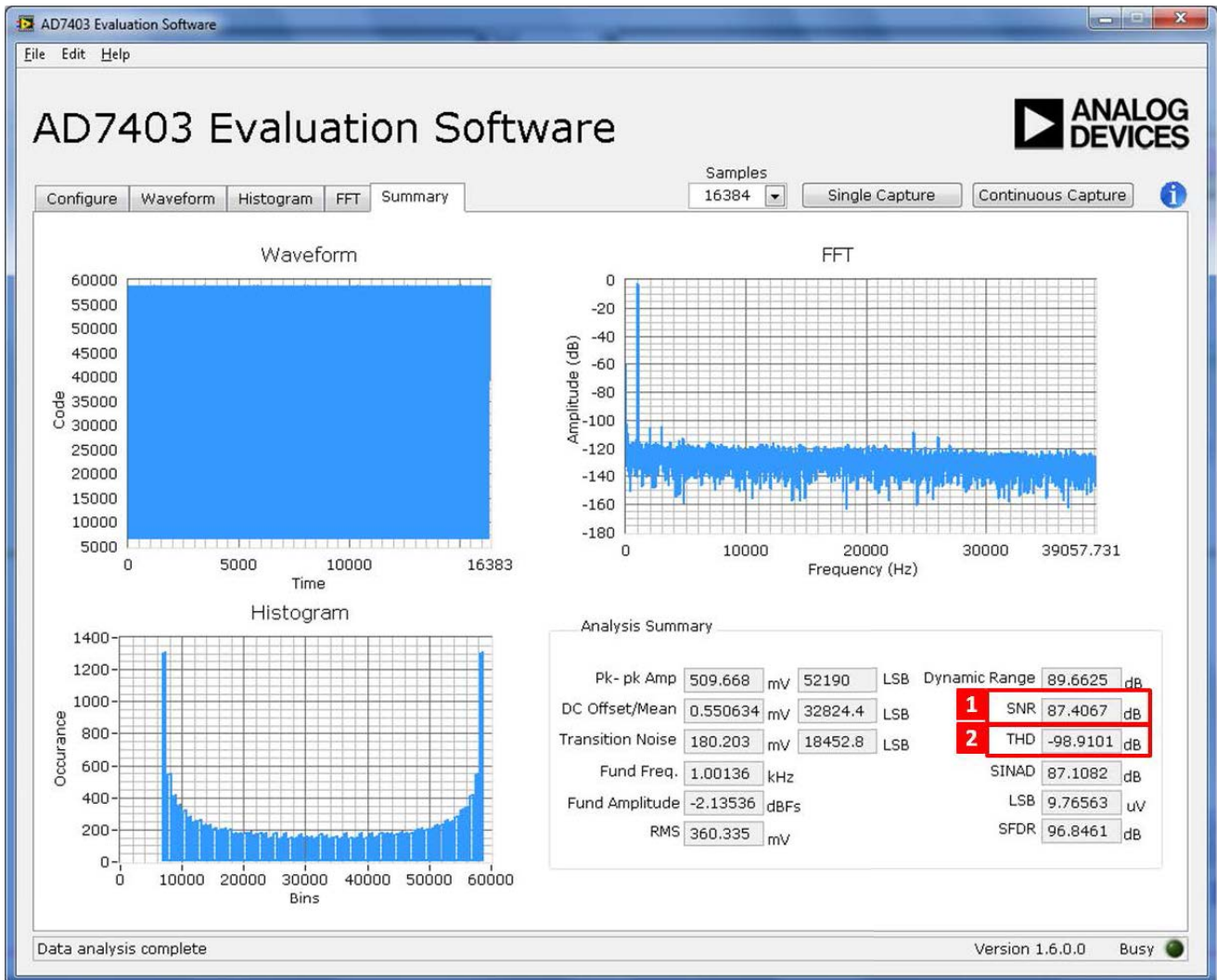

Figure 20. Summary Tab

12238-018

**SAVING FILES**

The software can save the current captured data for future analysis. The software also has the ability to save or print a screenshot of the currently displayed window.

**Saving Captured Data**

To save data, from the **File** menu, select **Save Captured Data**. The **Save As** dialog box shown in Figure 21 opens. Save the file to an appropriate folder location. Waveform data is saved in .csv format and can be opened for further analysis in other software, such as Excel or MATLAB®.

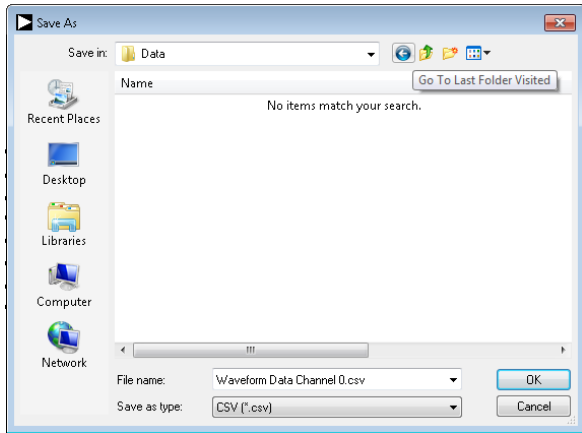

Figure 21. Dialog Box for Saving a File

**Saving a Screenshot**

To save a screenshot, from the **File** menu, select **Take Screenshot**. The **Select the JPEG file to write** dialog box in Figure 22 opens. Save the file to an appropriate folder location. Screenshots are saved in .jpeg format and can be viewed with any picture viewer/editor.

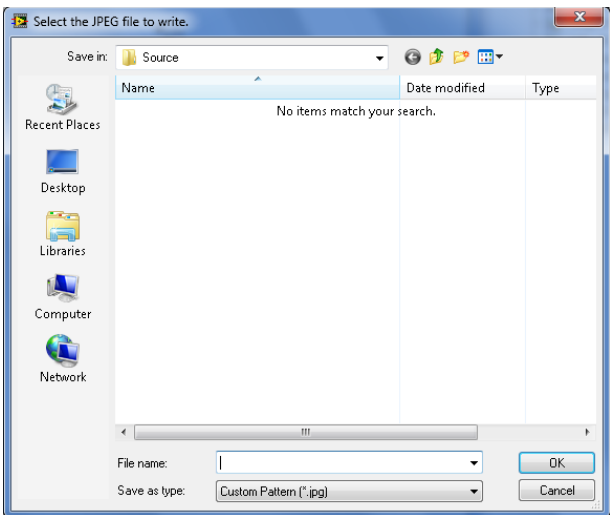

Figure 22. Dialog Box for Saving a Screenshot

**PRINTING A SCREENSHOT**

To print a screenshot, from the **File** menu, select **Print Screenshot**. The screenshot is sent to the default printer. No dialog will appear when printing a screenshot.

**OPENING FILES**

**Loading Captured Data**

The software can load previously captured data for analysis.

From the **File** menu, select **Load Captured Data**. Only data that was previously captured and saved can be opened. The raw data is used to rebuild the histogram and ac spectrum analyses upon being loaded into the evaluation platform.

When **Load Captured Data** is selected, the **Open** file dialog box in Figure 23 opens for loading an appropriate file. The evaluation software expects that a previously generated waveform file is in .csv format.

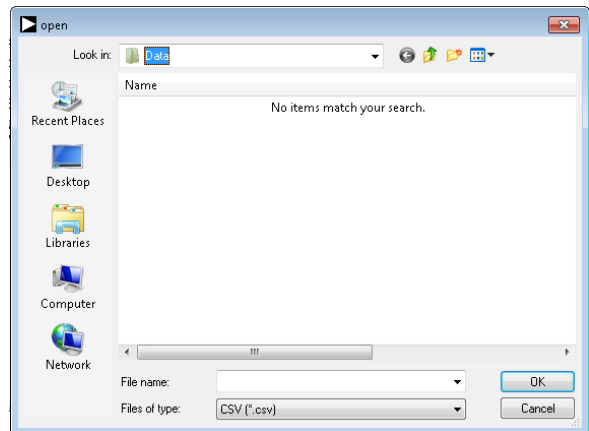

Figure 23. Dialog Box for Opening a File

**NOTES**

## NOTES

**ESD Caution**

**ESD (electrostatic discharge) sensitive device.** Charged devices and circuit boards can discharge without detection. Although this product features patented or proprietary protection circuitry, damage may occur on devices subjected to high energy ESD. Therefore, proper ESD precautions should be taken to avoid performance degradation or loss of functionality.

**Legal Terms and Conditions**

By using the evaluation board discussed herein (together with any tools, components documentation or support materials, the "Evaluation Board"), you are agreeing to be bound by the terms and conditions set forth below ("Agreement") unless you have purchased the Evaluation Board, in which case the Analog Devices Standard Terms and Conditions of Sale shall govern. Do not use the Evaluation Board until you have read and agreed to the Agreement. Your use of the Evaluation Board shall signify your acceptance of the Agreement. This Agreement is made by and between you ("Customer") and Analog Devices, Inc. ("ADI"), with its principal place of business at One Technology Way, Norwood, MA 02062, USA. Subject to the terms and conditions of the Agreement, ADI hereby grants to Customer a free, limited, personal, temporary, non-exclusive, non-sublicensable, non-transferable license to use the Evaluation Board FOR EVALUATION PURPOSES ONLY. Customer understands and agrees that the Evaluation Board is provided for the sole and exclusive purpose referenced above, and agrees not to use the Evaluation Board for any other purpose. Furthermore, the license granted is expressly made subject to the following additional limitations: Customer shall not (i) rent, lease, display, sell, transfer, assign, sublicense, or distribute the Evaluation Board; and (ii) permit any Third Party to access the Evaluation Board. As used herein, the term "Third Party" includes any entity other than ADI, Customer, their employees, affiliates and in-house consultants. The Evaluation Board is NOT sold to Customer; all rights not expressly granted herein, including ownership of the Evaluation Board, are reserved by ADI. CONFIDENTIALITY. This Agreement and the Evaluation Board shall all be considered the confidential and proprietary information of ADI. Customer may not disclose or transfer any portion of the Evaluation Board to any other party for any reason. Upon discontinuation of use of the Evaluation Board or termination of this Agreement, Customer agrees to promptly return the Evaluation Board to ADI. ADDITIONAL RESTRICTIONS. Customer may not disassemble, decompile or reverse engineer chips on the Evaluation Board. Customer shall inform ADI of any occurred damages or any modifications or alterations it makes to the Evaluation Board, including but not limited to soldering or any other activity that affects the material content of the Evaluation Board. Modifications to the Evaluation Board must comply with applicable law, including but not limited to the RoHS Directive. TERMINATION. ADI may terminate this Agreement at any time upon giving written notice to Customer. Customer agrees to return to ADI the Evaluation Board at that time. LIMITATION OF LIABILITY. THE EVALUATION BOARD PROVIDED HEREUNDER IS PROVIDED "AS IS" AND ADI MAKES NO WARRANTIES OR REPRESENTATIONS OF ANY KIND WITH RESPECT TO IT. ADI SPECIFICALLY DISCLAIMS ANY REPRESENTATIONS, ENDORSEMENTS, GUARANTEES, OR WARRANTIES, EXPRESS OR IMPLIED, RELATED TO THE EVALUATION BOARD INCLUDING, BUT NOT LIMITED TO, THE IMPLIED WARRANTY OF MERCHANTABILITY, TITLE, FITNESS FOR A PARTICULAR PURPOSE OR NON-INFRINGEMENT OF INTELLECTUAL PROPERTY RIGHTS. IN NO EVENT WILL ADI AND ITS LICENSORS BE LIABLE FOR ANY INCIDENTAL, SPECIAL, INDIRECT, OR CONSEQUENTIAL DAMAGES RESULTING FROM CUSTOMER'S POSSESSION OR USE OF THE EVALUATION BOARD, INCLUDING BUT NOT LIMITED TO LOST PROFITS, DELAY COSTS, LABOR COSTS OR LOSS OF GOODWILL. ADI'S TOTAL LIABILITY FROM ANY AND ALL CAUSES SHALL BE LIMITED TO THE AMOUNT OF ONE HUNDRED US DOLLARS (\$100,000). EXPORT. Customer agrees that it will not directly or indirectly export the Evaluation Board to another country, and that it will comply with all applicable United States federal laws and regulations relating to exports. GOVERNING LAW. This Agreement shall be governed by and construed in accordance with the substantive laws of the Commonwealth of Massachusetts (excluding conflict of law rules). Any legal action regarding this Agreement will be heard in the state or federal courts having jurisdiction in Suffolk County, Massachusetts, and Customer hereby submits to the personal jurisdiction and venue of such courts. The United Nations Convention on Contracts for the International Sale of Goods shall not apply to this Agreement and is expressly disclaimed.