		Shenzhen Tactile Intelligent Technology Co., Ltd.	
Title		IDO-SBC2D06-V1	
Size	Document Number	NOTE	Rev
A3			
Date:	Wednesday, April 14, 2021	Sheet	1 of 10

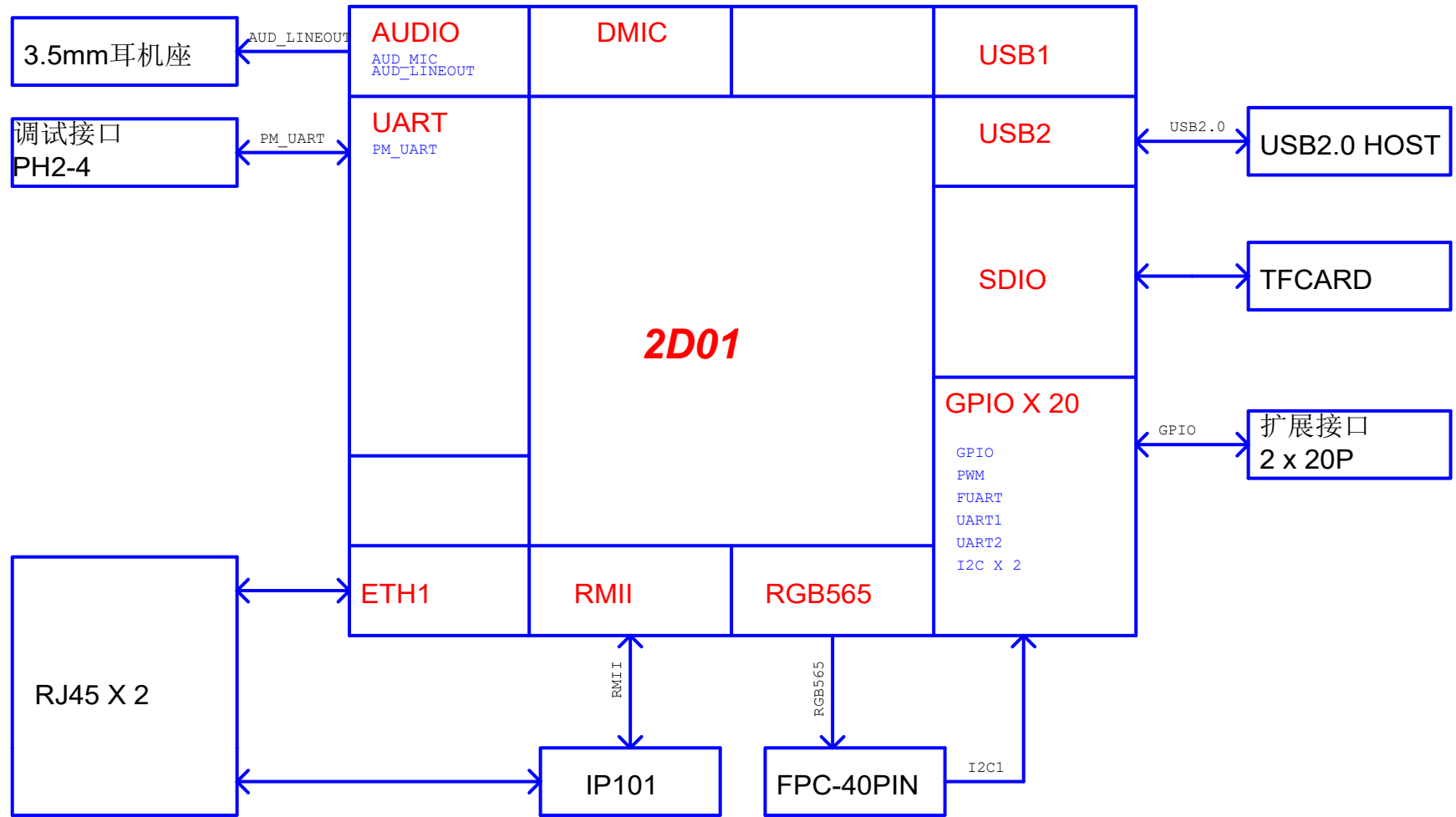

		Shenzhen Tactile Intelligent Technology Co., Ltd.	
Title		IDO-SBC2D06-V1	
Size	Document Number	Rev	
A3	POWER TREE		
Date:		Wednesday, April 14, 2021	Sheet 2 of 10

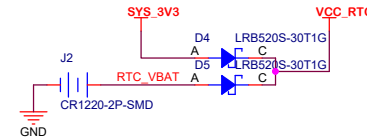

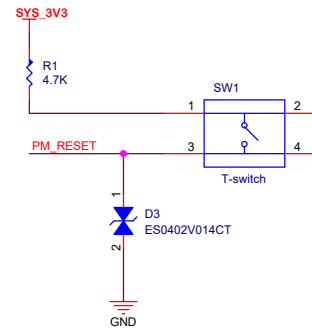
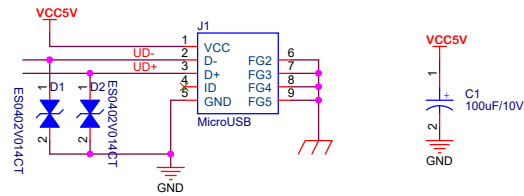
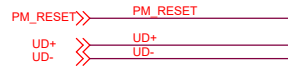

SYS_3V3

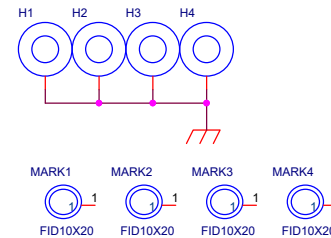
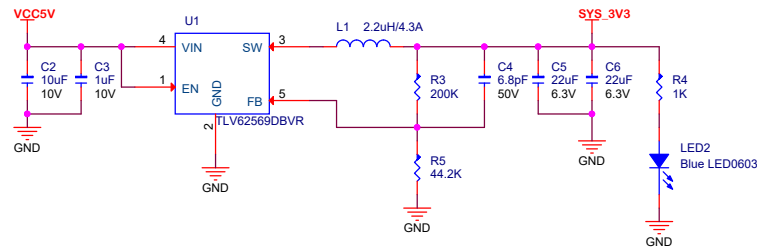

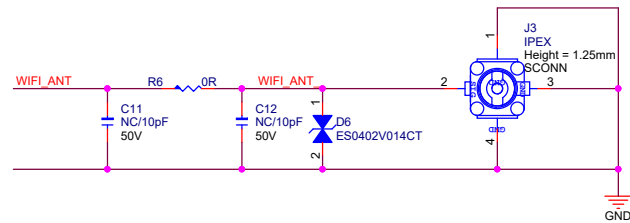
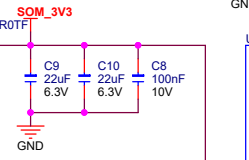
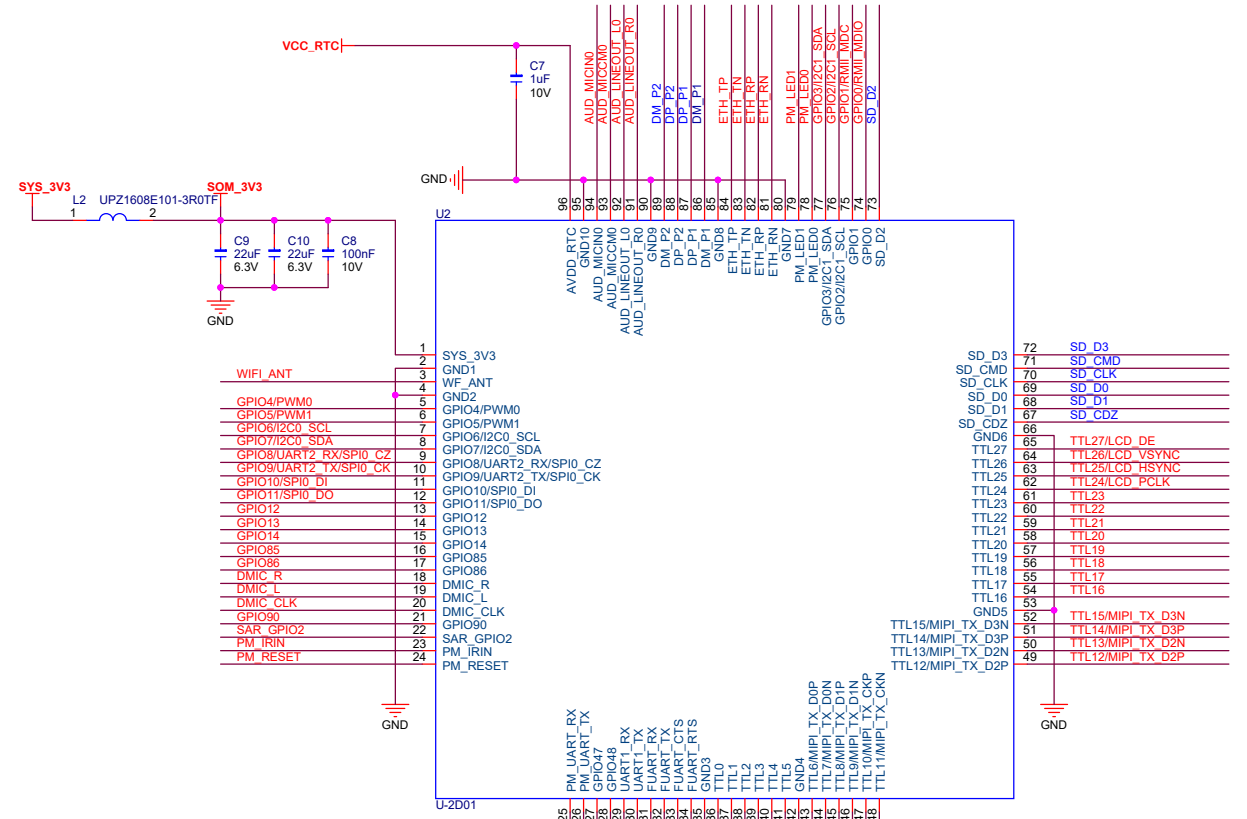
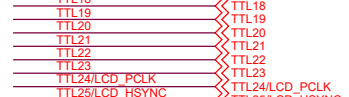
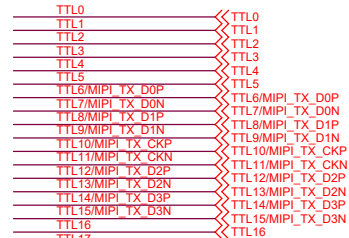
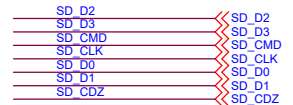
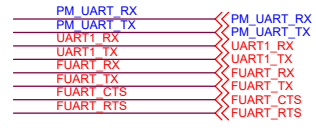
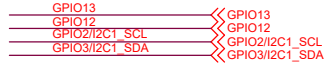
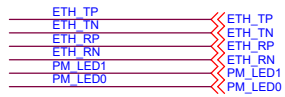
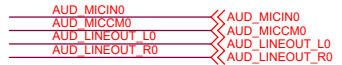
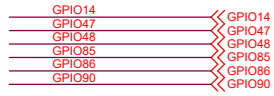

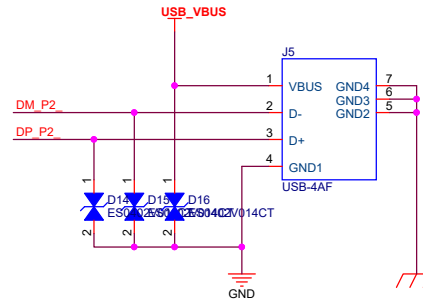
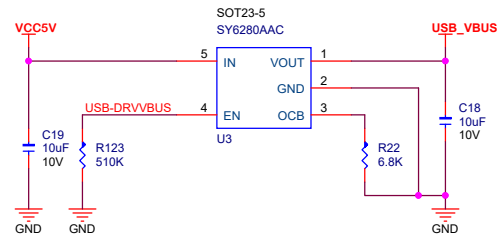
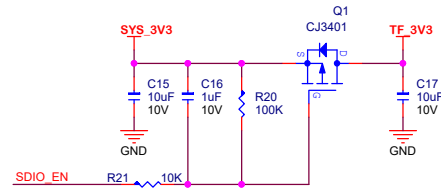
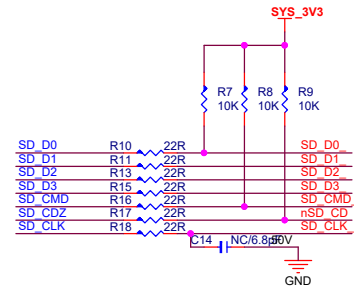
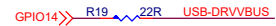
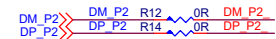
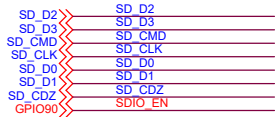

TF_CARD

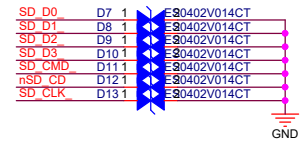
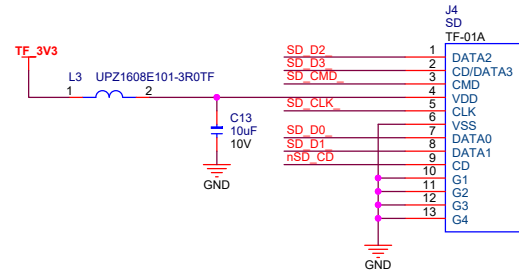

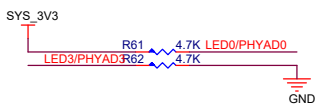
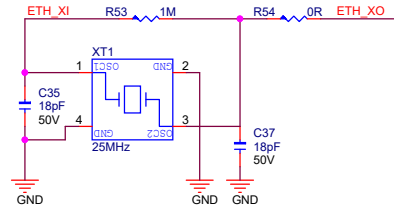
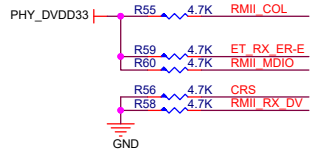
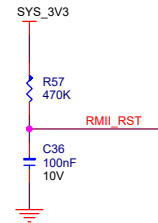
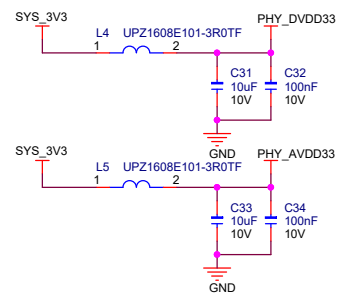
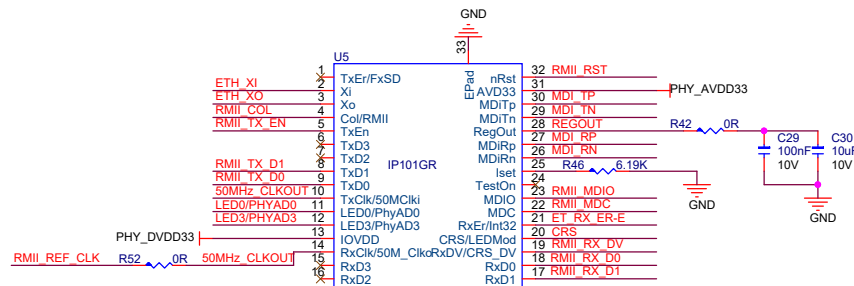
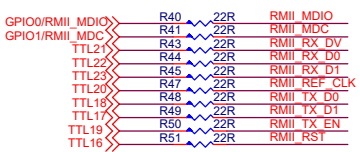
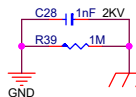
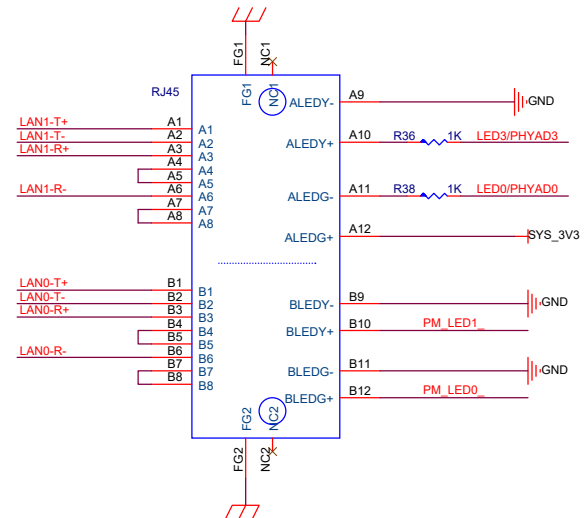
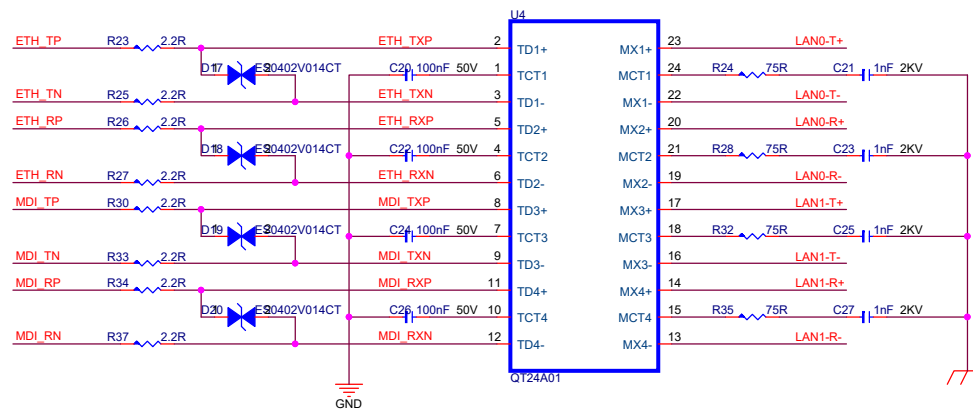
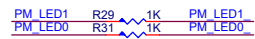
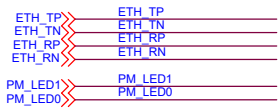

Shenzhen Tactile Intelligent Technology Co., Ltd.
 Title: IDO-SBC2D06-V1
 Size A3 Document Number: ETHERNET
 Date: Wednesday, April 14, 2021 Sheet 7 of 10

LCD

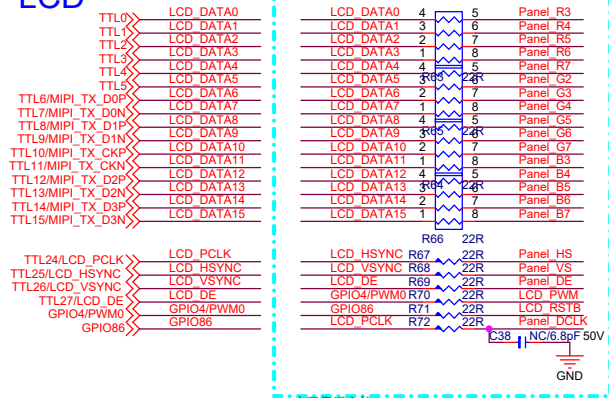

22R电阻靠近主控

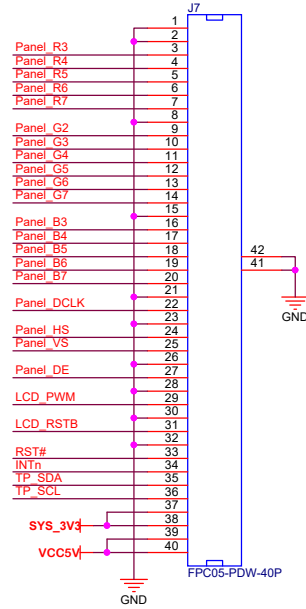

TP

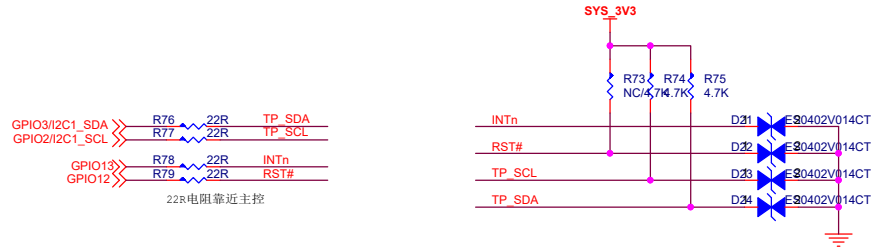

AUD_LINEOUT_L0 >>> AUD_LINEOUT_L0
 AUD_LINEOUT_R0 >>> AUD_LINEOUT_R0
 GPIO14 >>> MUTE

LINE OUT

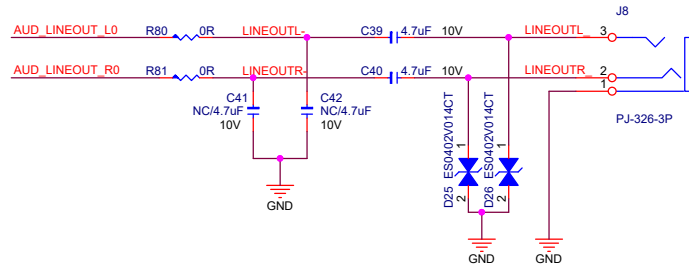

AUD_MICIN0 >>> AUD_MICIN0
 AUD_MICCM0 >>> AUD_MICCM0
 DMIC_R >>> DMIC_R
 DMIC_L >>> DMIC_L
 DMIC_CLK >>> DMIC_CLK

