

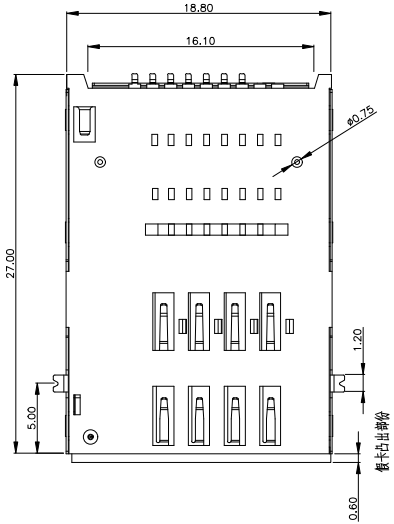

REV.	ECN NO OR DESCRIPTION	REVISED	DATE

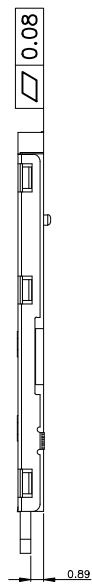

pin no.	name
C1	vcc of sim
C2	rst of sim
C3	clk of sim
C5	gnd of sim
C6	vpp of sim
C7	I/O of sim
C4/C8	n/a

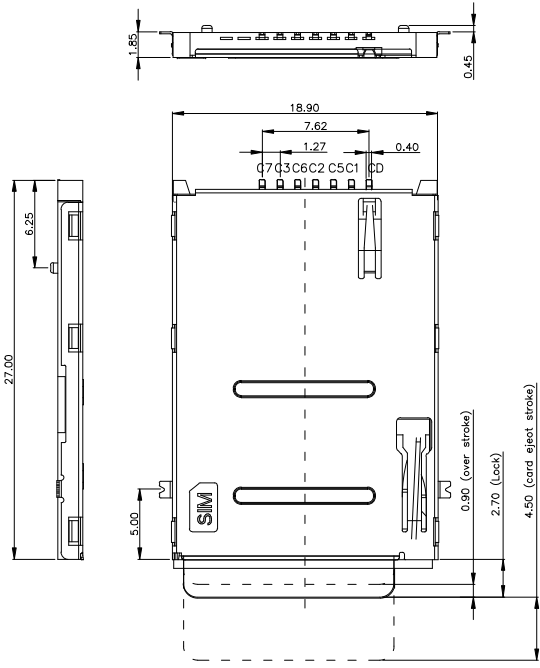
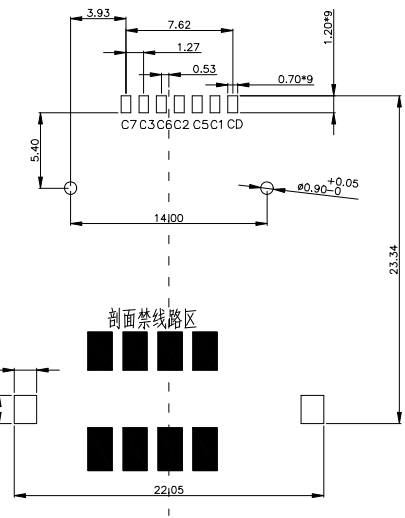
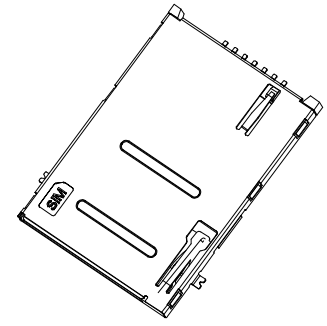
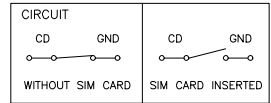

RECOMMENDED PCB LAYOUT  
GENERAL TOLERANCE  $\pm 0.05$

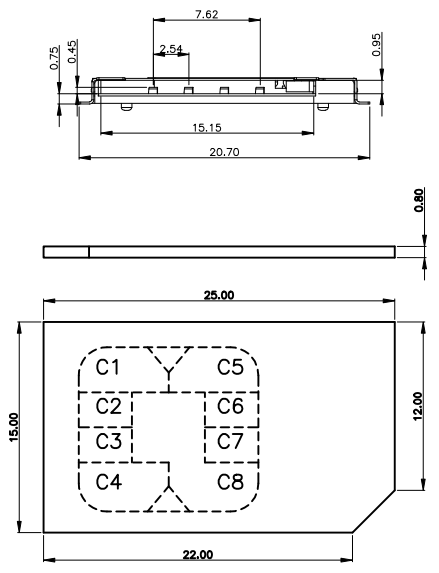

- Notes:
- Material:
    - Housing: LCP Color: black (塑胶材质: LCP 94-V0 黑色)
    - Contact: Phosphor Bronze. (端子材质: 磷青铜)
    - SHELL: SUS (外壳材质: 不锈钢)
  - All NI30u"Min Contact 1u", solder area Tin 30u/min (全部镀底30u", 接触点1u", 焊接处镀30u")
  - shell Ni 30" min ,solder gold Flash (镀底30"u, 焊接处镀金)
- SPECIFICATION:
- DURABILITY: 5000 CYCLES MIN (寿命: 5000次最小)
  - CURRENT: 0.5A (额定电流: 0.5Amps)
  - VOLTAGE: 40V MAX (额定电压: 40V最大)
  - WITHSTANDING VOLTAGE: 500V AC MIN. (UNMATED) (耐压: 500V AC最小)
  - CONTACT RESISTANCE: 30mΩ MAX. (端子接触电阻: 30mΩ最大)
  - INSULATION RESISTANCE: 1000MΩ MIN. (UNMATED) (绝缘阻抗: 1000兆欧最小)
  - OPERATING TEMPERATURE RANGE: -40.C TO +85.C (工作环境温度: -40度到+80度)
  - ALL THE MATERIAL SHOULD COMPLY WITH THE ROHS (全部材质符合ROHS)

UNLESS OTHERWISE SPECIFIED TOLERANCES		东莞市汉博电子科技有限公司 DONGGUAN HANBO TECHNOLOGY CO., LTD			
DECIMALS:	ANGLES:	TITLE	Mini sim card push push 8+1P 有柱右开关后脚		
X : $\pm 0.5$	X : $\pm 2^\circ$	DWN	xiong	SIM-210	
X.X : $\pm 0.20$	X.X : $\pm 1^\circ$	CHKD	lee	SCALE: 1:1	UNIT: mm
X.XX : $\pm 0.10$		APVD	wang	SIZE: A4	SHEET: 10F 1
		REV: A4			
CUSTOMER COPY					