

## Water Cooled RF Power Pot Capacitors, External Cooling System



### FEATURES

- High voltage, current, and power ratings
- Compact design reduces terminal self inductance and permits high frequency operation
- Increased power density is achieved through water cooling. Enhanced reliability is achieved with a rugged mechanical design

### APPLICATIONS

Water cooled RF power pot capacitors are designed for use in the tank circuits of high power RF equipment such as induction heating and welding equipment, dielectric heating, and a variety of specialized RF applications.

### DESIGN SUPPORT TOOLS AVAILABLE



QUICK REFERENCE DATA													
DESCRIPTION	VALUE												
Ceramic class	1												
Ceramic dielectric	R7, R16, R42, R85												
Type	TWX						TWXF						
Voltage (V <sub>p</sub> )	12 000	14 000	16 000	20 000	25 000	10 000	12 000	14 000	16 000	18 000	20 000	22 500	25 000
Min. capacitance (pF)	5000	100	4000	3000	2500	10 000	5000	100	4000	7600	3000	7500	2500
Max. capacitance (pF)	5000	5000	4000	3000	2500	10 000	5000	10 000	10 000	10 000	7600	7500	5000
Mounting	Screw terminal												

### PRODUCT DESCRIPTION

TWX and TWXF pot-styled capacitors dissipate the heat produced under load by means of water flow around the capacitor element. In order to provide protection from influences of the chemical / physical characteristics of the coolant, a glass passivation layer is applied over the cooled noble metal electrode. The ceramic capacitor element is housed in a rugged copper case.

The electrical terminations are directly soldered onto the noble metal electrodes, providing a strong, rigid connection of unsurpassed reliability. The TWX model is made with a contoured, glazed insulation rim designed for use in a clean, dry environment. The TWXF types feature an umbrella shaped coating rim made from silicone elastomer to minimize the adverse effects of moisture, dust, and other soiling in the working environment, and to improve the characteristics of the electrical field.

### MARKING

Type designator, capacitance value and tolerance, rated RF voltage, ceramic material code, production date code, manufacturer logo, serial number.

### ACCESSORIES ADDED

All water cooled pot capacitors are supplied with the necessary screws / nuts and contact plates to make the connection to the electrode terminals. Ferrules and sleeve nuts for the water supply connections are also included.

### CAPACITANCE RANGE

100 pF to 10 nF

### CAPACITANCE TOLERANCE

± 20 %; ± 10 %

### CERAMIC DIELECTRICS

- R7 (TCC: +100 ppm/K)
- R16 (TCC: +100 ppm/K)
- R42 (TCC: -250 ppm/K)
- R85 (TCC: -750 ppm/K)

### RATED VOLTAGE

- 10 kV<sub>p</sub>
- 12 kV<sub>p</sub>
- 14 kV<sub>p</sub>
- 16 kV<sub>p</sub>
- 18 kV<sub>p</sub>
- 20 kV<sub>p</sub>
- 22.5 kV<sub>p</sub>
- 25 kV<sub>p</sub>

### DIELECTRIC STRENGTH TEST

200 % of rated AC voltage, 50 Hz

### RF POWER TEST

125 % to 140 % of rated power, for 10 minutes in a test generator circuit

### DISSIPATION FACTOR

R7: max. 0.07 %  
 R16: max. 0.04 %  
 R42, R85: max. 0.05 %

Measuring frequencies:

1 MHz (< 1 nF); 300 kHz or 100 kHz (≥ 1 nF)

### INSULATION RESISTANCE

Min. 10 000 MΩ (at 25 °C)

### OPERATING TEMPERATURE RANGE

Find details of water cooling under the “Guidelines” section in the [datasheet](#).



**SAP PART NUMBER AND ELECTRICAL DATA**

PART NUMBER	CERAMIC	CAP. VALUES (pF)	RATED VOLTAGE (kV <sub>p</sub> )	RATED POWER (kvar)	RATED CURRENT (A <sub>RMS</sub> )	MIN. WATER FLOW RATE PER MINUTE (liter / US-gal.)	PERMISSIBLE INSTALLATION POS. <sup>(1)</sup>			
<b>TYPE TWX</b>										
WX095162WJ101##BF1	R7	100	14	1100	150	1.0 / 0.27	Only vertical, umbrella-up position is permitted			
WX095162WJ201##BF1		200								
WX095162WJ401##BG1	R16	400		1500						
WX095187WJ102##BH1	R42	1000		1000						
WX095162WJ152##BJ1	R85	1500		1500						
WX095162WJ202##BJ1		2000								
WX095162WJ252##BJ1		2500								
WX135242WP302##BJ1		3000		20				2000	200	1.4 / 0.38
WX110250WJ472##BJ1		4700		14				2000	200	1.4 / 0.38
WX095220WF502##BJ1	5000	12		1275				150	1.0 / 0.27	
WX110250WJ502##BJ1	5000	14	2000	200	1.4 / 0.38					

**Note**

(1) ## 14<sup>th</sup> to 15<sup>th</sup> digit: capacitance tolerance code ± 20 % = 38, ± 10 % = 36

**DIMENSIONS** in millimeters (inches)

PART NUMBER	D <sub>1</sub>	D <sub>3</sub>	D <sub>4</sub>	D <sub>5</sub>	D <sub>6</sub>	L <sub>1</sub>	L <sub>2</sub>	L <sub>3</sub>	
<b>TYPE TWX</b>									
WX095162WJ101##BF1	95 (3.74)	94 (3.70)	85 (3.35)	30 (1.18)	40 (1.57)	162 (6.38)	55 (2.17)	18 (0.71)	
WX095162WJ201##BF1									
WX095162WJ401##BG1									
WX095187WJ102##BH1						187 (7.36)	80 (3.15)		
WX095162WJ152##BJ1									
WX095162WJ202##BJ1									
WX095162WJ252##BJ1	162 (6.38)	55 (2.17)							
WX135242WP302##BJ1			135 (5.31)	135 (5.31)	122 (4.80)	50 (1.97)	242 (9.53)	108 (4.25)	22 (0.87)
WX110250WJ472##BJ1			110 (4.33)	108 (4.25)	98 (3.86)	45 (1.77)	248 (9.76)	115 (4.53)	18 (0.71)
WX095220WF502##BJ1	95 (3.74)	94 (3.70)	85 (3.35)	40 (1.57)	220 (8.66)				
WX110250WJ502##BJ1	110 (4.33)	108 (4.25)	98 (3.86)	45 (1.77)	248 (9.76)				

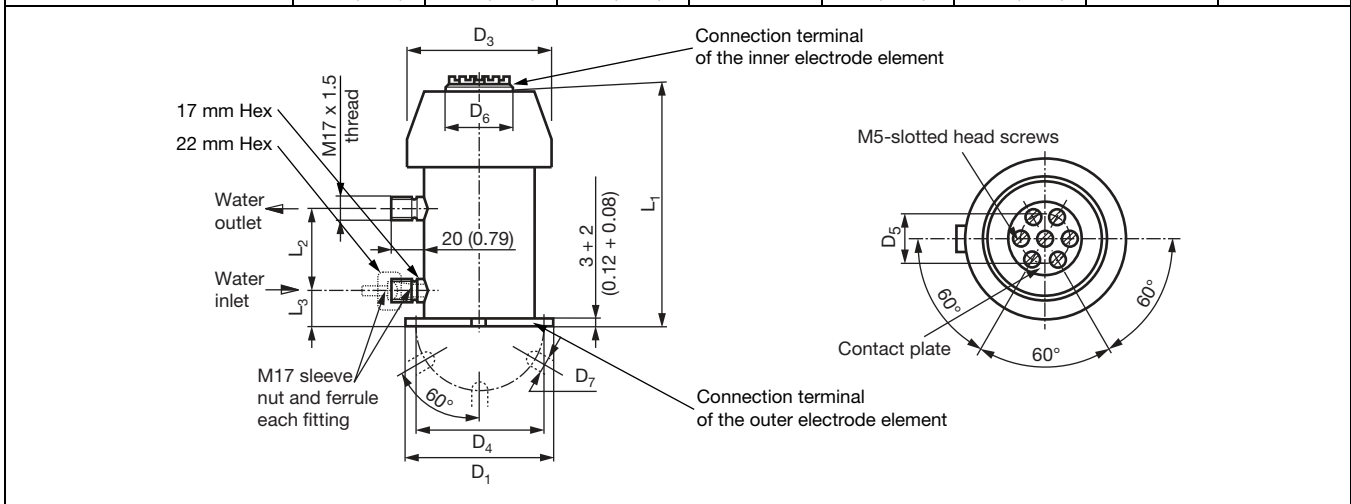



SAP PART NUMBER AND ELECTRICAL DATA										
PART NUMBER	CERAMIC	CAP. VALUES (pF)	RATED VOLTAGE (kV <sub>p</sub> )	RATED POWER (kvar)	RATED CURRENT (A <sub>RMS</sub> )	MIN. WATER FLOW RATE PER MINUTE (liter / US-gal.)	PERMISSIBLE INSTALLATION POS. (1)(2)(3)			
<b>TYPE TWXF</b>										
WF095162WJ101##BF1	R7	100	14	1100	150	1.0 / 0.27	(1)(2)(3)			
WF095162WJ201##BF1		200								
WF095162WJ401##BG1	R16	400		1500						
WF095187WJ102##BH1	R42	1000		1000						
WF095162WJ152##BJ1	R85	1500		1500						
WF095162WJ202##BJ1		2000		2500						
WF095162WJ252##BJ1		2500		2500						
WF135242BQ252##BJ1		2500		25				2500	250	2.1 / 0.57
WF135242WP302##BJ1		3000		20				2000	200	1.4 / 0.38
WF135218WL402##BJ1		4000		16				2500	250	1.8 / 0.49
WF110250WJ472##BJ1		4700	14	2000	200	1.4 / 0.38				
WF095220WF502##BJ1		5000	12	1275	150	1.0 / 0.27				
WF110250WJ502##BJ1		5000	14	2000	200	1.4 / 0.38				
WF135250WL502##BJ1		5000	16	2830	250	2.0 / 0.54				
WF135285WP502##BJ1		5000	20	3000	250	2.1 / 0.57				
WF135373BQ502##BJ1		5000	25	3200	250	2.3 / 0.62				
WF135272WL602##BJ1		6000	16	2830	250	2.0 / 0.54				
WF165278WP602##BJ1		6000	20	3000	270	2.1 / 0.57	(1)			
WF165270WJ752##BJ1		7500	14	3000	300	2.1 / 0.57	(1)(3)			
WF165336WQ752##BJ1		7500	22.5	4000	350	2.9 / 0.80	(1)(3)			
WF125300WJ762##BJ1		7600	14	2500	250	1.4 / 0.38	(1)(2)(3)			
WF165270WL762##BJ1		7600	16	2830	250	2.0 / 0.54	(1)			
WF125420WN762##BJ1	7600	18	2500	250	2.0 / 0.54	(1)(3)				
WF165336WP762##BJ1	7600	20	3200	270	2.3 / 0.62	(1)				
WF125300BH103##BJ1	10 000	10	2000	280	1.4 / 0.38	(1)(2)(3)				
WF125405WJ103##BJ1	10 000	14	2800	290	2.1 / 0.57	(1)				
WF165335WL103##BJ1	10 000	16	3395	300	2.5 / 0.70	(1)(3)				
WF165420WN103##BJ1	10 000	18	2500	250	2.0 / 0.54	(1)(3)				

**Notes**

## 14<sup>th</sup> to 15<sup>th</sup> digit: capacitance tolerance code ± 20 % = 38; ± 10 % = 36

Permissible installation position:

- (1) Only vertical, umbrella-up position is permitted
- (2) Vertical, umbrella-down position
- (3) Horizontal mounting, water connections topside

• Special versions with additional water-emptying screw or with ERMETO fittings are available on request. Please contact us.



DIMENSIONS in millimeters (inches)																		
PART NUMBER	D <sub>1</sub>	D <sub>2</sub>	D <sub>4</sub>	D <sub>5</sub>	D <sub>6</sub>	D <sub>7</sub>	L <sub>1</sub>	L <sub>2</sub>	L <sub>3</sub>	B <sub>1</sub>	B <sub>2</sub>	FIG.						
<b>TYPE TWXF</b>																		
WF095162WJ101##BF1	95 (3.74)	110 (4.33)	85 (3.35)	30 (1.18)	40 (1.58)	5.5 (0.217)	162 (6.38)	55 (2.17)	18 (0.71)			1						
WF095162WJ201##BF1												1						
WF095162WJ401##BG1												1						
WF095187WJ102##BH1							187 (7.36)	80 (3.15)				1						
WF095162WJ152##BJ1							162 (6.38)	55 (2.17)				1						
WF095162WJ202##BJ1												1						
WF095162WJ252##BJ1												1						
WF135242BQ252##BJ1	135 (5.31)	148 (5.83)	122 (4.80)		50 (1.97)	6.5 (0.217)	242 (9.53)	108 (4.25)	22 (0.87)	-	-	1						
WF135242WP302##BJ1												218 (8.58)	1					
WF135218WL402##BJ1												45 (1.77)	248 (9.76)	1				
WF110250WJ472##BJ1	95 (3.47)	110 (4.33)	85 (3.35)		40 (1.58)	5.5 (0.217)	220 (8.66)	115 (4.53)	18 (0.71)			1						
WF095220WF502##BJ1	110 (4.33)	125 (4.92)	98 (3.86)		45 (1.77)							248 (9.76)	1					
WF110250WJ502##BJ1	135 (5.31)	148 (5.83)	122 (4.80)		50 (1.97)							6.5 (0.256)	250 (9.84)	134 (5.28)	22 (0.87)	1		
WF135250WL502##BJ1						285 (11.22)	1											
WF135285WP502##BJ1				373 (14.69)		216 (8.50)	1											
WF135373BQ502##BJ1				272 (10.71)		134 (5.28)	1											
WF135272WL602##BJ1	-	-	-	45 (1.77)	75 (2.95)	9.5 (0.374)	9.5 (0.374)	278 (10.94)	136 (5.35)			30 (1.18)	165 (6.50)	135 (5.31)	2			
WF165278WP602##BJ1	165 (6.60)	170 (6.69)	146 (5.75)				6.5 (0.256)	270 (10.63)	134 (5.28)			22 (0.87)	-	-	1			
WF165270WJ752##BJ1	-	-	-				30 (1.18)	50 (1.97)	336 (13.23)			194 (7.64)	165 (6.50)	135 (5.31)	2			
WF165336WQ752##BJ1															148 (5.83)	303 (11.93)	180 (7.09)	2
WF125300WJ762##BJ1															170 (6.69)	270 (10.63)	140 (5.51)	2
WF165270WL762##BJ1							148 (5.83)	30 (1.18)	50 (1.97)	420 (16.54)	280 (11.02)	127 (5.00)			98 (3.86)	2		
WF125420WN762##BJ1							170 (6.69)	45 (1.77)	75 (2.95)	336 (13.23)	194 (7.64)	30 (1.18)			165 (6.50)	135 (5.31)	2	
WF165336WP762##BJ1							148 (5.83)	30 (1.18)	50 (1.97)	303 (11.93)	180 (7.09)	127 (5.00)			98 (3.86)	2		
WF125300BH103##BJ1							405 (15.94)	280 (11.02)	2									
WF125405WJ103##BJ1							45 (1.77)	75 (2.95)	335 (13.19)	208 (8.82)	165 (6.50)	135 (5.31)			2			
WF165335WL103##BJ1							170 (6.69)	420 (16.54)	280 (11.02)	2								
WF165420WN103##BJ1										2								

**DIMENSIONS** in millimeters (inches)

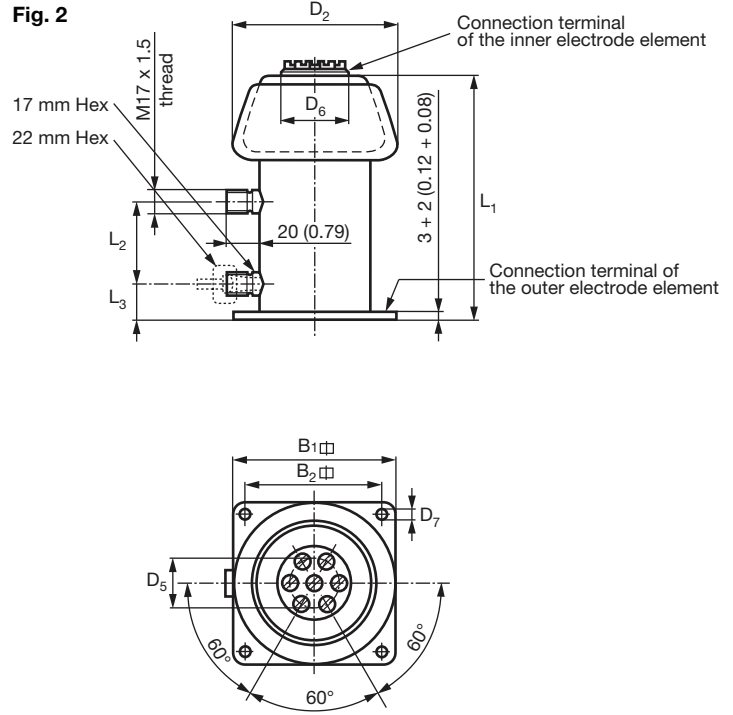
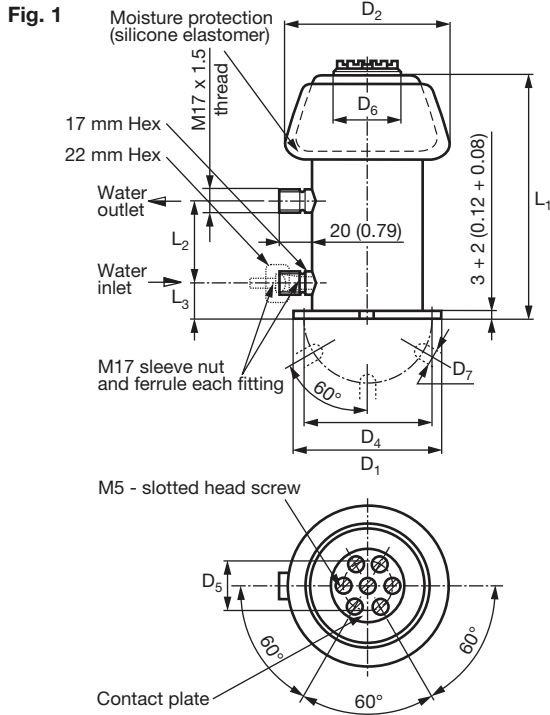

**DERATING DIAGRAMS**

**WX095162WJ101##BF1, WF095162WJ101##BF1**

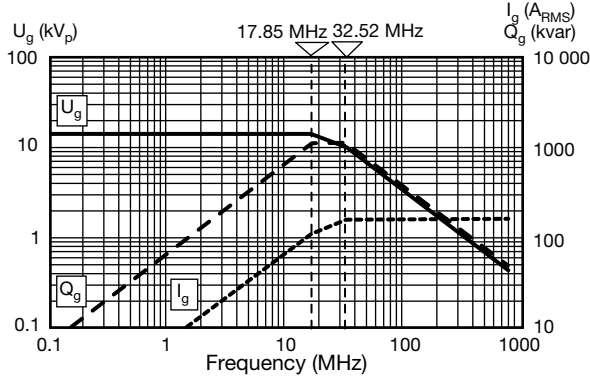

**WX095162WJ201##BF1, WF095162WJ201##BF1**

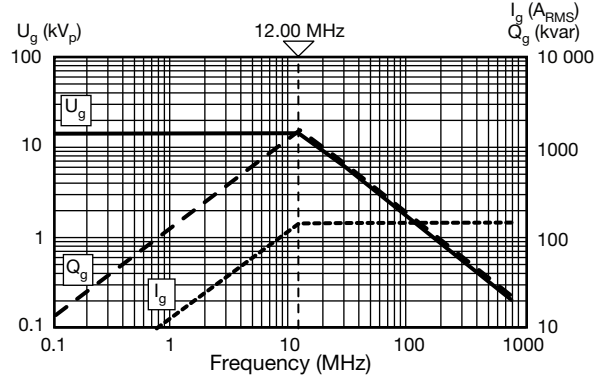

**WX095162WJ401##BG1, WF095162WJ401##BG1**

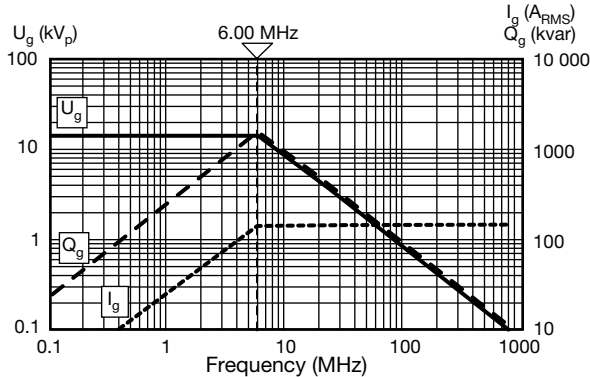

**WX095187WJ102##BH1, WF095187WJ102##BH1**

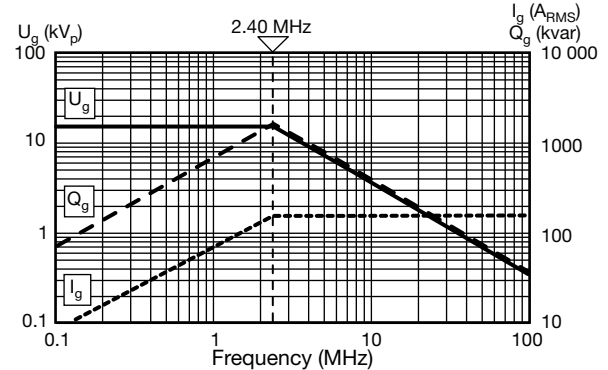

**DERATING DIAGRAMS**

**WX095162WJ152##BJ1, WF095162WJ152##BJ1**

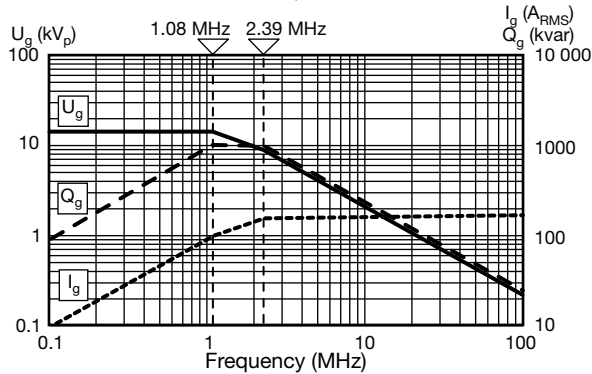

**WX095162WJ202##BJ1, WF095162WJ202##BJ1**

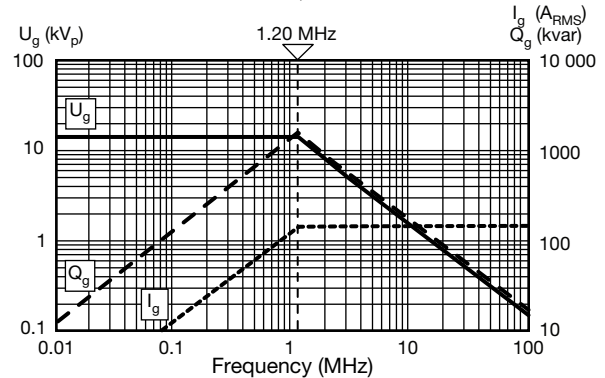

**WX095162WJ252##BJ1, WF095162WJ252##BJ1**

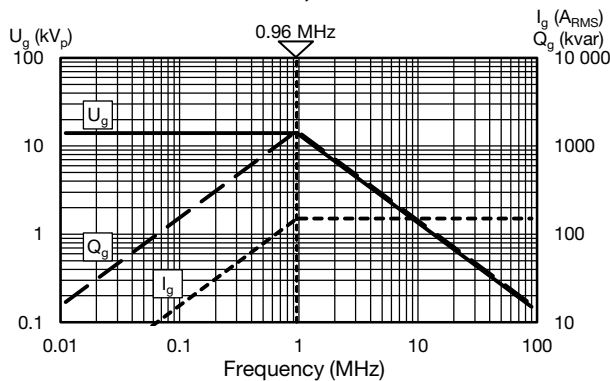

**WF135242BQ252##BJ1**

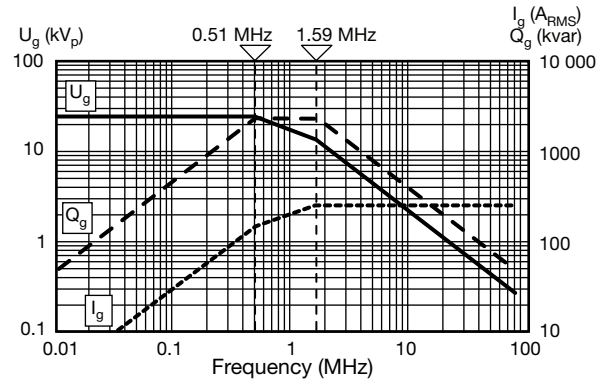

**WX135242WP302##BJ1, WF135242WP302##BJ1**

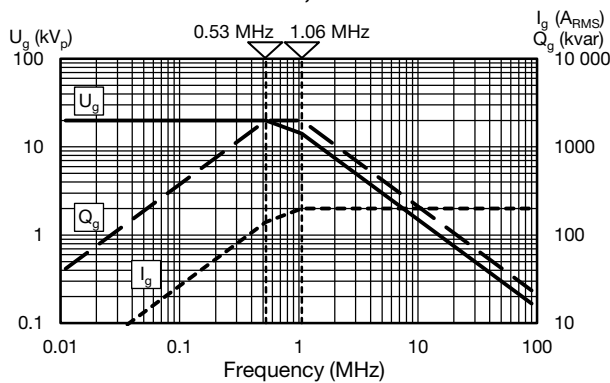

**WF135218WL402##BJ1**

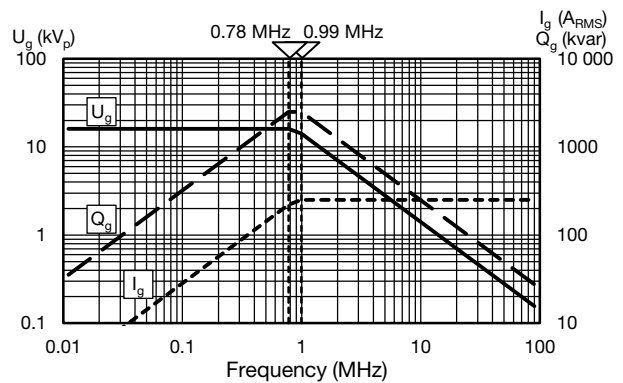

**WX110250WJ472##BJ1, WF110250WJ472##BJ1**

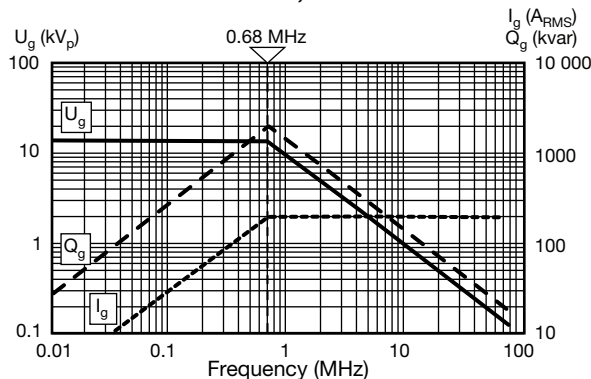

**WX095220WF502##BJ1, WF095220WF502##BJ1**

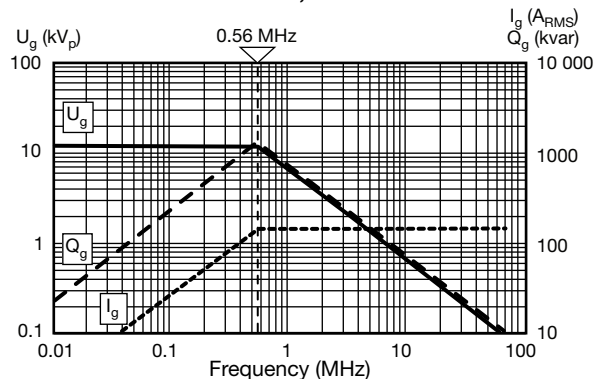



DERATING DIAGRAMS

WX110250WJ502##BJ1, WF110250WJ502##BJ1

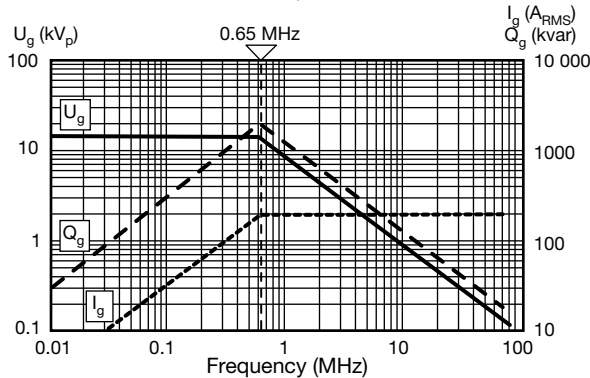

WF135250WL502##BJ1

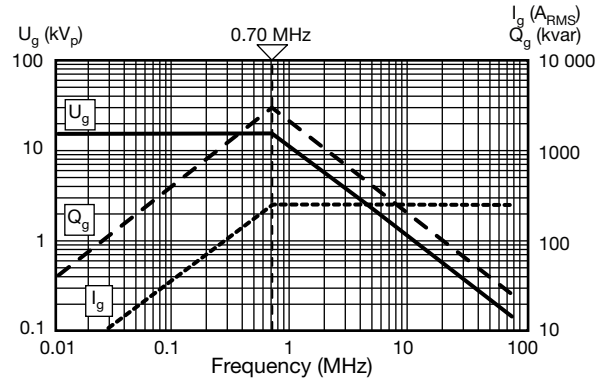

WF135285WP502##BJ1

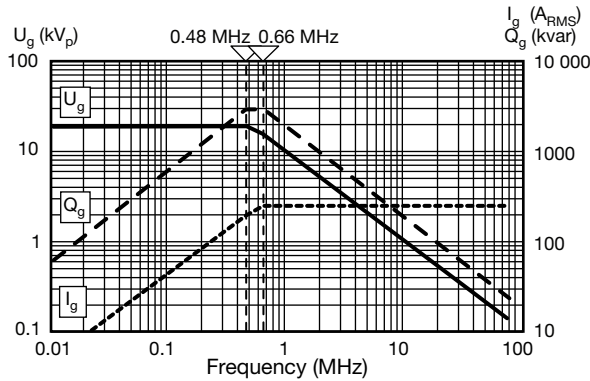

WF135273502BQ##BJ1

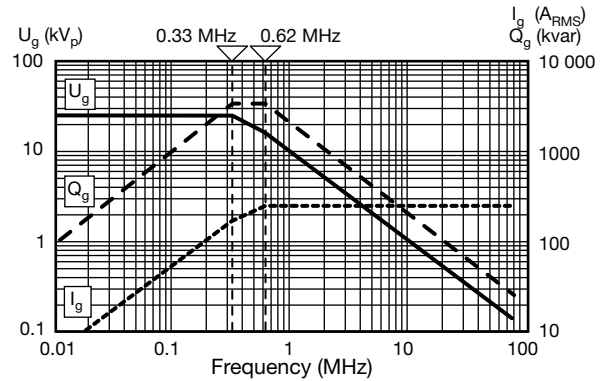

WF135272WL602##BJ1

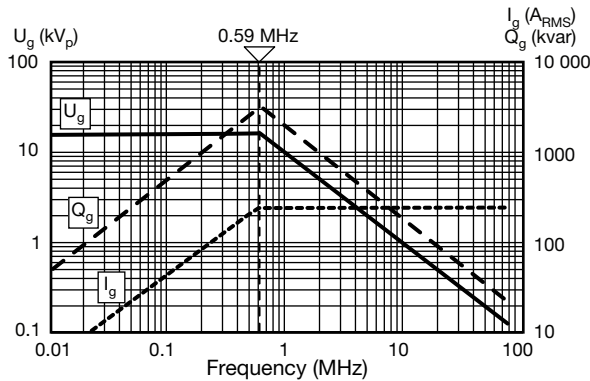

WF165278WP602##BJ1

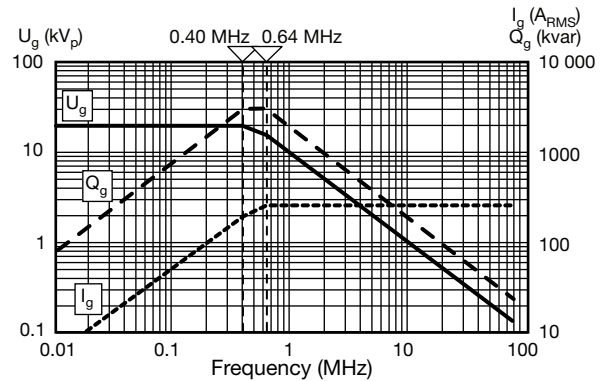

WF165270WJ752##BJ1

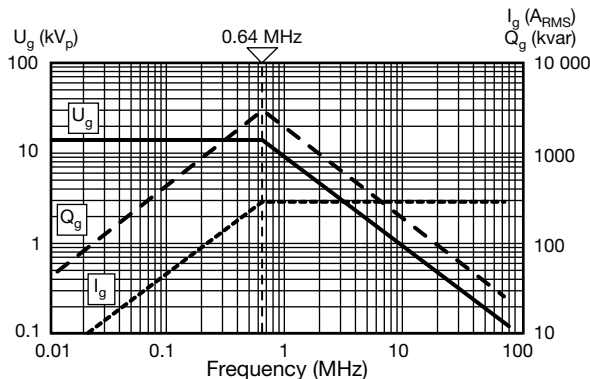

WF165336WQ752##BJ1

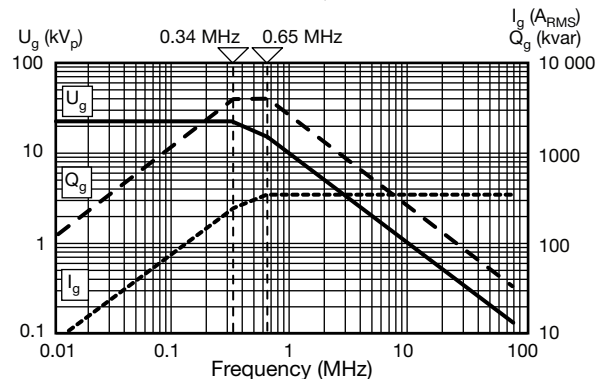



**DERATING DIAGRAMS**

**WF125300WJ762##BJ1**

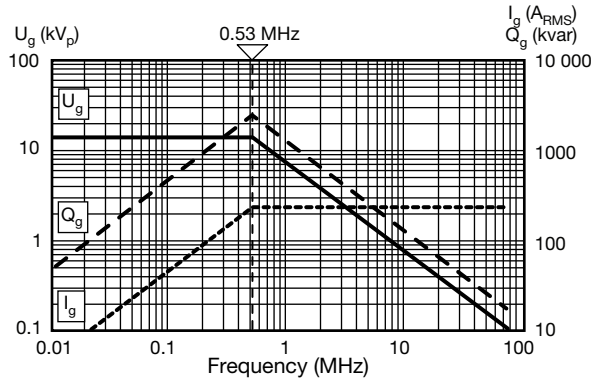

**WF165270WL762##BJ1**

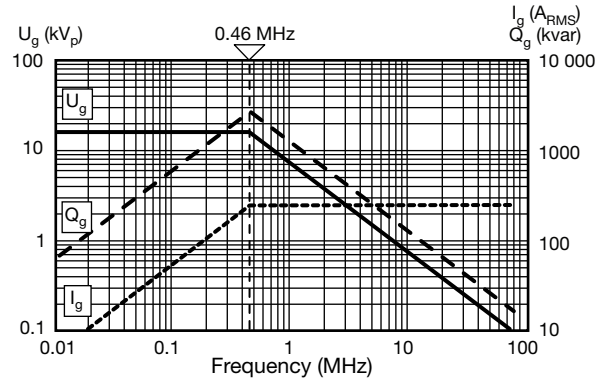

**WF125420WN762##BJ1**

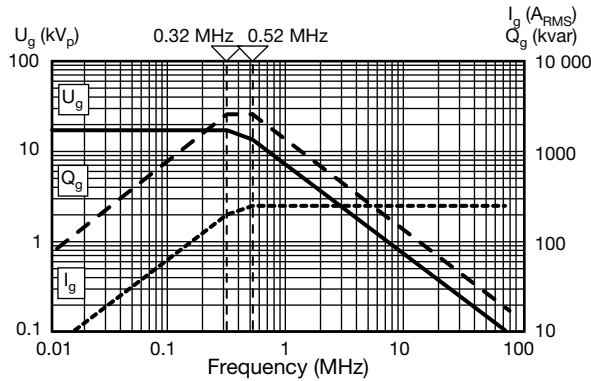

**WF165336WP762##BJ1**

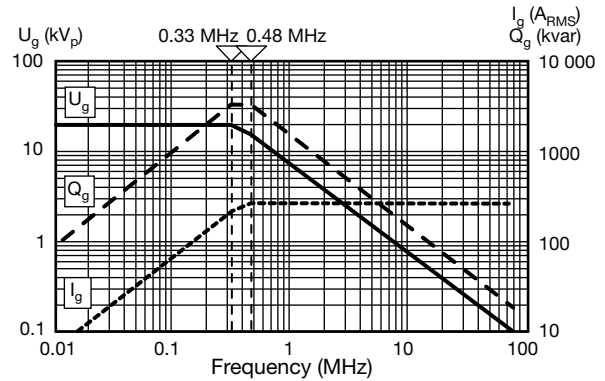

**WF125300BH103##BJ1**

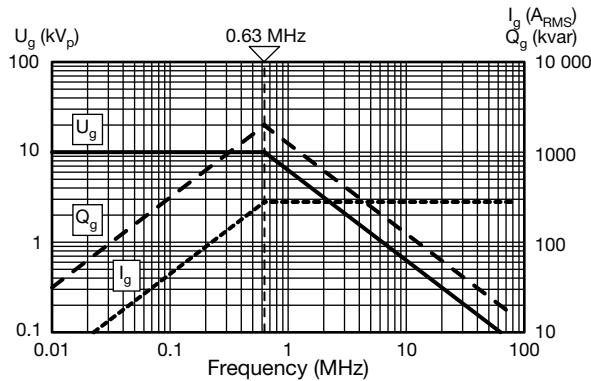

**WF125405WJ103##BJ1**

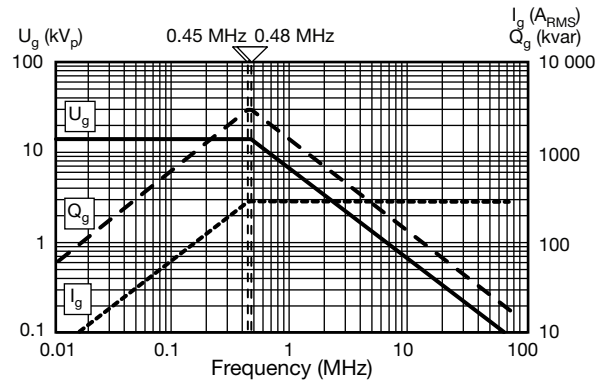

**WF165335WL103##BJ1**

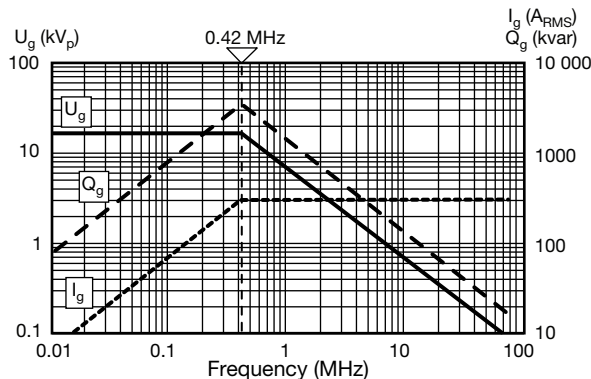

**WF165420WN103##BJ1**

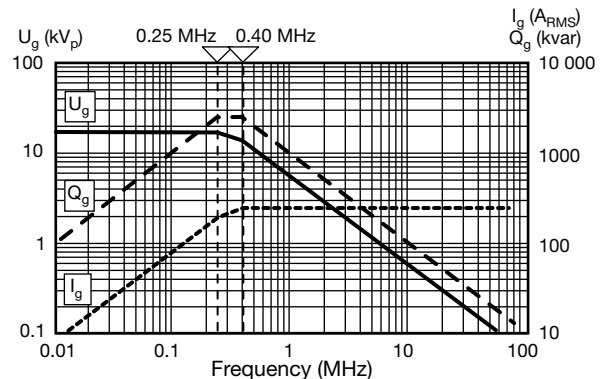





**GUIDELINES**

**ELECTRICAL DATA AND GUIDELINES**

- The main physical and electrical characteristics of the capacitors and ceramic materials used, are listed in the tables on the general section and in the individual datasheets
- The continuous limit values of voltage, current, and power given in the diagrams must be observed.
- The rated voltage given in the tables is the peak value of the sinusoidal AC voltage or the sum of the DC and peak AC voltages for which the capacitor is rated under continuous operation.
- The rated current in the tables is the effective value of the sinusoidal current for which the current paths of the capacitor are designed.

**INSTALLATION**

- Water cooled pot capacitors (TWX and TWXF) are designed to be installed in a vertical, umbrella-up position. Other positions may be allowed as shown on the individual datasheets. For large generators requiring multiple capacitors we recommended a circular mounting pattern for optimum circuit performance.
- When capacitors are connected in parallel, care should be taken to mount the top electrodes of the capacitor away from the RF-bus bar to minimize the effects of stray electromagnetic fields. The capacitors elements must not exceed a temperature of more than +100 °C.
- The electrical connection to the inner electrode must be flexible in order to prevent the generation of the physical forces which could damage the capacitor elements. Such forces are often generated by the dimensional differences resulting from the normal physical tolerances of the capacitors. The capacitor’s inner electrode connector must not be used as a mechanical support for other devices or components.

**COOLING**

- The cooling system is designed to operate at a maximum water pressure of 4 bars (58 psi).
- The water outlet of the capacitor must always be located higher than the water inlet in a vertical installation. This allows any air to escape from the unit. Horizontal installations require that both water connections be at the top-side of the unit. To preserve the capacitors from frost damages during the transport, we offer special models with outlet screws for emptying the cooling water from the unit.
- The minimum water flow rates specified in the tables must be observed. When using antifreeze mixtures, the flow rate should be increased by at least 20 %.
- The cooling system is designed to have a water temperature increase of < 10 °C (water inlet to water outlet) when the capacitor is operated at full rated power and the minimum water flow rate. A water intake temperature of ≤ 30 °C is recommended. If the cooling system of several capacitors is connected in series, the intake temperature of the coolant must not exceed 50 °C for any capacitors.
- The pressure drop in a series connected cooling system is small. The table below illustrates the effects upon water flow rates as a function of the number of series connected TWXF 135285 capacitors in the system with a constant intake water pressure of 3 bars (43.5 psi).

Number of cooling systems in series	1	2	3	4	5
Water flow rate (liters/minute)	13.0	10.5	8.5	7.3	6.0
Water flow rate (US-gal./minute)	3.43	2.77	2.24	1.92	1.58

- Intake water temperature fluctuations in excess of 3 °C/s must be avoided to prevent damage to the capacitor elements.
- A coolant temperature rate monitor must provide a fail-safe on / off power control for the RF equipment.
- Normal tap water or de-mineralized water may be used for cooling. The water must be reasonably free of CaCO<sub>3</sub> and clear of foreign particles or milkiness. The pH-value of the coolant should be between 6 and 8.



**QUALITY AND RELIABILITY**

**ELECTRICAL AND MECHANICAL SCREENING TESTS**

All capacitors are subjected to the following tests prior to shipment:

- Capacitance value (1.0 MHz or 0.1 MHz, 20 V<sub>RMS</sub>, 25 °C ± 5 °C)
- Dissipation factor (1.0 MHz or 0.3 MHz, 10 V<sub>RMS</sub>, 25 °C ± 5 °C)
- Insulation resistance (100 V<sub>DC</sub>, 25 °C ± 5 °C)
- Dielectric strength (200 % rated peak voltage, 50 Hz, 5 minutes)
- RF power test (125 % to 140 % rated power for 10 minutes in a test generator circuit)
- Pressure test (standard: 6 bars [87 psi] for 1 minute, 25 °C ± 5 °C)

**WARRANTY STIPULATION FOR WATER COOLED CERAMIC POWER RF CAPACITORS**

- Unless otherwise provided for hereinafter, warranty shall be governed by General Terms of Sale and Delivery.
- Warranty is assumed for capacitors which fail to operate owing to faults in material or production, and within the warranty period for capacitors
- Excluded from warranty are capacitors prematurely rendered unserviceable owing to improper treatment, overloading, circuit errors, as well as capacitors operated without observing the data given in our catalogue. Warranty is also excluded in cases where faults can no longer be recognized on the capacitor owing to third party interferences. Warranty is only effectively assumed when meeting the requirements referred to hereinafter.
- For claiming warranty, the defective capacitor should be returned to us, if possible in its original packing, within 14 days following the data of failure, being accompanied by the completely filled-in and signed Original Guarantee Certificate. The risks of transportation, as well as any shipping costs and other charges shall in any case be borne by the sender.
- Warranty can only become effective if the defective capacitor is received by us in the same condition as it was when it happened to fail.
- We have the right to inspect any records proving the use of the capacitor.
- The decision as to whether we are obliged to assume warranty for the capacitor shall exclusively rest with us.
- When acknowledging the warranty claim, any non-repairable capacitor shall remain our property. When refusing a warranty claim the defective capacitor will be returned at the customer's expense only if demanded so explicitly when asserting the warranty claim. In case examination required disassembly of the capacitor no claims for damage can be derived therefrom.
- The customer gives us the right to have the system checked in which the capacitor was operated.
- When acknowledging a warranty claim, restitution is made by supplying either a repaired and newly tested capacitor or by supplying a new one.
- Warranty shall only extend to the capacitor itself. Any further claims for damages are excluded.

**CONDITIONS OF GUARANTEE**

Pursuant to the foregoing stipulations we assume warranty for these water cooled pot capacitors up to a period of 5000 hours of operating service. Any claims for warranty, however will extinguish 24 months following the date of delivery.

<b>RELATED DOCUMENTS</b>	
General Information	<a href="http://www.vishay.com/doc?22071">www.vishay.com/doc?22071</a>



## Disclaimer

ALL PRODUCT, PRODUCT SPECIFICATIONS AND DATA ARE SUBJECT TO CHANGE WITHOUT NOTICE TO IMPROVE RELIABILITY, FUNCTION OR DESIGN OR OTHERWISE.

Vishay Intertechnology, Inc., its affiliates, agents, and employees, and all persons acting on its or their behalf (collectively, "Vishay"), disclaim any and all liability for any errors, inaccuracies or incompleteness contained in any datasheet or in any other disclosure relating to any product.

Vishay makes no warranty, representation or guarantee regarding the suitability of the products for any particular purpose or the continuing production of any product. To the maximum extent permitted by applicable law, Vishay disclaims (i) any and all liability arising out of the application or use of any product, (ii) any and all liability, including without limitation special, consequential or incidental damages, and (iii) any and all implied warranties, including warranties of fitness for particular purpose, non-infringement and merchantability.

Statements regarding the suitability of products for certain types of applications are based on Vishay's knowledge of typical requirements that are often placed on Vishay products in generic applications. Such statements are not binding statements about the suitability of products for a particular application. It is the customer's responsibility to validate that a particular product with the properties described in the product specification is suitable for use in a particular application. Parameters provided in datasheets and / or specifications may vary in different applications and performance may vary over time. All operating parameters, including typical parameters, must be validated for each customer application by the customer's technical experts. Product specifications do not expand or otherwise modify Vishay's terms and conditions of purchase, including but not limited to the warranty expressed therein.

Hyperlinks included in this datasheet may direct users to third-party websites. These links are provided as a convenience and for informational purposes only. Inclusion of these hyperlinks does not constitute an endorsement or an approval by Vishay of any of the products, services or opinions of the corporation, organization or individual associated with the third-party website. Vishay disclaims any and all liability and bears no responsibility for the accuracy, legality or content of the third-party website or for that of subsequent links.

Except as expressly indicated in writing, Vishay products are not designed for use in medical, life-saving, or life-sustaining applications or for any other application in which the failure of the Vishay product could result in personal injury or death. Customers using or selling Vishay products not expressly indicated for use in such applications do so at their own risk. Please contact authorized Vishay personnel to obtain written terms and conditions regarding products designed for such applications.

No license, express or implied, by estoppel or otherwise, to any intellectual property rights is granted by this document or by any conduct of Vishay. Product names and markings noted herein may be trademarks of their respective owners.