

KPS-MCC Indust COG HT200C, Ceramic, 0.056 uF, 10%, 630 VDC, COG

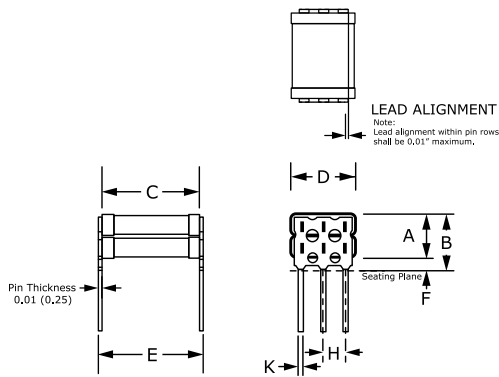

Dimensions	
D	6.35mm +/-0.635mm
L	6.35mm MIN
H	2.54mm NOM
F	1.397mm +/-0.25mm
A	5.3mm MAX
B	7.078mm MAX
C	6.35mm +/-0.635mm
E	7.62mm MAX
K	0.5mm NOM

Packaging Specifications	
Packaging:	Waffle, Box
Packaging Quantity:	50

General Information	
Series:	KPS-MCC Indust COG HT200C
Style:	Leaded Stacked Chip
Description:	Low ESR, Stacked Ceramic Chips
Features:	200C, Low ESR, High Thermal Stability, Bulk Capacitance
RoHS:	With Exemptions
REACH:	SVHC (Pb – CAS 7439-92-1)
SCIP Number:	297427bb-2a48-4853-b594-641304a2cc24
Termination:	Silver
Lead:	Straight Leads
AEC-Q200:	No
Notes:	Number of chips in this stack: 2.

Specifications	
Capacitance:	0.056 uF
Capacitance Tolerance:	10%
Voltage DC:	630 VDC
Dielectric Withstanding Voltage:	819 VDC
Temperature Range:	-55/+200°C
Temperature Coefficient:	COG
Dissipation Factor:	0.1% 1 kHz 25C
Aging Rate:	0% Loss/Decade Hour
Insulation Resistance:	17.86 GOhms