

規格承認書

PECIFICATION FOR APPROVAL

客戶
CUSTOMER : 立創
項目
ITEM : 电磁有源一体蜂鸣器 (内含驱动电路)
型號
TYPE : GMD12095YB-5V2400
描述
DESCRIPTION : $\phi 12 \times H9.5 \text{ mm}$ 2400Hz DC5V $\geq 85\text{dB}$ PPO 材质 P=7.6mm
客戶料號
CUSTOMER NO. :
規格書號
SPECIFICATION NO.:
版本
EDITION NO. : V1.0
日期
DATE : 2019-12-26

客戶承認

CUSTOMER CONFIRM AND SIGN

檢查 TESTED BY	審核 CHECKED BY	承認 APPROVED BY

東莞市贏海電子有限公司

DONGUAN INGHAI ELECTRONICS CO.,LTD

製作 ISSUED BY	審查 CHECKED BY	確認 APPROVED BY
周明	刘承成	

地址：廣東省東莞市長安鎮廈邊元灶頭工業區 16-6 號
電話 / TEL: 0769-83060958 傳真 / FAX: 0769-81608993
網址: HTTP://WWW.INGHAI.COM

DONGGUAN INGHAI ELECTRONICS CO.,LTD

Model NO: GMD12095YB-5V2400

A: DIMENSIONS: Unit:mm Tolerance: ± 0.2 mm

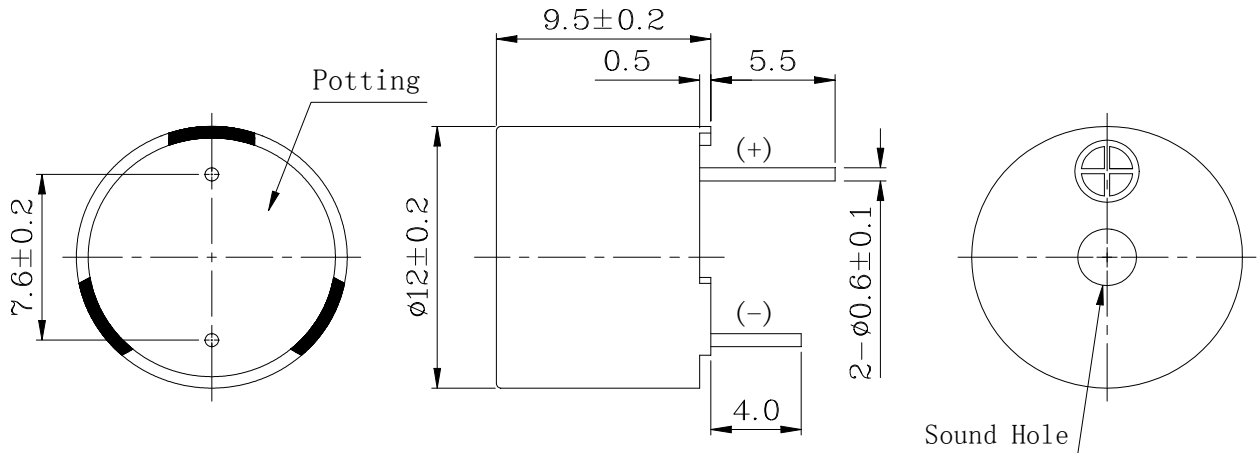

B: SPECIFICATIONS

Model NO	GMD12095YB
Rated Voltage	5VDC
Operating Voltage	3.0~7.0VDC
Max.Rated Current	Max.30mA
Sound Pressure level(dB/min)at5DVC/10cm	Min 85dB
Resonant Frequency	2400 ± 300 Hz
Operating Temperature	-20 °C~+70 °C
Storage Temperature	-30 °C~+80°C
Case material and color	PPO / Black

Measuring condition

Part shall be measured under a condition (Temperature: 5 ~ 35°C, Humidity: 45% ~ 85%R.H., Atmospheric pressure: 860 ~ 1060hPa) unless the standard condition (Temperature: 25 \pm 3°C, Humidity: 60 \pm 10%R.H. Atmospheric pressure: 860 ~ 1060hPa) is regulated to measure.

C: Acoustic Characteristics:

The oscillation frequency, current consumption and sound pressure are measured by the measuring instruments shown below

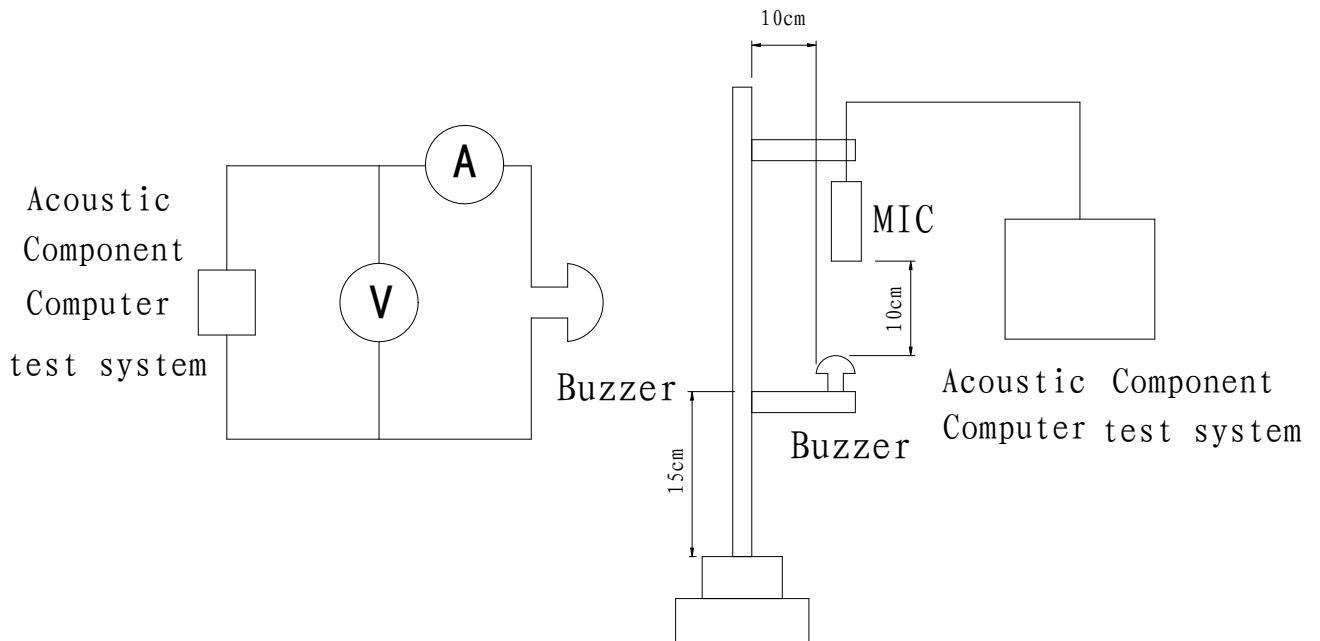

D: Typical Frequency Response Curve:

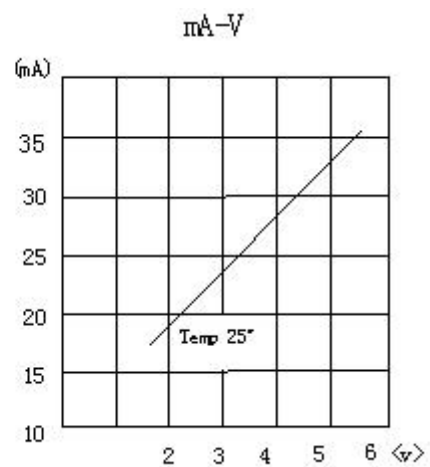
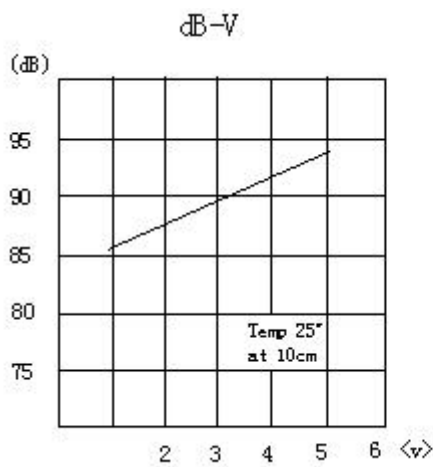

E: Reliability Test

After any following tests the part shall meet specifications without any degradation in appearance and performance except SPL. SPL shall not deviate more than -10 dB from the initial value

1. Ordinary Temperature Life Test

The part shall be subjected to 96 hours at $25 \pm 10^\circ\text{C}$. Input rated voltage Resonant frequency, 1/2 duty Square wave.

2. High Temperature Test

The part shall be capable of with standing a storage temperature of $+80^\circ\text{C}$ for 96 hours.

3. Low Temperature Test

The part shall be capable of with standing a storage temperature of -30°C for 96 hours.

4. Humidity Test

Temperature: $+40^\circ\text{C} \pm 3^\circ\text{C}$ Relative Humidity: 90% ~ 95% Duration: 48 hours and expose to room temperature for 6 hours

5. Temperature Shock Test

Temperature: 70°C /1hour → 25°C /3hours → -30°C /1hour → 25°C /3hours (1cycle)
Total cycle: 10 cycles

6. Drop Test

Standard Packaging From 120mm (Drop on hard wood or board of 5cm thick, three sides, six plain.)

7. Vibration Test

Vibration: 1000cycles /min. Amplitude: 1.5mm, Duration: 1 hour in each 3 axes

Note:

As this product is not protected from foreign material entering, please make sure that any foreign materials (e.g. magnetic powder, washing solvent, flux, corrosive gas) do not enter this product in your production processes. The functional degradation (e.g. SPL down) may occur if foreign material enter it.