



LUCKI CM ELECTRONICS Co.,Ltd



APPROVAL SHEET

Customer : _____
 Part Number: 2520 Seam Sealing Crystal
 LK Part No.: L225S260LH
 Holder : SMD 2520
 Frequency: 26.000MHZ 12PF ± 10PPM
 Manufacturer: Lucki Electronics
 Date: 2021-11-06

Prepared	Checked	Approved
Chen Mohan	Zhang Dongwei	Zhang Bin

(For Customer Use)

Acceptable	



LUCKI CM ELECTRONICS Co.,Ltd



Revision History

No.	Revised Date	Change Content	Approved	Remark



LUCKI CM ELECTRONICS Co.,Ltd



1. Electrical characteristics

Items	Symbol	Specification			Unit	Notes
		Min	Typ	Max		
Model No		Seam Seal 2520				
Blank Cutting Mode		AT FUND				
Nominal Frequency	F0	26.000000			MHz	
Oscillation Mode		■ Fundamental □3rd				
Frequency Tolerance	$\Delta F/F0$	-10		10	ppm	25°C ± 3°C
Load Capacitance	CL		12		pF	
Frequency Stability	TC	-15		15	ppm	
Operating Temperature	Topr	-40		85	°C	
Storage Temperature	Tstg	-55	~	125	°C	
Drive Level	DL		100	300	uW	
Effective Resistance RR	Rr	-	-	35	Ω	
Shunt Capacitance C0	C0	-	-	2	pF	
Trim Sensitivity TS	TS	-		-	ppm/PF	
Insulation Resistance	IR	500	-	-	MΩ	at DC 100 V
Aging:	Fa	-2		0	ppm	Per year
Weight			0.0125		g	

Remark: Sample Data See Attachment

Measure equipment :

Electrical characteristics measured by S&A 250B or equivalent.

Hermetically :

Fine Leak: Helium Bombing 4kg/cm² for 1 Hour, Leak ate Less Than ⁻⁸atm. cc/sec 1×10

Gross Leak: 125°C FC#40 , 120 Seconds, No Bubble



LUCKI CM ELECTRONICS Co.,Ltd



2.Solder Dimension And Pattern

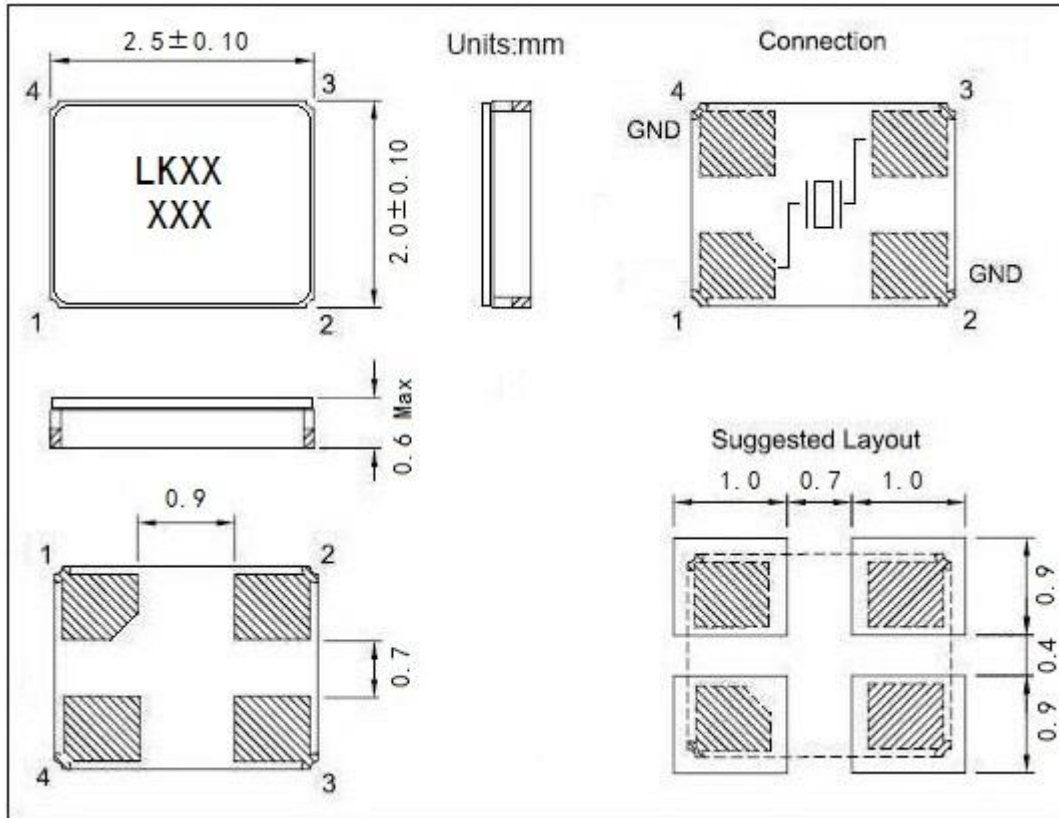

3. Equivalent Circuit

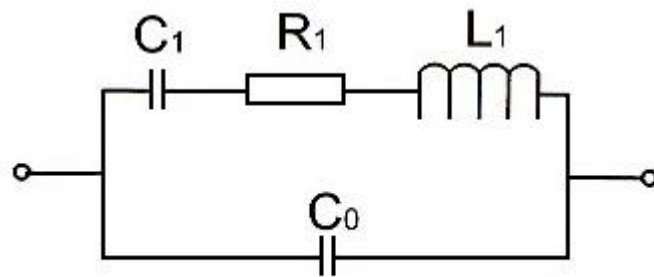

Equivalent Circuit

4. Structure drawing

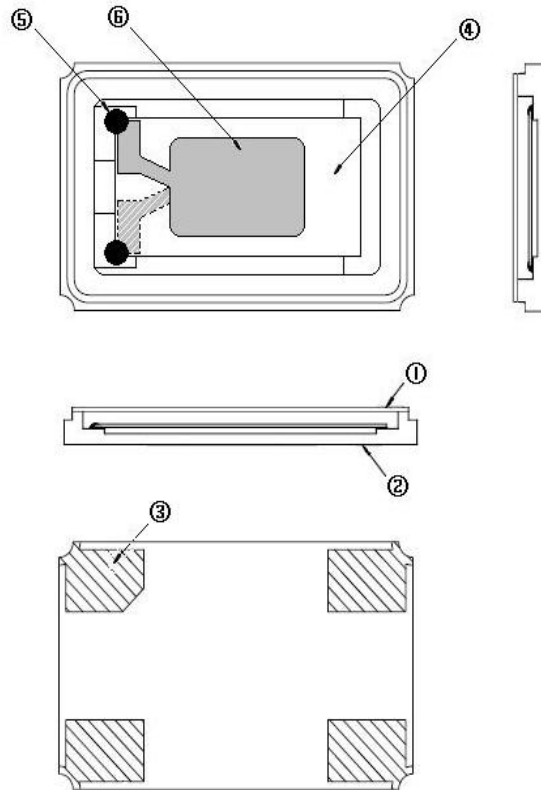

NO	COMPONENTS	MATERIALS	QTY	FINISH / SPECIFICATIONS
1	Cap	Metal (Fe)	1	-
2	Base	Ceramic	1	Color black
3	PAD	Au	4	Tungsten metalize + Ni plating + Au plating
4	Crystal Blank	SiO ₂	1	-
5	Conductive Adhesive	Ag	4	Silicone
6	Electrode	Ag + Cr	2	-



LUCKI CM ELECTRONICS Co.,Ltd



5. Reliability Specification

	Item	Condition	Standard
1.	Drop characteristics	Free drop from 75cm height on a hard wooden board for 3 times. (Board is thickness more than 30 mm.)	Frequency change: $\leq \pm 5\text{ppm}$ Rr as specification
2	Mechanical shock	Device are shocked to half sine wave (1000g) three mutually perpendicular axes each 3 times	Frequency change: $\leq \pm 5\text{ppm}$ Rr as specification
3.	Shake characteristics	Shake frequency 10~55Hz, cycle 1~2 minutes, swing 1.5mm, direction x/y/z, all 30 minutes, test after 1 hours.	Frequency change: $\leq \pm 5\text{ppm}$ Rr as specification
4.	Humidity characteristics	$+40 \pm 2^\circ\text{C}$ & 90%~95% R.H. 250 hours	Frequency change: $\leq \pm 5\text{ppm}$ Rr as specification
5.	Low temperature characteristics	$-40 \pm 2^\circ\text{C}$, 250 hours, put in room temperature, test after 1 hours.	Frequency change: $\leq \pm 5\text{ppm}$ Rr as specification
6.	High temperature characteristics	$+85 \pm 2^\circ\text{C}$, 250 hours, put in room temperature, test after 1 hours.	Frequency change: $\leq \pm 5\text{ppm}$ Rr as specification
7.	Temperature cycling	$-30 \pm 3^\circ\text{C}/30 \pm 3\text{ min}$ ~ $+85 \pm 2^\circ\text{C}/30 \pm 3\text{ min}$, 5 cycles	Frequency change: $\leq \pm 5\text{ppm}$ Rr as specification
8.	Reflux examination	<p>1- Max 180 sec 2- Max 10 sec 3- Max 80 sec 4- Max 90 sec</p>	Frequency change: $\leq \pm 5\text{ppm}$ Rr as specification



LUCKI CM ELECTRONICS Co.,Ltd



6. Marking specification

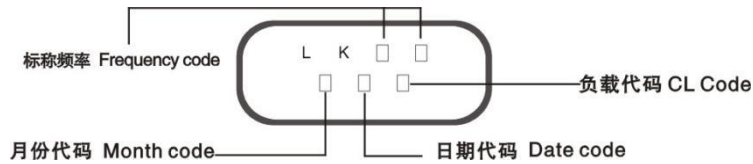

Produce Time Code

负载代码 CL Code

负载 CL	6	6.1~6.5	7.1~7.5	8	8.5	9	9.1~9.5	10	10.5	11.2	11.5	12	12.5
代码 Code	A	B	C	D	E	F	G	H	I	J	K	L	M

负载 CL	13	14	15	16	17	18	19	20	22	28	30		
代码 Code	N	O	P	Q	R	S	T	U	V	W	X	Y	Z

月份代码 Month code

月份 Month	1	2	3	4	5	6	7	8	9	10	11	12
代码 code	1	2	3	4	5	6	7	8	9	O	N	D

日期代码 Date code

日期 Date	1	2	3	4	5	6	7	8	9	10	11	12	13	14	15	16
代码 code	A	B	C	D	E	F	G	H	I	J	K	L	M	N	O	P

日期 Date	17	18	19	20	21	22	23	24	25	26	27	28	29	30	31
代码 code	Q	R	S	T	U	V	W	X	Y	Z	1	2	3	4	5



LUCKI CM ELECTRONICS Co.,Ltd



7. Type & Reel

	HC-49SMD	7050	6035	5032	3225	2520	2016
W	24.00±0.30	16.00±0.05	12.00±0.05	12.00±0.05	8.00±0.05	8.00±0.05	8.00±0.05
E	1.75±0.10	1.75±0.10	1.75±0.10	1.75±0.10	1.75±0.10	1.75±0.10	1.75±0.10
F	11.5±0.10	7.5±0.10	5.5±0.10	5.5±0.10	3.5±0.05	3.5±0.05	3.5±0.05
T	0.40±0.05	0.35±0.05	0.35±0.05	0.30±0.05	0.25±0.03	0.25±0.03	0.25±0.03
P	12.00±0.10	8.00±0.10	8.00±0.10	8.00±0.10	4.00±0.05	4.00±0.05	4.00±0.05
P0	4.00±0.10	4.00±0.10	4.00±0.10	4.00±0.10	4.00±0.05	4.00±0.05	4.00±0.05
P2	2.00±0.10	2.00±0.10	2.00±0.10	2.00±0.10	2.00±0.05	2.00±0.05	2.00±0.05
D0	φ1.50±0.10	φ1.50±0.10	φ1.50±0.10	φ1.50±0.10	φ1.50±0.10	φ1.50±0.10	φ1.50±0.10
D1	φ1.50MIN	φ1.50MIN	φ1.50MIN	φ1.50MIN	φ1.00MIN	φ1.00MIN	φ1.00MIN
A0	4.60±0.10	5.40±0.10	3.90±0.10	3.50±0.10	2.70±0.10	2.4±0.10	2.00±0.10
K0	4.40±0.10	1.80±0.10	1.50±0.10	1.60±0.10	1.50±0.10	1.10±0.10	1.10±0.10
B0	14.20±0.15	7.40±0.10	6.40±0.10	5.20±0.10	3.50±0.05	2.90±0.05	2.4±0.05





LUCKI CM ELECTRONICS Co.,Ltd



	HC-49SMD	7050	6035	5032	3225	2520	2016
A	$\phi 330 \pm 1.0$	$\phi 178 \pm 2.0$	$\phi 178 \pm 2.0$	$\phi 178 \pm 2.0$	$\phi 178 \pm 2.0$	$\phi 178 \pm 2.0$	$\phi 178 \pm 2.0$
B	2.30 ± 0.20	2.00 ± 0.50	2.00 ± 0.50	2.00 ± 0.50	2.50 ± 0.50	2.50 ± 0.50	2.50 ± 0.50
C	$\phi 13.5 \pm 0.20$	$\phi 13.2 \pm 0.20$	$\phi 13.2 \pm 0.20$	$\phi 13.2 \pm 0.20$	$\phi 13.5 \pm 0.20$	$\phi 13.5 \pm 0.20$	$\phi 13.5 \pm 0.20$
D	$\phi 21.5 \pm 0.20$	$\phi 20.0 \pm 0.50$	$\phi 20.0 \pm 0.50$	$\phi 20.0 \pm 0.50$	$\phi 56.8 \pm 0.50$	$\phi 56.8 \pm 0.50$	$\phi 56.8 \pm 0.50$
N	$\phi 100.0 \pm 0.5$	$\phi 60.5 \pm 1.0$	$\phi 60.5 \pm 1.0$	$\phi 60.5 \pm 1.0$	$\phi 60.5 \pm 1.0$	$\phi 60.5 \pm 1.0$	$\phi 60.5 \pm 1.0$
W I	24.5 ± 0.20	16.5 ± 0.20	12.5 ± 0.20	12.5 ± 0.20	9.4 ± 0.30	8.0 ± 0.30	8.0 ± 0.30
T1	2.30 ± 0.20	1.80 ± 0.20	1.80 ± 0.20	1.80 ± 0.20	1.40 ± 0.20	1.40 ± 0.20	1.40 ± 0.20

8. Packing Specification

