

SWITCHING DIODES

FEATURES

Fast Switching Speed
For General Purpose Switching Applications
High Conductance

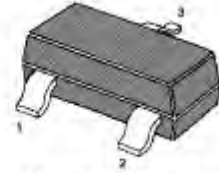
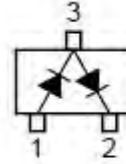

Marking Code: A7
SOT-23 Plastic Package

Absolute Maximum Ratings ($T_a = 25\text{ }^\circ\text{C}$)

Parameter	Symbol	Value	Unit	
Repetitive Peak Reverse Voltage	V_{RRM}	85	V	
Continuous Reverse Voltage	V_R	75	V	
Continuous Forward Current (Double Diode Loaded)	I_F	125	mA	
Continuous Forward Current (Single Diode Loaded)	I_F	215	mA	
Repetitive Peak Forward Current	I_{FRM}	450	mA	
Non-repetitive Peak Forward Surge Current	I_{FSM}	at $t = 1\text{ s}$ at $t = 1\text{ ms}$ at $t = 1\text{ }\mu\text{s}$	0.5 1 4.5	A
Power Dissipation		P_{tot}	350	mW
Junction Temperature		T_j	150	$^\circ\text{C}$
Storage Temperature Range	T_{stg}	- 65 to + 150	$^\circ\text{C}$	

Characteristics at $T_a = 25\text{ }^\circ\text{C}$

Parameter	Symbol	Max.	Unit		
Forward Voltage at $I_F = 1\text{ mA}$ at $I_F = 10\text{ mA}$ at $I_F = 50\text{ mA}$ at $I_F = 150\text{ mA}$	V_F	0.715 0.855 1 1.25	V		
Reverse Current at $V_R = 25\text{ V}$ at $V_R = 75\text{ V}$ at $V_R = 25\text{ V}, T_j = 150\text{ }^\circ\text{C}$ at $V_R = 75\text{ V}, T_j = 150\text{ }^\circ\text{C}$		I_R	30 1 30 50	nA μA μA μA	
Diode Capacitance at $V_R = 0, f = 1\text{ MHz}$			C_d	1.5	pF
Reverse Recovery Time at $I_F = I_R = 10\text{ mA}, I_R = 1\text{ mA}, R_L = 100\text{ }\Omega$			t_{rr}	4	ns

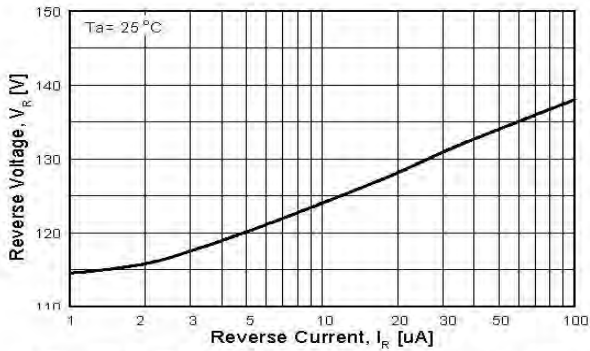

Figure 1. Reverse Voltage vs Reverse Current BV - 1.0 to 100uA

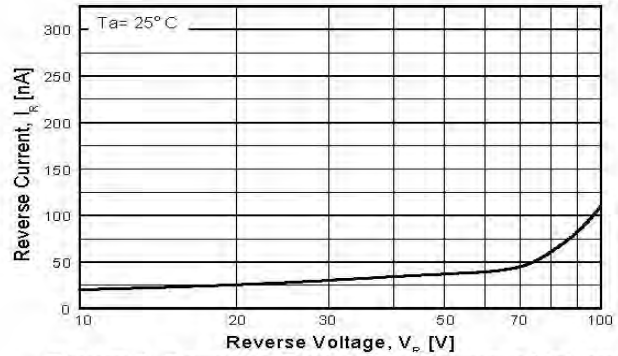

Figure 2. Reverse Current vs Reverse Voltage IR - 10 to 100 V

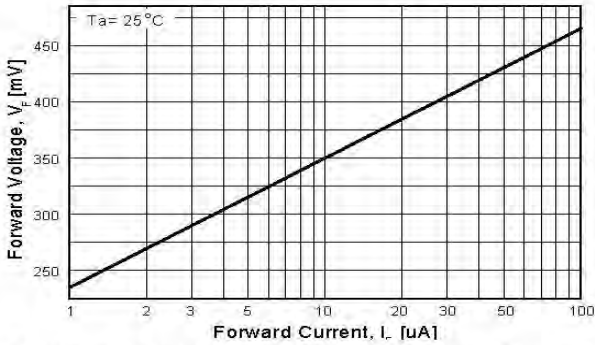

Figure 3. Forward Voltage vs Forward Current VF - 1.0 to 100 uA

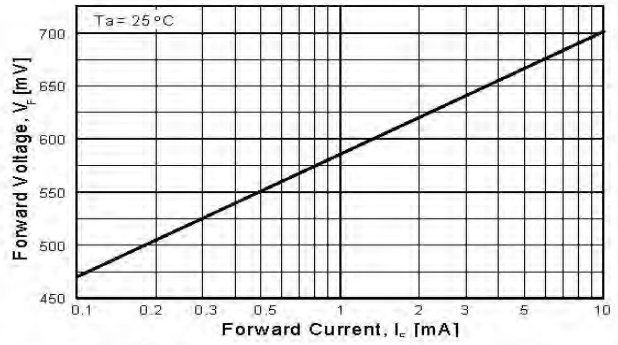

Figure 4. Forward Voltage vs Forward Current VF - 0.1 to 10 mA

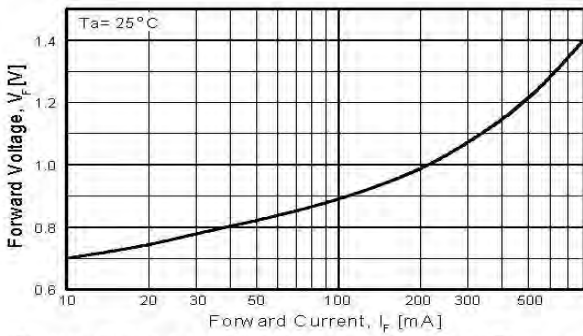

Figure 5. Forward Voltage vs Forward Current VF - 10 - 800 mA

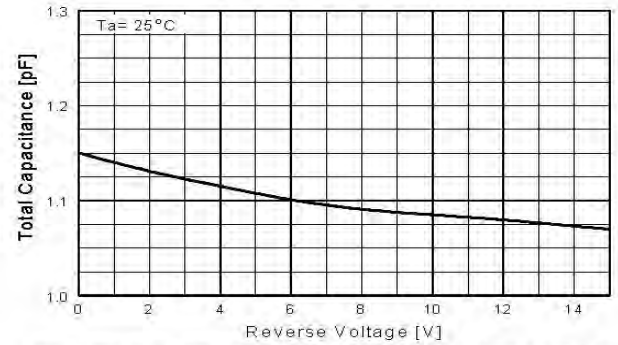

Figure 6. Total Capacitance vs Reverse Voltage

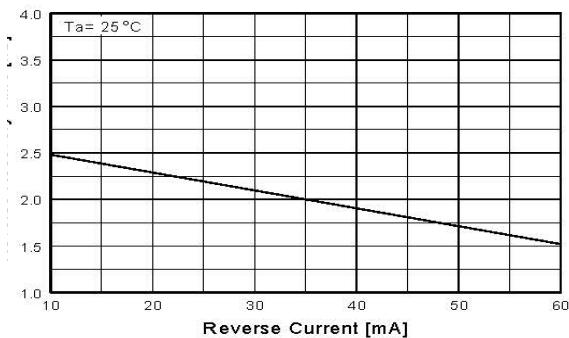

Figure 7. Reverse Recovery Time vs Reverse Current TRR - IR 10 mA vs 60 mA

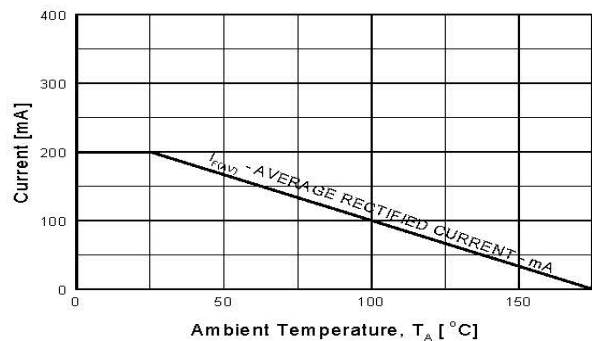

Figure 8. Average Rectified Current ($I_{F(AV)}$) versus Ambient Temperature (T_A)



PACKAGE OUTLINE

Plastic surface mounted package; 3 leads

SOT-23

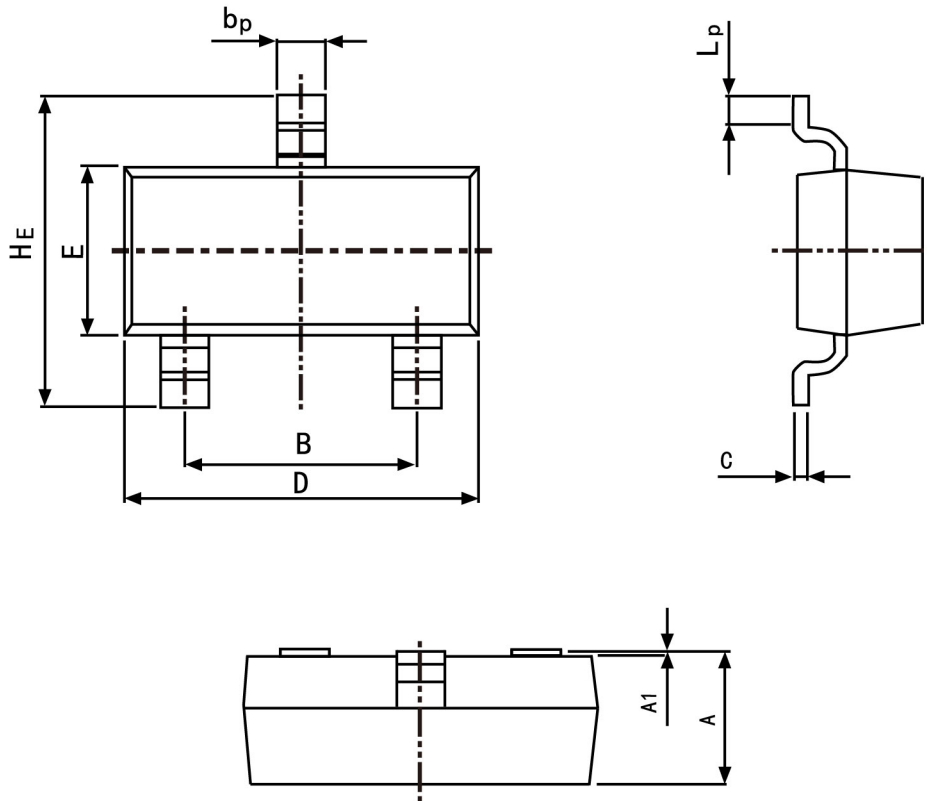

Symbol	Dimension in Millimeters	
	Min	Max
A	0.95	1.40
B	1.78	2.04
bp	0.35	0.50
C	0.08	0.19
D	2.70	3.10
E	1.20	1.65
HE	2.20	3.00
A1	0.100	0.013
Lp	0.20	0.50