

# MMBT3904 TRANSISTOR (NPN)

## FEATURES

Complementary Type The PNP Transistor MMBT3906 is Recommended  
Epitaxial Planar Die Construction

## MARKING: 1AM

### SOT-23

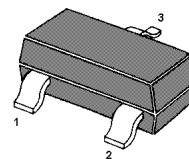

1. BASE
2. EMITTER
3. COLLECTOR

## MAXIMUM RATINGS (T<sub>a</sub>=25°C unless otherwise noted)

Symbol	Parameter	Value	Unit
V <sub>CBO</sub>	Collector-Base Voltage	60	V
V <sub>CEO</sub>	Collector-Emitter Voltage	40	V
V <sub>EBO</sub>	Emitter-Base Voltage	6	V
I <sub>C</sub>	Collector Current	200	mA
P <sub>C</sub>	Total Device Dissipation	200	mW
R <sub>θJA</sub>	Thermal Resistance From Junction to Ambient	625	°C/W
T <sub>J</sub>	Junction Temperature	150	°C
T <sub>stg</sub>	Storage Temperature	-55 ~ +150	°C

## ELECTRICAL CHARACTERISTICS (T<sub>a</sub>=25°C unless otherwise specified)

Parameter	Symbol	Test conditions	Min	Max	Unit
Collector-base breakdown voltage	V <sub>(BR)CBO</sub>	I <sub>C</sub> = 10μA, I <sub>E</sub> =0	60		V
Collector-emitter breakdown voltage	V <sub>(BR)CEO</sub>	I <sub>C</sub> = 1mA, I <sub>B</sub> =0	40		V
Emitter-base breakdown voltage	V <sub>(BR)EBO</sub>	I <sub>E</sub> =10μA, I <sub>C</sub> =0	6		V
Collector cut-off current	I <sub>CB0</sub>	V <sub>CB</sub> =60V, I <sub>E</sub> =0		0.1	μA
Collector cut-off current	I <sub>CEx</sub>	V <sub>CE</sub> =30V, V <sub>BE(off)</sub> =3V		50	nA
Emitter cut-off current	I <sub>EBO</sub>	V <sub>EB</sub> =5V, I <sub>C</sub> =0		0.1	μA
DC current gain	h <sub>FE(1)</sub>	V <sub>CE</sub> =1V, I <sub>C</sub> =10mA	100	300	
	h <sub>FE(2)</sub>	V <sub>CE</sub> =1V, I <sub>C</sub> = 50mA	60		
	h <sub>FE(3)</sub>	V <sub>CE</sub> =1V, I <sub>C</sub> = 100mA	30		
Collector-emitter saturation voltage	V <sub>CE(sat)</sub>	I <sub>C</sub> =50mA, I <sub>B</sub> = 5mA		0.3	V
Base-emitter saturation voltage	V <sub>BE(sat)</sub>	I <sub>C</sub> = 50mA, I <sub>B</sub> = 5mA		0.95	V
Transition frequency	f <sub>T</sub>	V <sub>CE</sub> =20V, I <sub>C</sub> =10mA, f=100MHz	300		MHz
Delay Time	t <sub>d</sub>	V <sub>CC</sub> =3V, V <sub>BE</sub> =-0.5V		35	nS
Rise Time	t <sub>r</sub>	I <sub>C</sub> =10mA, I <sub>B1</sub> =-I <sub>B2</sub> =1.0mA		35	nS
Storage Time	t <sub>s</sub>	V <sub>CC</sub> =3V, I <sub>C</sub> =10mA,		200	nS
Fall Time	t <sub>f</sub>	I <sub>B1</sub> =-I <sub>B2</sub> =1mA		50	nS



# Typical Characteristics

# MMBT3904

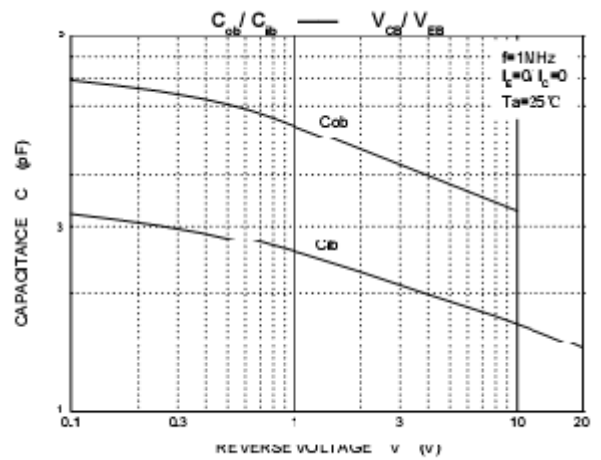
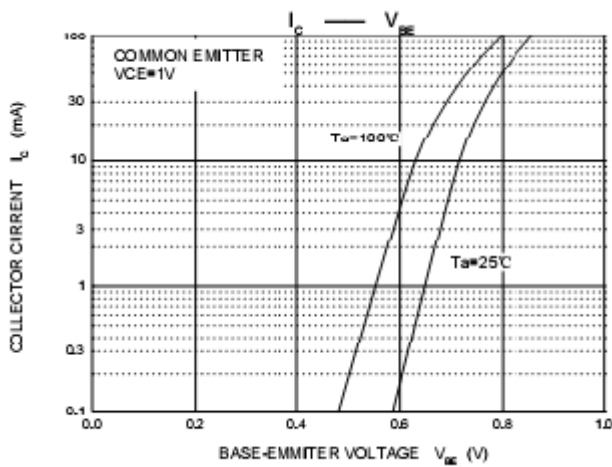
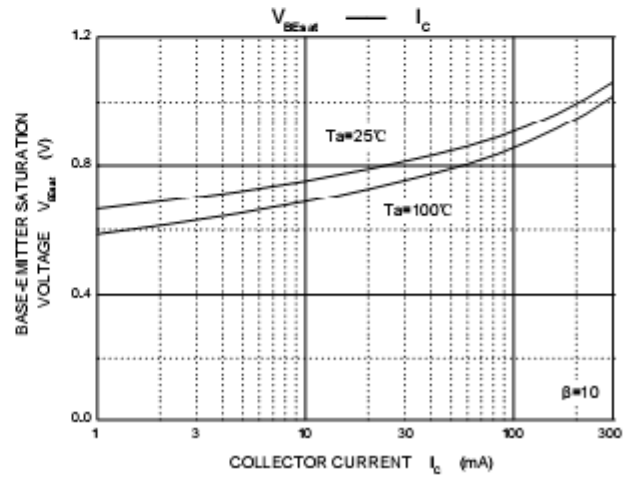
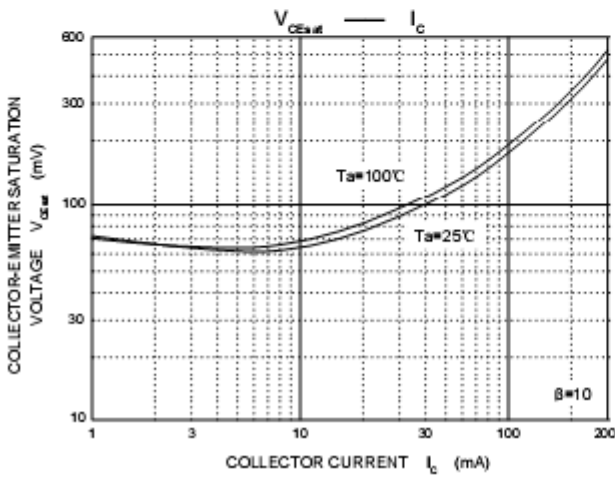
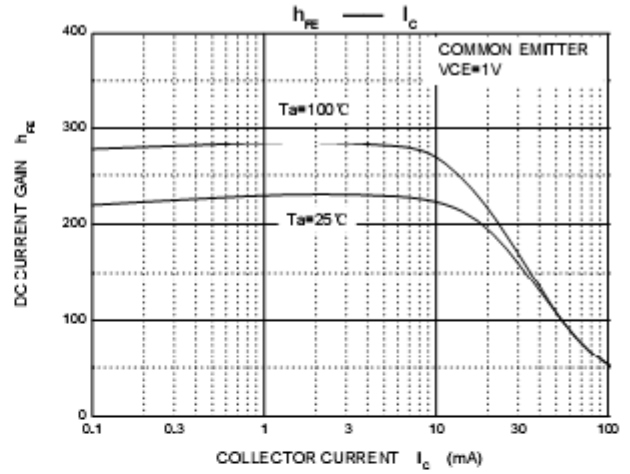
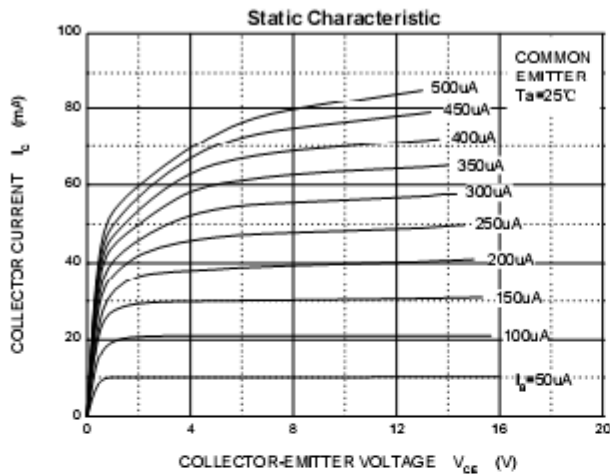

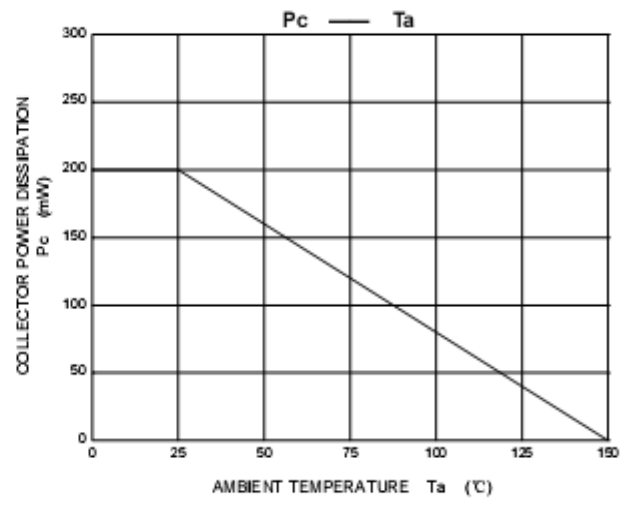
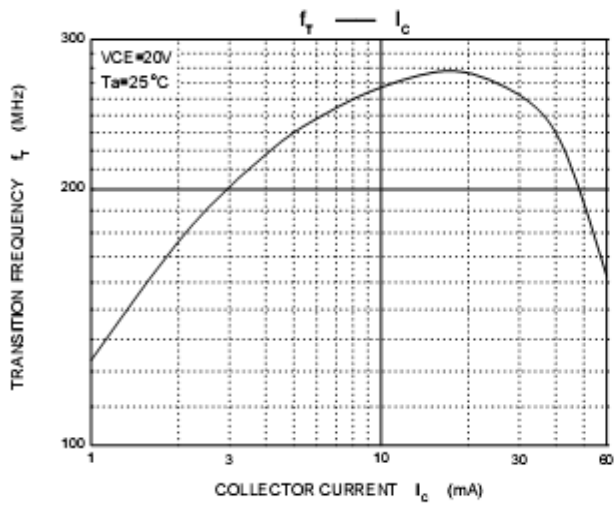



# PACKAGE OUTLINE

Plastic surface mounted package; 3 leads

SOT-23

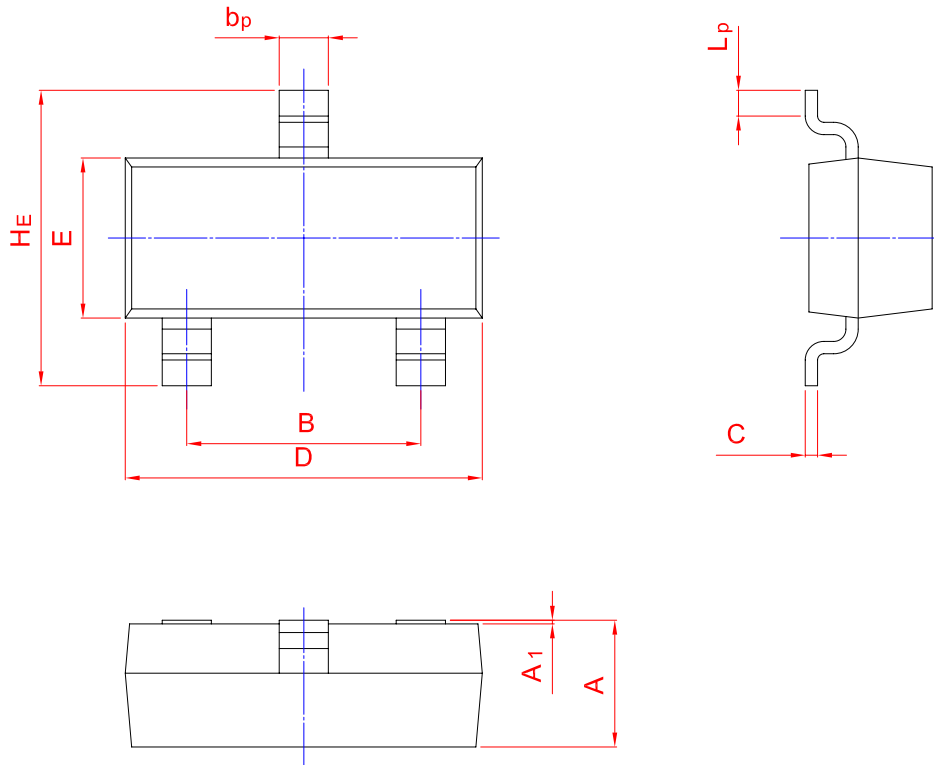
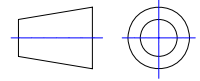

UNIT	A	B	bp	C	D	E	Hε	A1	Lp
mm	1.40	2.04	0.50	0.19	3.10	1.65	3.00	0.100	0.50
	0.95	1.78	0.35	0.08	2.70	1.20	2.20	0.013	0.20