

## REF34xx 低温漂、低功耗、小型串联电压基准

### 1 特性

- 初始精度： $\pm 0.05\%$  (最大值)
- 温度系数： $6\text{ppm}/^\circ\text{C}$  (最大值)
- 工作温度范围： $-40^\circ\text{C}$  至  $+125^\circ\text{C}$
- 输出电流： $\pm 10\text{mA}$
- 低静态电流： $95\ \mu\text{A}$  (最大值)
- 宽输入电压： $12\text{V}$
- 输出  $1/f$  噪声 ( $0.1\text{Hz}$  至  $10\text{Hz}$ )： $3.8\ \mu\text{V}_{\text{pp}}/\text{V}$
- 出色的长期稳定性 ( $25\text{ppm}/1000$  小时)
- 多个小型 6SOT-23 封装引脚排列：REF34xx 和 REF34xxT

### 2 应用

- 数据采集系统
- 模拟 I/O 模块
- 现场发送器
- 实验室和现场仪表
- 电池测试设备
- 直流电源、交流电源、电子负载
- 数字万用表

### 3 说明

REF34xx 器件是低温漂 ( $6\text{ppm}/^\circ\text{C}$ )、低功耗、高精度 CMOS 电压基准，具有  $\pm 0.05\%$  初始精度、低运行电流以及小于  $95\ \mu\text{A}$  的功耗。该器件还提供  $3.8\ \mu\text{V}_{\text{pp}}/\text{V}$  的超低输出噪声，这使得它在用于噪声关键型系统中的高分辨率数据转换器时能够保持较高的信号完整性。REF34xx 采用小型 SOT-23 封装，具有更高的规格参数并且能够以引脚对引脚方式替代 MAX607x 和 ADR34xx。REF34xx 系列与大多数 ADC 和 DAC 兼容，如 ADS1287、ADUCM360、ADS1112。

该器件的低输出电压迟滞和低长期输出电压漂移可进一步提高稳定性和系统可靠性。此外，器件的小尺寸和低运行电流 ( $95\ \mu\text{A}$ ) 特性使其非常适合便携式和电池供电应用。

REF34xx 具有  $-40^\circ\text{C}$  至  $+125^\circ\text{C}$  的较宽额定温度范围。

#### 器件信息(1)

器件名称	封装	封装尺寸 (标称值)
REF3425	SOT-23 (6)	2.90mm × 1.60mm
REF3430		
REF3433		
REF3440		
REF3450		

(1) 如需了解所有可用封装，请参阅数据表末尾的可订购产品附录

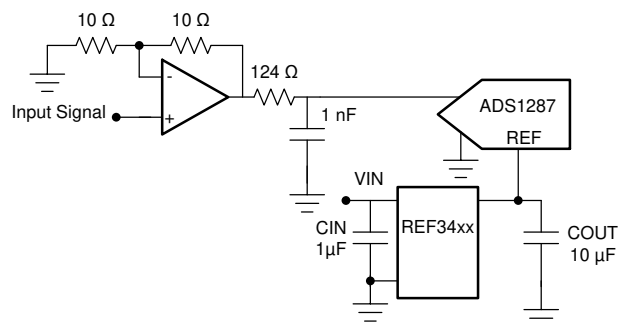

Copyright © 2017, Texas Instruments Incorporated

简化版原理图

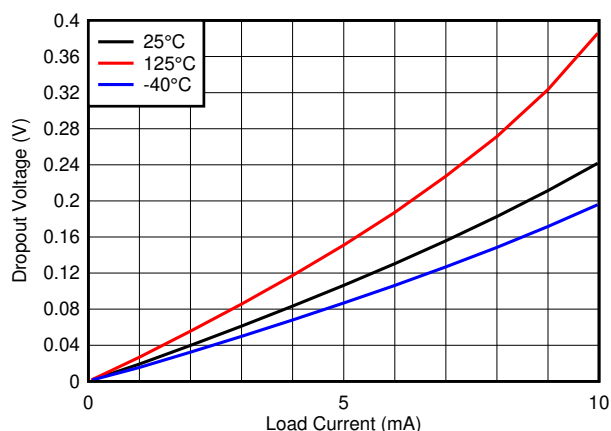

不同温度条件下压降与电流负载间的关系



## Table of Contents

<b>1 特性</b> .....	1	9.2 Functional Block Diagram.....	16
<b>2 应用</b> .....	1	9.3 Feature Description.....	16
<b>3 说明</b> .....	1	9.4 Device Functional Modes.....	17
<b>4 Revision History</b> .....	2	<b>10 Application and Implementation</b> .....	18
<b>5 Device Comparison Table</b> .....	4	10.1 Application Information.....	18
<b>6 Pin Configuration and Functions</b> .....	4	10.2 Typical Application: Basic Voltage Reference Connection.....	18
<b>7 Specifications</b> .....	5	<b>11 Power Supply Recommendations</b> .....	20
7.1 Absolute Maximum Ratings .....	5	<b>12 Layout</b> .....	21
7.2 ESD Ratings .....	5	12.1 Layout Guidelines.....	21
7.3 Recommended Operating Conditions .....	5	12.2 Layout Example.....	21
7.4 Thermal Information .....	5	<b>13 Device and Documentation Support</b> .....	22
7.5 Electrical Characteristics .....	6	13.1 Documentation Support.....	22
7.6 Typical Characteristics.....	8	13.2 接收文档更新通知.....	22
<b>8 Parameter Measurement Information</b> .....	12	13.3 支持资源.....	22
8.1 Solder Heat Shift.....	12	13.4 Trademarks.....	22
8.2 Long-Term Stability.....	13	13.5 静电放电警告.....	22
8.3 Thermal Hysteresis.....	13	13.6 术语表.....	22
8.4 Power Dissipation.....	14	<b>14 Mechanical, Packaging, and Orderable Information</b> .....	22
8.5 Noise Performance.....	15		
<b>9 Detailed Description</b> .....	16		
9.1 Overview.....	16		

## 4 Revision History

注：以前版本的页码可能与当前版本的页码不同

Changes from Revision D (February 2021) to Revision E (April 2021)	Page
• Removed the "Product Preview" note for the REF34xxT package options.....	4

Changes from Revision C (January 2021) to Revision D (February 2021)	Page
• 更新了说明和图.....	1
• 将 ENABLE 更改为 EN.....	1
• Updated values.....	12

Changes from Revision B (March 2018) to Revision C (February 2021)	Page
• 添加了“器件信息”以添加 REF34xxT.....	1
• 添加了指向“应用”的超链接.....	1
• 通篇将“V <sub>REF</sub> ”更改为“V <sub>OUT</sub> ”.....	1
• 更新了整个文档中的表格、图和交叉参考的编号格式.....	1
• Added REF34xxT to "Device Comparison Table".....	4
• Added REF34xxT to "Pin Configuration and Functions".....	4
• Fixed pinout numbering.....	4
• Added Configuration Information to "Electrical Characteristics” .....	5
• Changed ABS MAX IN MIN to "-0.3V".....	5
• Added REF34xxT to "Layout Guidelines" and "Layout Example".....	21

Changes from Revision A (December 2017) to Revision B (March 2018)	Page
• 添加了 2 个新 GPN : REF3440 和 REF3450.....	1

- 在 [节 1](#) 中将“出色的长期稳定性 ( 30ppm/1000 小时 ) ”更改为“出色的长期稳定性 ( 25ppm/1000 小时 ) ” **1**
- Changed "...typical drift value for the REF34xx is 30 ppm from 0 to 1000 hours" to "...typical drift value for the REF34xx is 25 ppm from 0 to 1000 hours" and changed [图 8-3](#) in [节 8.2](#) ..... **13**
- Changed "(as shown in Figure 26)" to " as shown in [图 9-1](#) in last paragraph of [节 10.2.2.2](#) ..... **19**

---

**Changes from Revision \* (September 2017) to Revision A (December 2017) Page**

---

- 添加了 2 款全新输出电压选项器件 REF3430 和 REF3433 的产品发布..... **1**
-

## 5 Device Comparison Table

PRODUCT		V <sub>OUT</sub>
REF3425	REF3425T	2.5 V
REF3430	REF3430T	3 V
REF3433	REF3433T	3.3 V
REF3440	REF3440T	4.096 V
REF3450	REF3450T	5 V

## 6 Pin Configuration and Functions



图 6-1. REF34xx, DBV Package, 6-Pin SOT-23, Top View



图 6-2. REF34xxT, DBV Package, 6-Pin SOT-23, Top View

表 6-1. Pin Functions

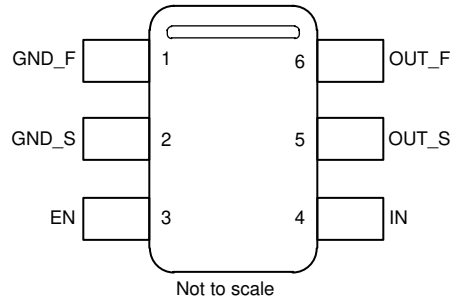
NAME	PIN		TYPE	DESCRIPTION
	REF34xx (DBV)	REF34xxT (DBV)		
GND_F	1		Ground	Ground force connection.
GND_S	2		Ground	Ground sense connection.
GND		2	Ground	Device ground.
EN	3		Input	Enable connection. Enables or disables the device.
IN	4	4	Power	Input supply voltage connection.
OUT_S	5		Input	Reference voltage output sense connection.
OUT_F	6		Output	Reference voltage output force connection.
VOUT		6	Output	Reference voltage output connection.
NC		1,3,5	-	Not connected. Pin can be left floating or connected to voltage within device operating range.

## 7 Specifications

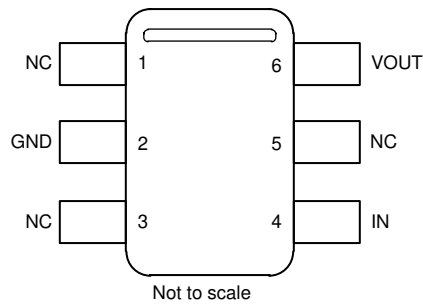
### 7.1 Absolute Maximum Ratings

over operating free-air temperature range (unless otherwise noted)<sup>(1)</sup>

		MIN	MAX	UNIT
Input voltage	IN	- 0.3	13	V
	EN	- 0.3	IN + 0.3	V
Output voltage	V <sub>OUT</sub>	- 0.3	5.5	V
Output short circuit current	I <sub>SC</sub>		20	mA
Operating temperature range	T <sub>A</sub>	- 55	150	°C
Storage temperature range	T <sub>stg</sub>	- 65	170	°C

- (1) Stresses above these ratings may cause permanent damage. Exposure to absolute maximum conditions for extended periods may degrade device reliability. These are stress ratings only, and functional operation of the device at these or any other conditions beyond those specified is not implied. These are stress ratings only and functional operation of the device at these or any other conditions beyond those specified in the Electrical Characteristics Table is not implied.

### 7.2 ESD Ratings

			VALUE	UNIT
V <sub>(ESD)</sub>	Electrostatic discharge	Human-body model (HBM), per ANSI/ESDA/ JEDEC JS-001 <sup>(1)</sup>	±2500	V
		Charged-device model (CDM), per JEDEC specification JESD22-C101 <sup>(2)</sup>	±1500	

- (1) JEDEC document JEP155 states that 500-V HBM allows safe manufacturing with a standard ESD control process.  
(2) JEDEC document JEP157 states that 250-V CDM allows safe manufacturing with a standard ESD control process.

### 7.3 Recommended Operating Conditions

over operating free-air temperature range (unless otherwise noted)

		MIN	NOM	MAX	UNIT
IN	Input Voltage	V <sub>OUT</sub> + V <sub>DO</sub> <sup>(1)</sup>		12	V
EN	Enable Voltage	0		IN	V
I <sub>L</sub>	Output Current	- 10		10	mA
T <sub>A</sub>	Operating Temperature	- 40	25	125	°C

- (1) V<sub>DO</sub> = Dropout voltage

### 7.4 Thermal Information

THERMAL METRIC(1)		REF34T	REF34	UNIT
		DBV	DBV	
		6 PINS	6 PINS	
R <sub>θJA</sub>	Junction-to-ambient thermal resistance	185	185	°C/W
R <sub>θJC(top)</sub>	Junction-to-case (top) thermal resistance	156	156	°C/W
R <sub>θJB</sub>	Junction-to-board thermal resistance	29.6	29.6	°C/W
Ψ <sub>JT</sub>	Junction-to-top characterization parameter	33.8	33.8	°C/W
Ψ <sub>JB</sub>	Junction-to-board characterization parameter	29.1	29.1	°C/W
R <sub>θJC(bot)</sub>	Junction-to-case (bottom) thermal resistance	N/A	N/A	°C/W

## 7.5 Electrical Characteristics

At  $V_{IN} = V_{OUT} + V_{DO}$ ,  $C_{OUT} = 10 \mu\text{F}$ ,  $C_{IN} = 0.1 \mu\text{F}$ ,  $I_L = 0 \text{ mA}$ , minimum and maximum specifications at  $T_A = -40^\circ\text{C}$  to  $125^\circ\text{C}$ ; Typical specifications at  $T_A = 25^\circ\text{C}$  unless otherwise noted

PARAMETER	TEST CONDITION		MIN	TYP	MAX	UNIT
<b>ACCURACY AND DRIFT</b>						
	Output voltage accuracy	$T_A = 25^\circ\text{C}$	- 0.05		0.05	%
	Output voltage temperature coefficient (1)	$-40^\circ\text{C} \leq T_A \leq 125^\circ\text{C}$		2.5	6	ppm/ $^\circ\text{C}$
<b>LINE &amp; LOAD REGULATION</b>						
$\Delta V_O / \Delta V_{IN}$	Line Regulation	$V_{IN} = V_{OUT} + V_{DO}$ (2) to 12 V		2	15	ppm/V
$\Delta V_O / \Delta I_L$	Load Regulation	$I_L = 0 \text{ mA to } 10 \text{ mA}$ , $V_{IN} = V_{OUT} + V_{DO}$ (3)	Sourcing	20	30	ppm/mA
			Sinking, REF3425	40	70	
		$I_L = 0 \text{ mA to } -10 \text{ mA}$ , $V_{IN} = V_{OUT} + V_{DO}$ , $T_A = 25^\circ\text{C}$ (3)	Sinking, REF3430	43	75	
			Sinking, REF3433	48	84	
			Sinking, REF3440	60	98	
Sinking, REF3450	70	140				
$I_{SC}$	Short circuit current	$V_{OUT} = 0 \text{ V}$ at $T_A = 25^\circ\text{C}$		18	22	mA
<b>NOISE</b>						
$e_{np-p}$	Low frequency noise (4)	$0.1 \text{ Hz} \leq f \leq 10 \text{ Hz}$		5		$\mu\text{V}_{p-p}/\text{V}$
		$0.1 \text{ Hz} \leq f \leq 10 \text{ Hz}$ (REF3440 and REF3450)		3.8		
$e_n$	Integrated wide band noise	$10 \text{ Hz} \leq f \leq 10 \text{ kHz}$		24		$\mu\text{V}_{rms}$
$e_n$	Output voltage noise density	$f = 1 \text{ kHz}$		0.25		ppm/ $\sqrt{\text{Hz}}$
		$f = 1 \text{ kHz}$ (REF3440 and REF3450)		0.2		
<b>LONG TERM STABILITY AND HYSTERESIS</b>						
	Long-term stability (5)	DBV Package	0 to 1000h at $35^\circ\text{C}$		25	ppm
			1000h to 2000h at $35^\circ\text{C}$		10	
	Output voltage thermal hysteresis (6)	DBV Package	$25^\circ\text{C}$ , $-40^\circ\text{C}$ , $125^\circ\text{C}$ , $25^\circ\text{C}$ Cycle 1		30	ppm
			$25^\circ\text{C}$ , $-40^\circ\text{C}$ , $125^\circ\text{C}$ , $25^\circ\text{C}$ Cycle 2		10	
<b>TURN-ON TIME</b>						
$t_{ON}$	Turn-on time	0.1% of output voltage settling, $C_L = 10 \mu\text{F}$		2.5		ms
<b>CAPACITIVE LOAD</b>						
$C_L$	Stable output capacitor range	$-40^\circ\text{C} \leq T_A \leq 125^\circ\text{C}$		0.1	10	$\mu\text{F}$
<b>OUTPUT VOLTAGE</b>						
<b>POWER SUPPLY</b>						
$V_{IN}$	Input voltage		$V_{OUT} + V_{DO}$		12	V
$I_L$	Output current capacity	$V_{IN} = V_{OUT} + V_{DO}$ to 12 V	- 10		10	mA
$I_Q$	Quiescent current	Active mode		72	95	$\mu\text{A}$
		Shutdown mode		2.5	3	
$V_{EN}$	ENABLE pin voltage	Voltage reference in active mode (EN = 1)	1.6			V
		Voltage reference in shutdown mode (EN = 0)			0.5	

## 7.5 Electrical Characteristics (continued)

At  $V_{IN} = V_{OUT} + V_{DO}$ ,  $C_{OUT} = 10 \mu\text{F}$ ,  $C_{IN} = 0.1 \mu\text{F}$ ,  $I_L = 0 \text{ mA}$ , minimum and maximum specifications at  $T_A = -40^\circ\text{C}$  to  $125^\circ\text{C}$ ;  
 Typical specifications at  $T_A = 25^\circ\text{C}$  unless otherwise noted

PARAMETER		TEST CONDITION	MIN	TYP	MAX	UNIT
$V_{DO}$	Dropout voltage	$I_L = 0 \text{ mA}$		50	100	mV
		$I_L = 10 \text{ mA}$			500	
$I_{EN}$	ENABLE pin leakage current	$V_{EN} = V_{IN} = 12\text{V}$		1	2	$\mu\text{A}$

- (1) Temperature drift is specified according to the box method. See Low Temperature Drift section for more details.
- (2)  $V_{DO}$  for line regulation test is 50 mV.
- (3)  $V_{DO}$  for load regulation test is 500 mV.
- (4) The peak-to-peak noise measurement is explained in more detail in section Noise Performance.
- (5) Long-term stability measurement procedure is explained in more detail in section Long - Term Stability.
- (6) Thermal hysteresis measurement procedure is explained in more detail in section Thermal Hysteresis.

## 7.6 Typical Characteristics

at  $T_A = 25^\circ\text{C}$ ,  $V_{IN} = V_{EN} = 12\text{ V}$ ,  $I_L = 0\text{ mA}$ ,  $C_L = 10\text{ }\mu\text{F}$ ,  $C_{IN} = 0.1\text{ }\mu\text{F}$  (unless otherwise noted)



图 7-1. Temperature Drift



图 7-2.  $V_{IN}$  vs  $I_Q$  over Temperature

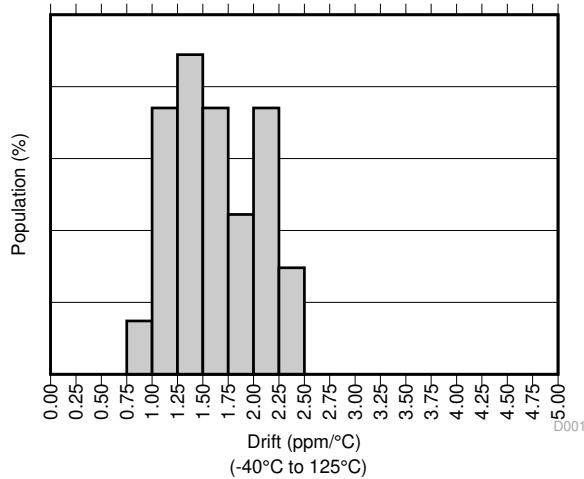

图 7-3. Output Voltage Accuracy vs Temperature

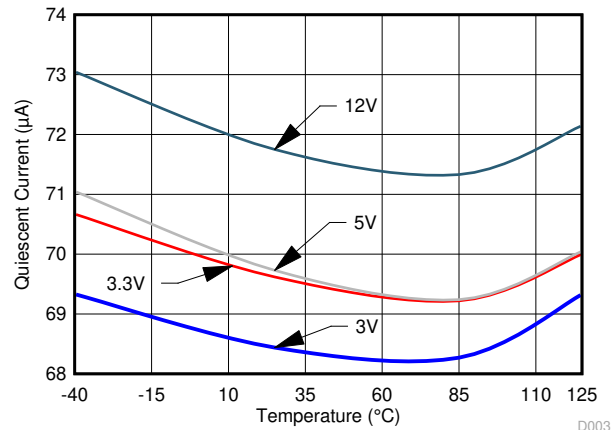

图 7-4. Quiescent Current vs Temperature

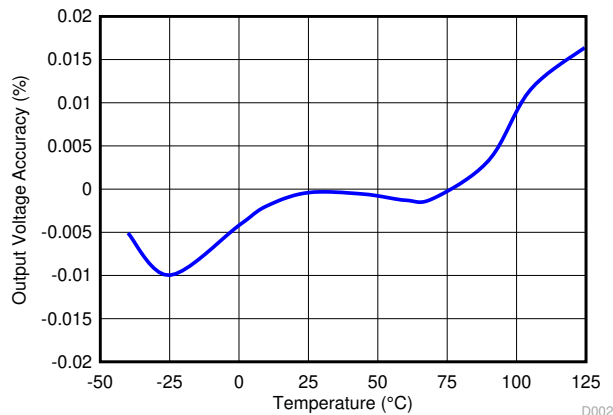

图 7-5. Power-Supply Rejection Ratio vs Frequency

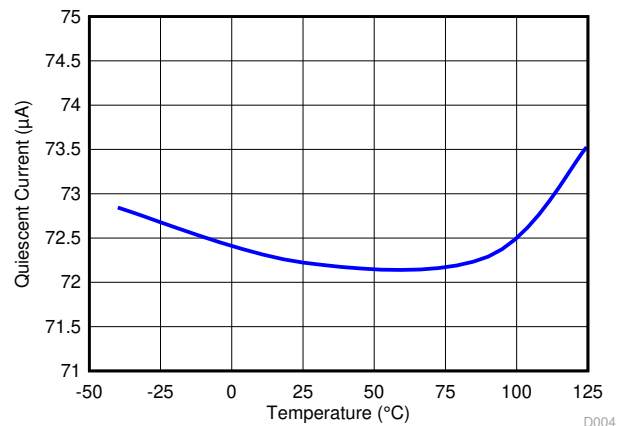

图 7-6. Line Regulation

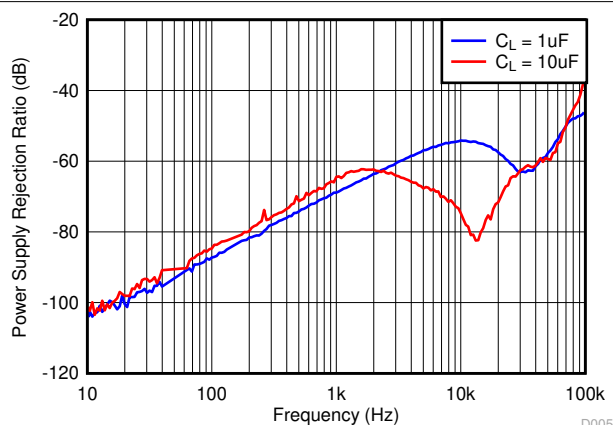

## 7.6 Typical Characteristics (continued)

at  $T_A = 25^\circ\text{C}$ ,  $V_{IN} = V_{EN} = 12\text{ V}$ ,  $I_L = 0\text{ mA}$ ,  $C_L = 10\ \mu\text{F}$ ,  $C_{IN} = 0.1\ \mu\text{F}$  (unless otherwise noted)

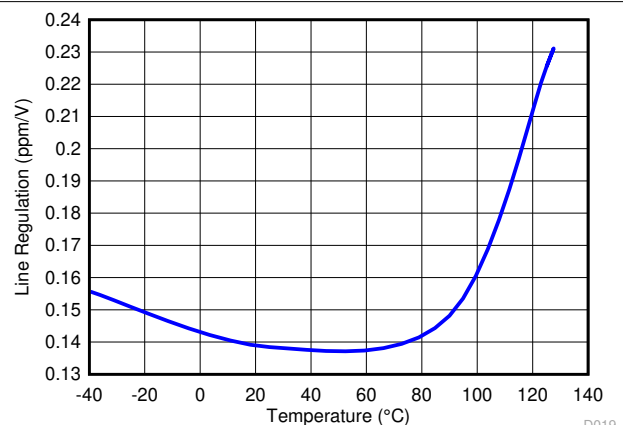

图 7-7. Load Regulation Sourcing



图 7-8. Load Regulation Sinking

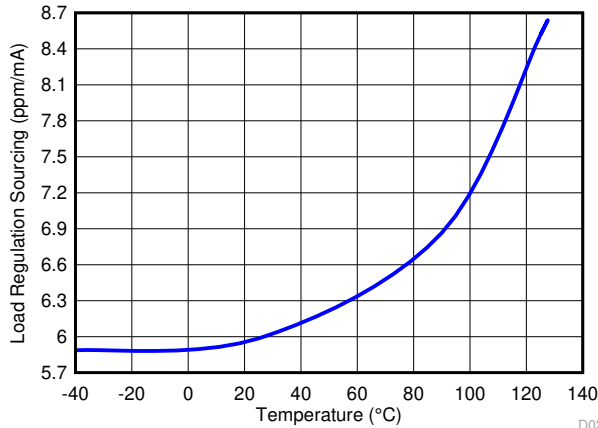

图 7-9. Noise Performance 10 Hz to 10 kHz

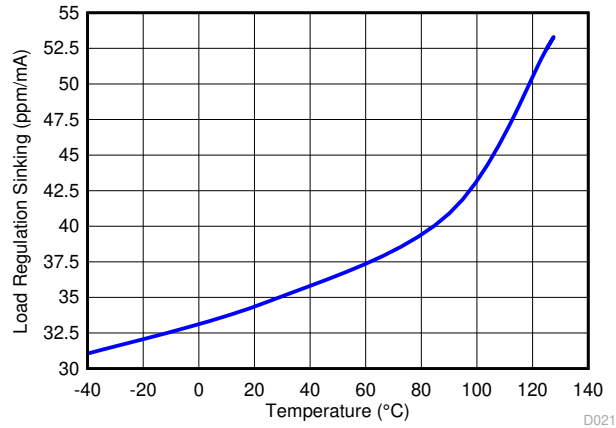

图 7-10. Load Transient

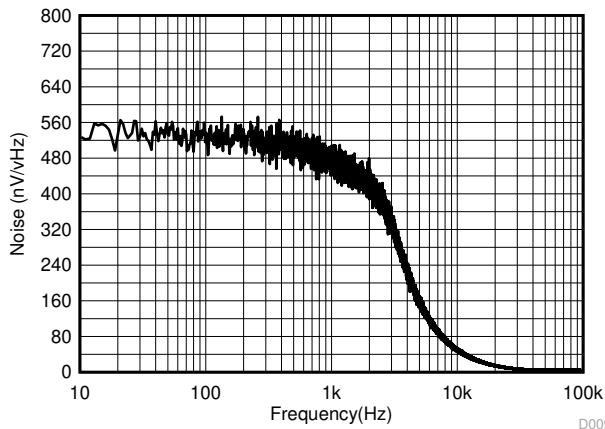

图 7-11. Load Transient

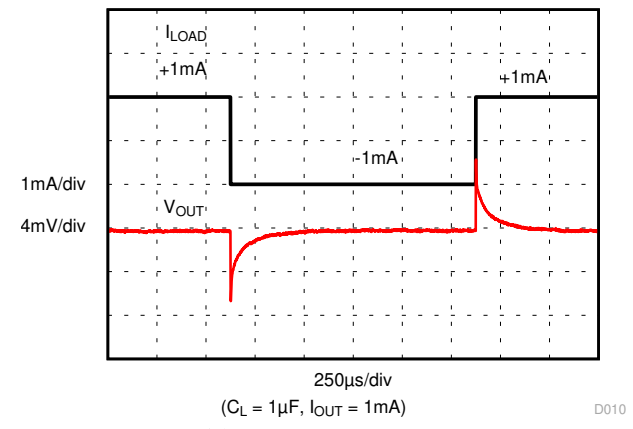

图 7-12. Load Transient

## 7.6 Typical Characteristics (continued)

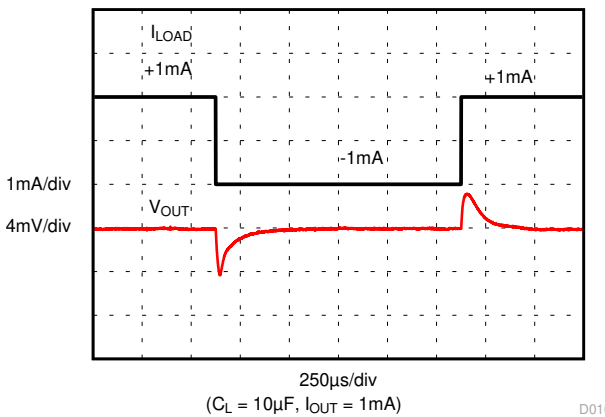
at  $T_A = 25^\circ\text{C}$ ,  $V_{IN} = V_{EN} = 12\text{ V}$ ,  $I_L = 0\text{ mA}$ ,  $C_L = 10\ \mu\text{F}$ ,  $C_{IN} = 0.1\ \mu\text{F}$  (unless otherwise noted)

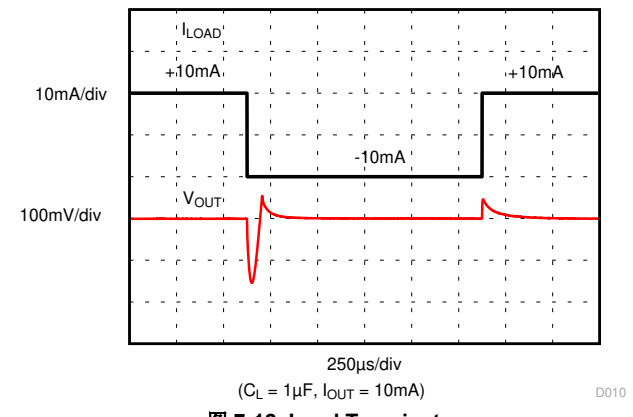
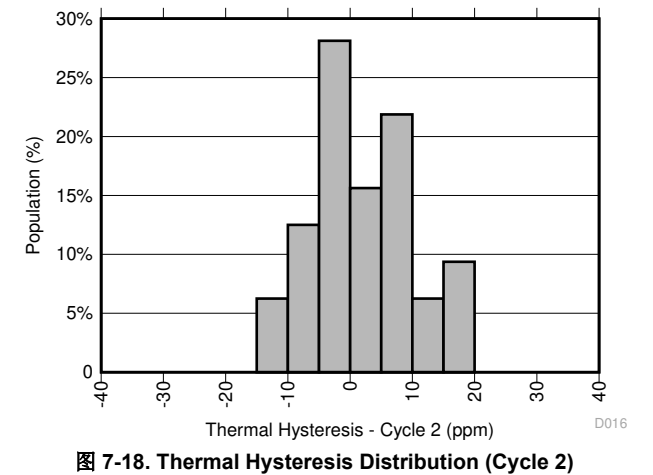
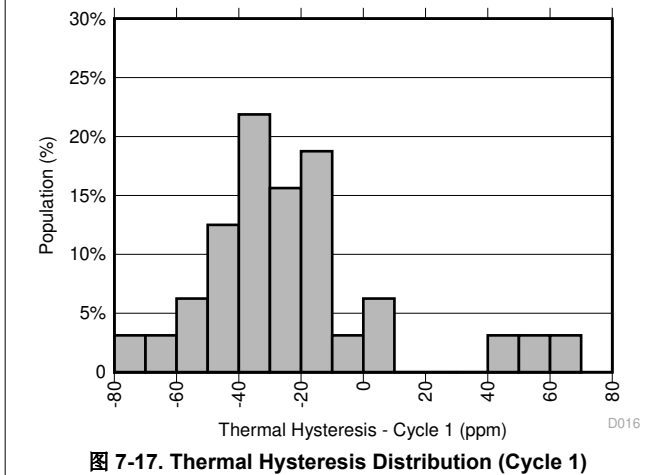
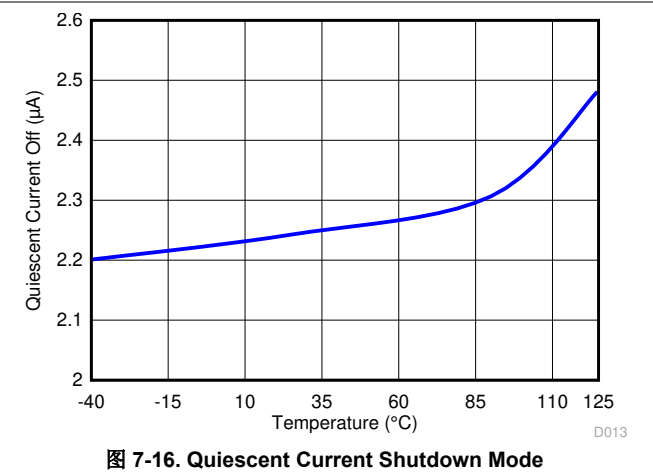
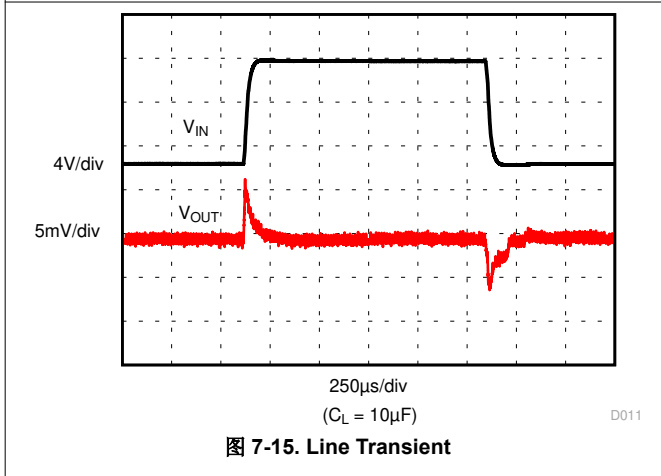
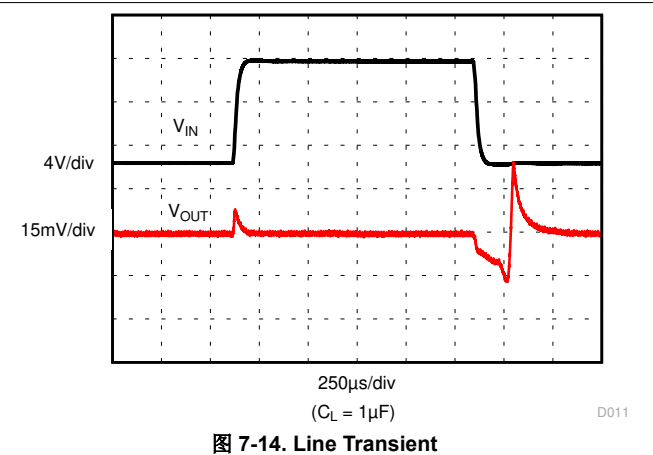
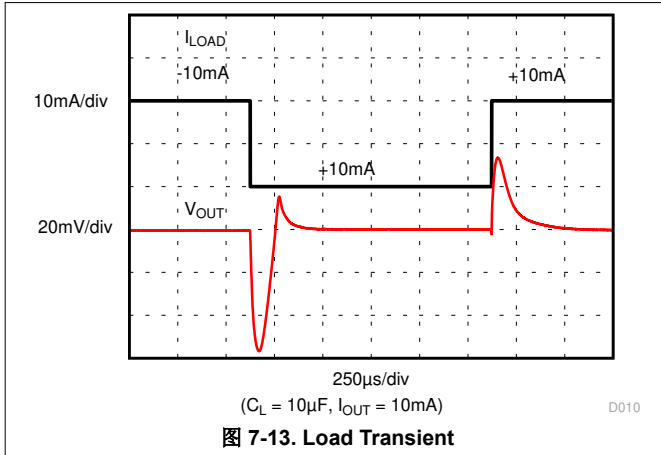

## 7.6 Typical Characteristics (continued)

at  $T_A = 25^\circ\text{C}$ ,  $V_{IN} = V_{EN} = 12\text{ V}$ ,  $I_L = 0\text{ mA}$ ,  $C_L = 10\text{ }\mu\text{F}$ ,  $C_{IN} = 0.1\text{ }\mu\text{F}$  (unless otherwise noted)

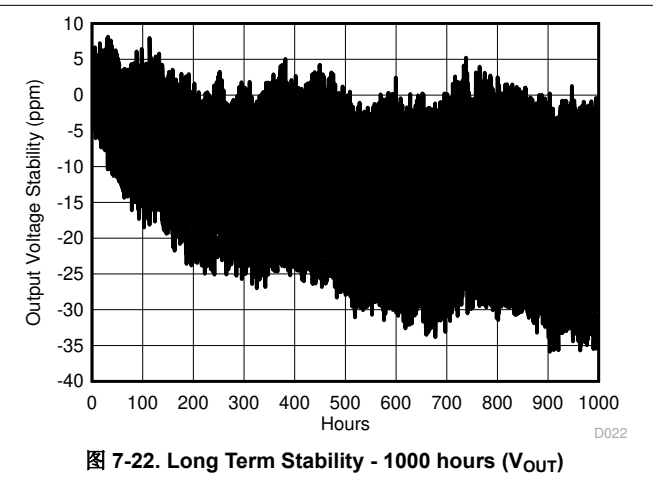
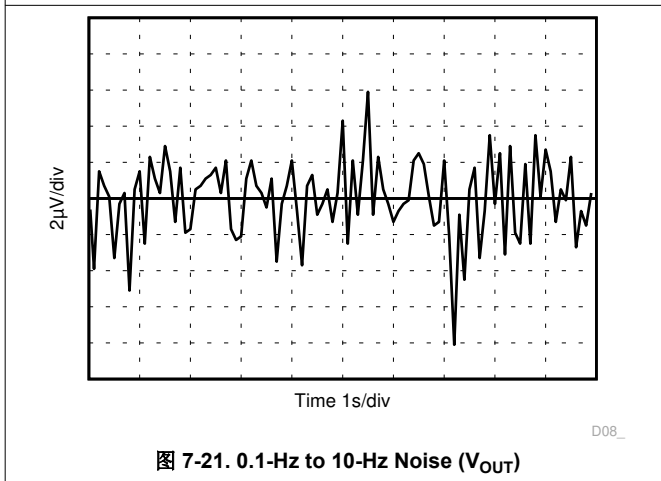
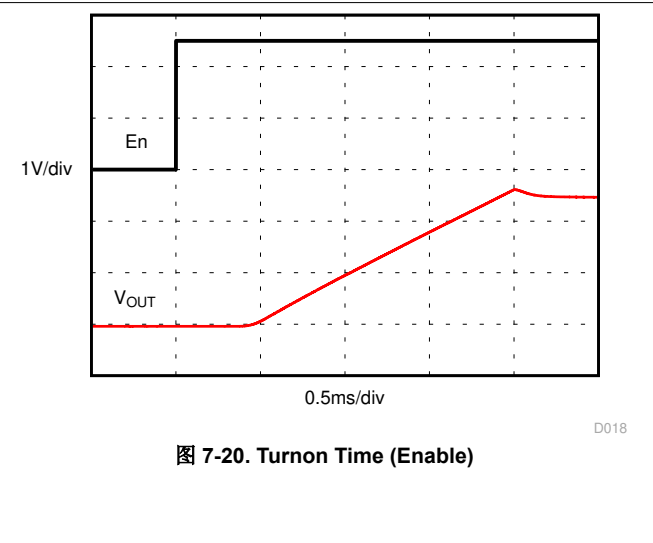

## 8 Parameter Measurement Information

### 8.1 Solder Heat Shift

The materials used in the manufacture of the REF34xx have differing coefficients of thermal expansion, resulting in stress on the device die when the part is heated. Mechanical and thermal stress on the device die can cause the output voltages to shift, degrading the initial accuracy specifications of the product. Reflow soldering is a common cause of this error.

In order to illustrate this effect, a total of 32 devices were soldered on 2 printed circuit boards [16 devices on each printed circuit board (PCB)] using lead-free solder paste and the paste manufacturer suggested reflow profile. The reflow profile is as shown in [Figure 8-1](#). The printed circuit board is comprised of FR4 material. The board thickness is 1.65 mm and the area is 114 mm × 152 mm.



图 8-1. Reflow Profile

The reference output voltage is measured before and after the reflow process; the typical shift is displayed in [Figure 8-2](#). Although all tested units exhibit very low shifts (< 0.01%), higher shifts are also possible depending on the size, thickness, and material of the printed circuit board. An important note is that the histograms display the typical shift for exposure to a single reflow profile. Exposure to multiple reflows, as is common on PCBs with surface-mount components on both sides, causes additional shifts in the output bias voltage. If the PCB is exposed to multiple reflows, the device must be soldered in the last pass to minimize its exposure to thermal stress.

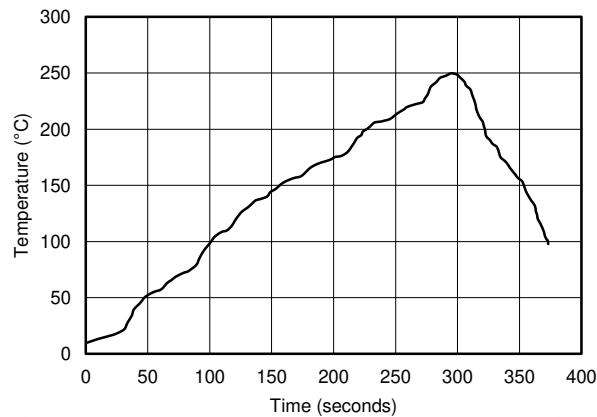

图 8-2. Solder Heat Shift Distribution,  $V_{OUT}$  (%)

## 8.2 Long-Term Stability

One of the key parameters of the REF34xx references is long-term stability. Typical characteristic expressed as: curves shows the typical drift value for the REF34xx is 25 ppm from 0 to 1000 hours. This parameter is characterized by measuring 32 units at regular intervals for a period of 1000 hours. It is important to understand that long-term stability is not ensured by design and that the output from the device may shift beyond the typical 25 ppm specification at any time. For systems that require highly stable output voltages over long periods of time, the designer should consider burning in the devices prior to use to minimize the amount of output drift exhibited by the reference over time.

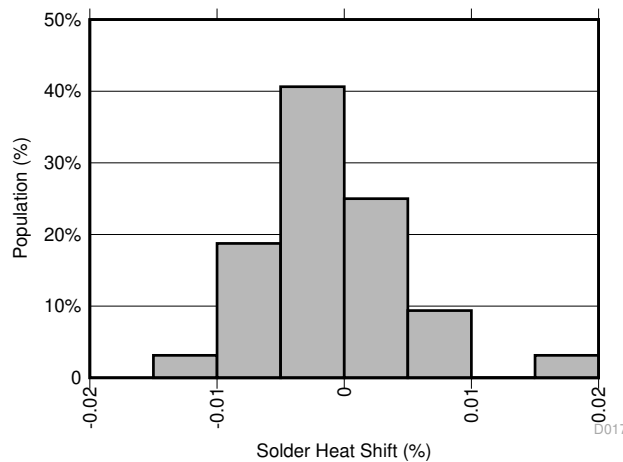

图 8-3. Long Term Stability - 1000 hours ( $V_{OUT}$ )

## 8.3 Thermal Hysteresis

Thermal hysteresis is measured with the REF34xx soldered to a PCB, similar to a real-world application. Thermal hysteresis for the device is defined as the change in output voltage after operating the device at 25°C, cycling the device through the specified temperature range, and returning to 25°C. The PCB was baked at 150°C for 30 minutes before thermal hysteresis was measured. Hysteresis can be expressed by 方程式 1:

$$V_{HYST} = \left( \frac{|V_{PRE} - V_{POST}|}{V_{NOM}} \right) \times 10^6 \text{ (ppm)} \quad (1)$$

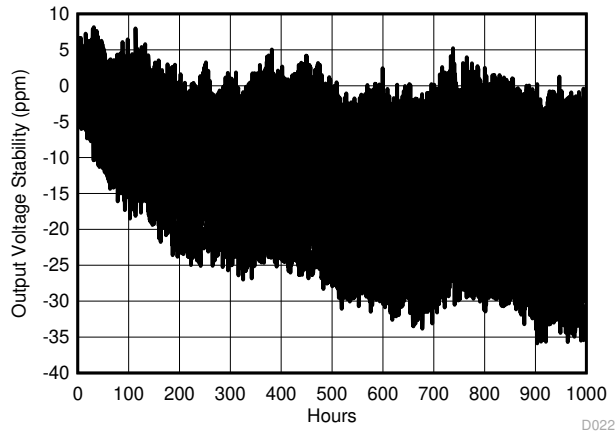
where

- $V_{HYST}$  = thermal hysteresis (in units of ppm)
- $V_{NOM}$  = the specified output voltage
- $V_{PRE}$  = output voltage measured at 25°C pre-temperature cycling
- $V_{POST}$  = output voltage measured after the device has cycled from 25°C through the specified temperature range of -40°C to +125°C and returns to 25°C.

Typical thermal hysteresis distribution is as shown in 图 8-4.



图 8-4. Thermal Hysteresis Distribution (V<sub>OUT</sub>)

## 8.4 Power Dissipation

The REF34xx voltage references are capable of source and sink up to 10 mA of load current across the rated input voltage range. However, when used in applications subject to high ambient temperatures, the input voltage and load current must be carefully monitored to ensure that the device does not exceed its maximum power dissipation rating. The maximum power dissipation of the device can be calculated with [方程式 2](#):

$$T_J = T_A + P_D \times R_{\theta JA} \quad (2)$$

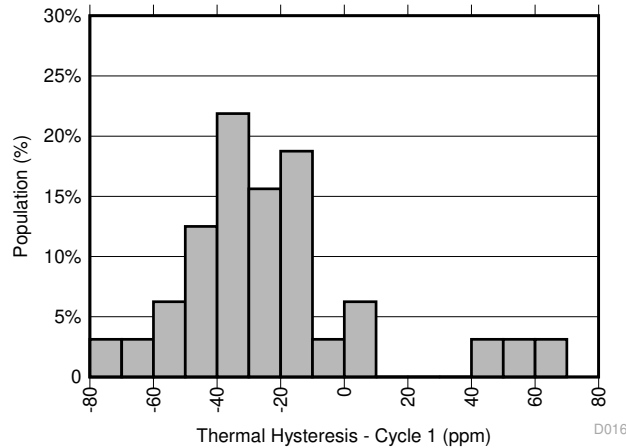
where

- $P_D$  is the device power dissipation
- $T_J$  is the device junction temperature
- $T_A$  is the ambient temperature
- $R_{\theta JA}$  is the package (junction-to-air) thermal resistance

Because of this relationship, acceptable load current in high temperature conditions may be less than the maximum current-sourcing capability of the device. In no case should the device be operated outside of its maximum power rating because doing so can result in premature failure or permanent damage to the device.

## 8.5 Noise Performance

Typical 0.1-Hz to 10-Hz voltage noise can be seen in [图 8-5](#). Device noise increases with output voltage and operating temperature. Additional filtering can be used to improve output noise levels, although care must be taken to ensure the output impedance does not degrade ac performance. Peak-to-peak noise measurement setup is shown in [图 8-5](#).

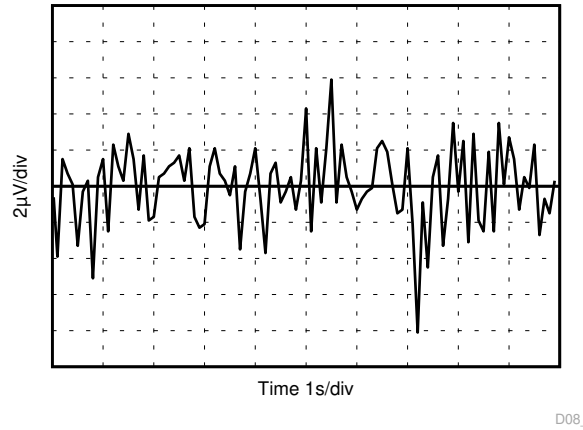

**图 8-5. 0.1-Hz to 10-Hz Noise ( $V_{OUT}$ )**

## 9 Detailed Description

### 9.1 Overview

The REF34xx is family of low-noise, precision bandgap voltage references that are specifically designed for excellent initial voltage accuracy and drift. The [Figure 9.2](#) is a simplified block diagram of the REF34xx showing basic band-gap topology.

### 9.2 Functional Block Diagram

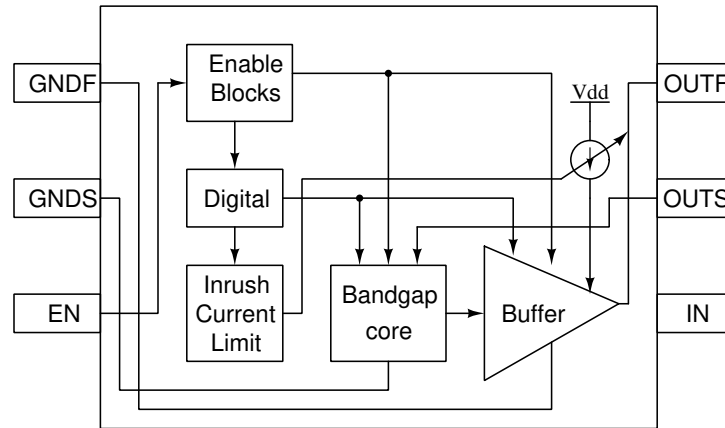

### 9.3 Feature Description

#### 9.3.1 Supply Voltage

The REF34xx family of references features an extremely low dropout voltage. For loaded conditions, a typical dropout voltage versus load is shown on the front page. The REF34xx features a low quiescent current that is extremely stable over changes in both temperature and supply. The typical room temperature quiescent current is 72  $\mu\text{A}$ , and the maximum quiescent current over temperature is just 95  $\mu\text{A}$ . Supply voltages below the specified levels can cause the REF34xx to momentarily draw currents greater than the typical quiescent current. Use a power supply with a fast rising edge and low output impedance to easily prevent this issue.

#### 9.3.2 Low Temperature Drift

The REF34xx is designed for minimal drift error, which is defined as the change in output voltage over temperature. The drift is calculated using the box method, as described by [Equation 3](#). For this equation,  $V_{\text{REF}}$  is  $V_{\text{OUT}}$  which is the output voltage seen at the junction of OUT\_F and OUT\_S.

$$\text{Drift} = \left( \frac{V_{\text{REF(MAX)}} - V_{\text{REF(MIN)}}}{V_{\text{REF}} \times \text{Temperature Range}} \right) \times 10^6 \quad (3)$$

#### 9.3.3 Load Current

The REF34xx family is specified to deliver a current load of  $\pm 10$  mA per output. The device temperature increases according to [Equation 4](#):

$$T_J = T_A + P_D \times R_{\theta JA} \quad (4)$$

where

- $T_J$  = junction temperature ( $^{\circ}\text{C}$ ),
- $T_A$  = ambient temperature ( $^{\circ}\text{C}$ ),
- $P_D$  = power dissipated (W), and
- $R_{\theta JA}$  = junction-to-ambient thermal resistance ( $^{\circ}\text{C}/\text{W}$ )

The REF34xx maximum junction temperature must not exceed the absolute maximum rating of  $150^{\circ}\text{C}$ .



## 9.4 Device Functional Modes

### 9.4.1 EN Pin

When the EN pin of the REF34xx is pulled high, the device is in active mode. The device must be in active mode for normal operation. The REF34xx can be placed in a low-power mode by pulling the enable pin, EN, low. When in shutdown mode, the output of the device becomes high impedance and the quiescent current of the device reduces to 2  $\mu\text{A}$  in shutdown mode. The EN pin must not be pulled higher than VIN supply voltage. See the [节 7.5](#) for logic high and logic low voltage levels.

### 9.4.2 Negative Reference Voltage

For applications requiring a negative and positive reference voltage, the REF34xx and OPA735 can be used to provide a dual-supply reference from a 5-V supply. [图 9-1](#) shows the REF34xx used to provide a 2.5-V supply reference voltage. The low drift performance of the REF34xx complements the low offset voltage and zero drift of the OPA735 to provide an accurate solution for split-supply applications. Take care to match the temperature coefficients of R1 and R2.

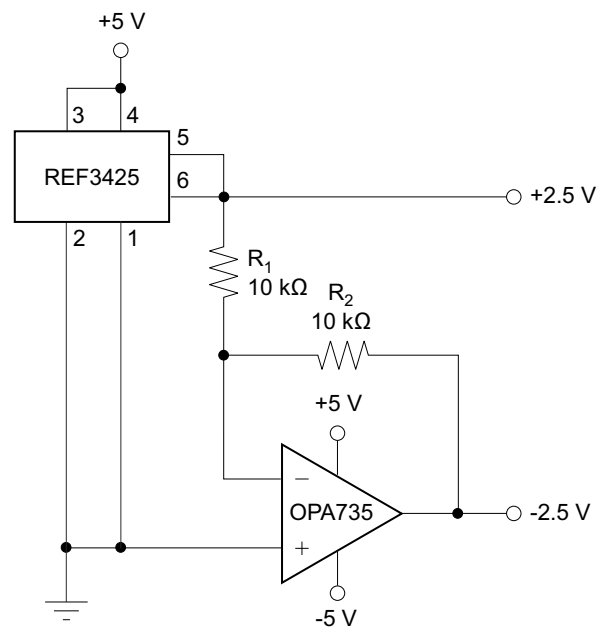

Copyright © 2017, Texas Instruments Incorporated

**图 9-1. REF34xx and OPA735 Create Positive and Negative Reference Voltages**

## 10 Application and Implementation

### Note

Information in the following applications sections is not part of the TI component specification, and TI does not warrant its accuracy or completeness. TI's customers are responsible for determining suitability of components for their purposes, as well as validating and testing their design implementation to confirm system functionality.

### 10.1 Application Information

As this device has many applications and setups, there are many situations that this datasheet can not characterize in detail. Basic applications includes positive/negative voltage reference and data acquisition systems. The table below shows the typical application of REF34xx and its companion ADC/DAC.

**表 10-1. Typical Applications and Companion ADC/DAC**

Applications	ADC/DAC
PLC - DCS	DAC8881, ADS8332, ADS8568, ADS8317, ADS8588S, ADS1287
Display Test Equipment	ADS8332
Field Transmitters - Pressure	ADUCM360
Video Surveillance - Thermal Cameras	ADS7279
Medical Blood Glucose Meter	ADS1112

### 10.2 Typical Application: Basic Voltage Reference Connection

The circuit shown in [图 10-1](#) shows the basic configuration for the REF34xx references. Connect bypass capacitors according to the guidelines in [节 10.2.2.1](#).

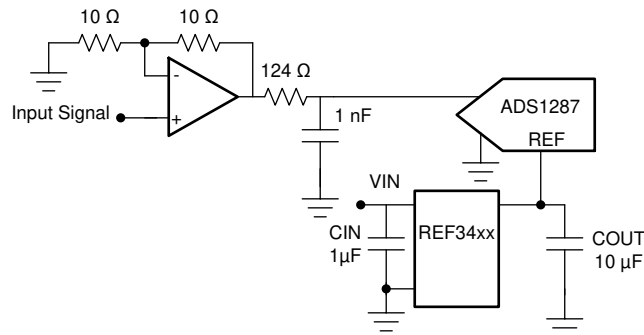

Copyright © 2017, Texas Instruments Incorporated

**图 10-1. Basic Reference Connection**

#### 10.2.1 Design Requirements

A detailed design procedure is described based on a design example. For this design example, use the parameters listed in [表 10-2](#) as the input parameters.

**表 10-2. Design Example Parameters**

DESIGN PARAMETER	VALUE
Input voltage $V_{IN}$	5 V
Output voltage $V_{OUT}$	2.5 V
REF34xx input capacitor	1 $\mu$ F
REF34xx output capacitor	10 $\mu$ F

## 10.2.2 Detailed Design Procedure

### 10.2.2.1 Input and Output Capacitors

A 1- $\mu$ F to 10- $\mu$ F electrolytic or ceramic capacitor can be connected to the input to improve transient response in applications where the supply voltage may fluctuate. Connect an additional 0.1- $\mu$ F ceramic capacitor in parallel to reduce high frequency supply noise.

A ceramic capacitor of at least a 0.1  $\mu$ F must be connected to the output to improve stability and help filter out high frequency noise. An additional 1- $\mu$ F to 10- $\mu$ F electrolytic or ceramic capacitor can be added in parallel to improve transient performance in response to sudden changes in load current; however, keep in mind that doing so increases the turnon time of the device.

Best performance and stability is attained with low-ESR, low-inductance ceramic chip-type output capacitors (X5R, X7R, or similar). If using an electrolytic capacitor on the output, place a 0.1- $\mu$ F ceramic capacitor in parallel to reduce overall ESR on the output.

### 10.2.2.2 4-Wire Kelvin Connections

Current flowing through a PCB trace produces an IR voltage drop, and with longer traces, this drop can reach several millivolts or more, introducing a considerable error into the output voltage of the reference. A 1-inch long, 5-millimeter wide trace of 1-ounce copper has a resistance of approximately 100 m $\Omega$  at room temperature; at a load current of 10 mA, this can introduce a full millivolt of error. In an ideal board layout, the reference must be mounted as close as possible to the load to minimize the length of the output traces, and, therefore, the error introduced by voltage drop. However, in applications where this is not possible or convenient, force and sense connections (sometimes referred to as Kelvin sensing connections) are provided as a means of minimizing the IR drop and improving accuracy.

Kelvin connections work by providing a set of high impedance voltage-sensing lines to the output and ground nodes. Because very little current flows through these connections, the IR drop across their traces is negligible, and the output and ground voltage information can be obtain with minimum IR drop error.

It is always advantageous to use Kelvin connections whenever possible. However, in applications where the IR drop is negligible or an extra set of traces cannot be routed to the load, the force and sense pins for both V<sub>OUT</sub> and GND can simply be tied together, and the device can be used in the same fashion as a normal 3-terminal reference (as shown in  9-1).

### 10.2.2.3 V<sub>IN</sub> Slew Rate Considerations

In applications with slow-rising input voltage signals, the reference exhibits overshoot or other transient anomalies that appear on the output. These phenomena also appear during shutdown as the internal circuitry loses power.

To avoid such conditions, ensure that the input voltage wave-form has both a rising and falling slew rate close to 6 V/ms.

### 10.2.2.4 Shutdown/Enable Feature

The REF34xx references can be switched to a low power shut-down mode when a voltage of 0.5 V or lower is input to the EN pin. Likewise, the reference becomes operational for EN voltages of 1.6 V or higher. During shutdown, the supply current drops to less than 2  $\mu$ A, useful in applications that are sensitive to power consumption.

If using the shutdown feature, ensure that the EN pin voltage does not fall between 0.5 V and 1.6 V because this causes a large increase in the supply current of the device and may keep the reference from starting up correctly. If not using the shutdown feature, however, the EN pin can simply be tied to the IN pin, and the reference remains operational continuously.

### 10.2.3 Application Curves

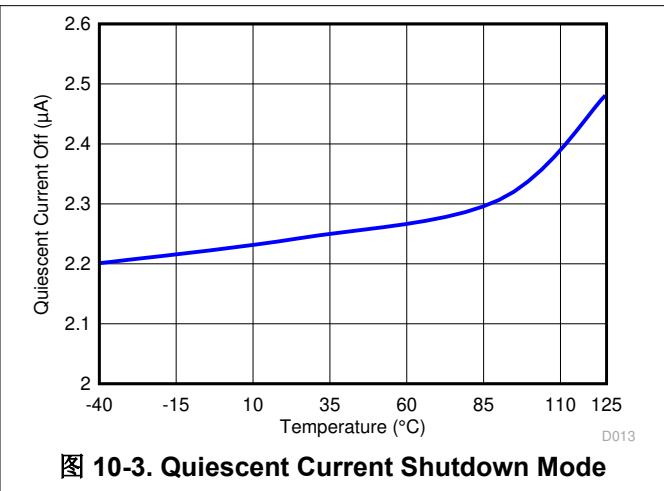
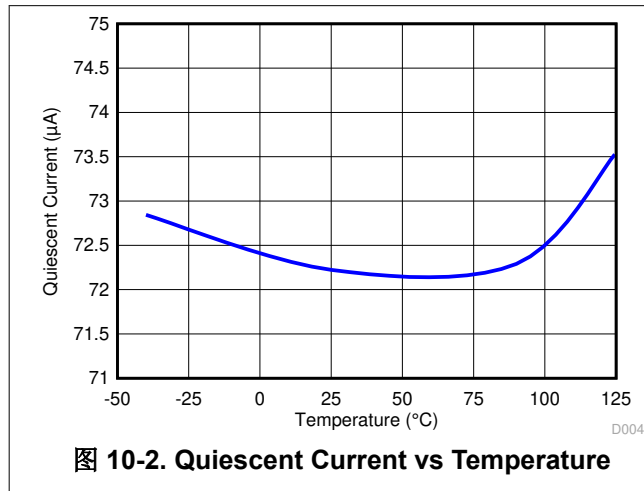

## 11 Power Supply Recommendations

The REF34xx family of references feature an extremely low-dropout voltage. These references can be operated with a supply of only 50 mV above the output voltage. TI recommends a supply bypass capacitor ranging between 0.1  $\mu$ F to 10  $\mu$ F.

## 12 Layout

### 12.1 Layout Guidelines

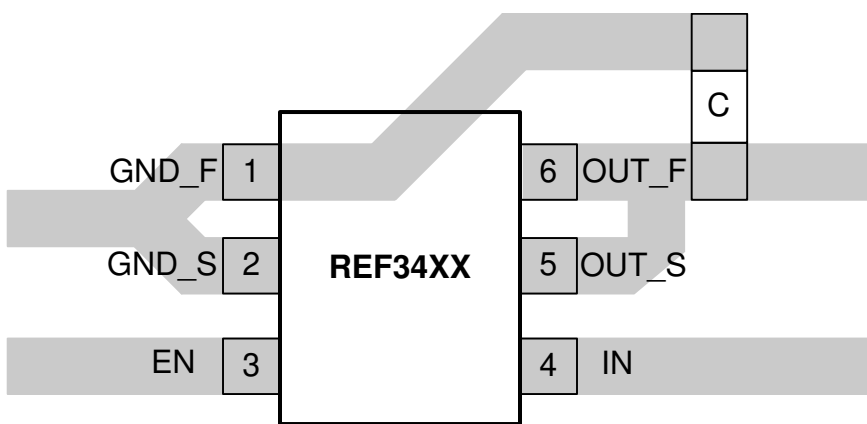
 Figure 12-1 illustrates an example of a PCB layout for a data acquisition system using the REF34xx. Some key considerations are:

- Connect low-ESR, 0.1- $\mu$ F ceramic bypass capacitors at IN, OUT\_F, VOUT of the REF34xx and REF34xxT.
- Decouple other active devices in the system per the device specifications.
- Using a solid ground plane helps distribute heat and reduces electromagnetic interference (EMI) noise pickup.
- Place the external components as close to the device as possible. This configuration prevents parasitic errors (such as the Seebeck effect) from occurring.
- Do not run sensitive analog traces in parallel with digital traces. Avoid crossing digital and analog traces if possible, and only make perpendicular crossings when absolutely necessary.

### 12.2 Layout Example



图 12-1. REF34xx Layout Example



图 12-2. REF34xxT Layout Example

## 13 Device and Documentation Support

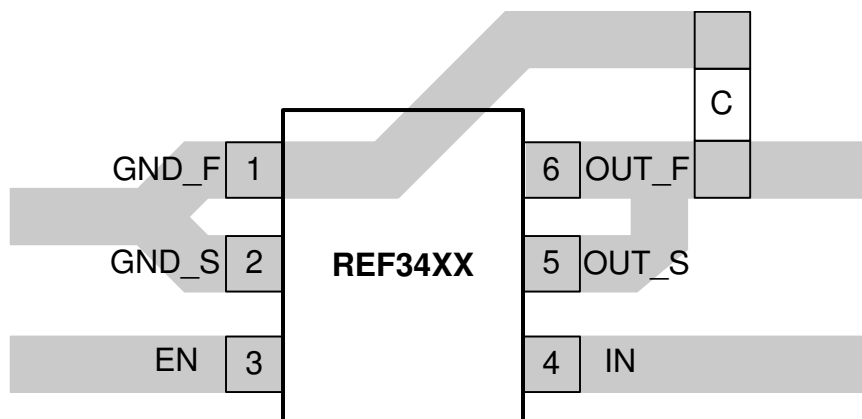
### 13.1 Documentation Support

#### 13.1.1 Related Documentation

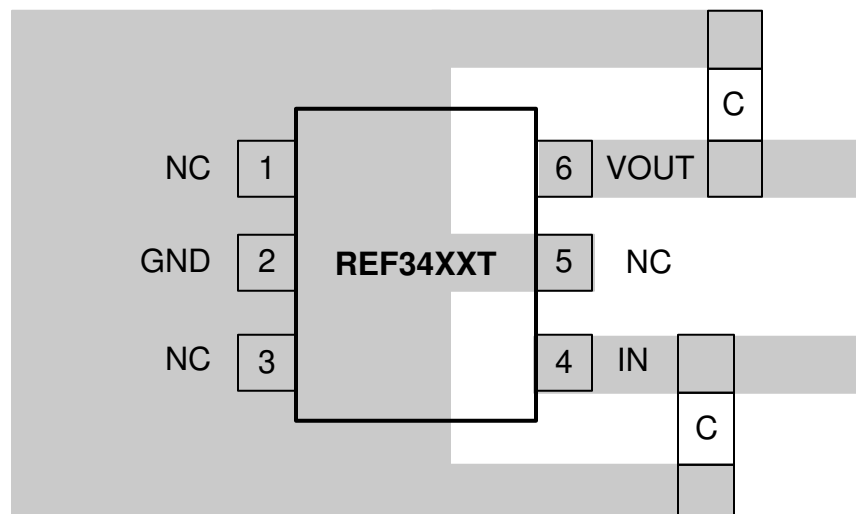
For related documentation see the following:

- [INA21x Voltage Output, Low- or High-Side Measurement, Bidirectional, Zero-Drift Series, Current-Shunt Monitors](#)
- [Low-Drift Bidirectional Single-Supply Low-Side Current Sensing Reference Design](#)

#### 13.2 接收文档更新通知

要接收文档更新通知，请导航至 [ti.com](http://ti.com) 上的器件产品文件夹。点击 [订阅更新](#) 进行注册，即可每周接收产品信息更改摘要。有关更改的详细信息，请查看任何已修订文档中包含的修订历史记录。

#### 13.3 支持资源

TI E2E™ [支持论坛](#) 是工程师的重要参考资料，可直接从专家获得快速、经过验证的解答和设计帮助。搜索现有解答或提出自己的问题可获得所需的快速设计帮助。

链接的内容由各个贡献者“按原样”提供。这些内容并不构成 TI 技术规范，并且不一定反映 TI 的观点；请参阅 TI 的 [《使用条款》](#)。

#### 13.4 Trademarks

TI E2E™ is a trademark of Texas Instruments.

所有商标均为其各自所有者的财产。

#### 13.5 静电放电警告



静电放电 (ESD) 会损坏这个集成电路。德州仪器 (TI) 建议通过适当的预防措施处理所有集成电路。如果不遵守正确的处理和安装程序，可能会损坏集成电路。

ESD 的损坏小至导致微小的性能降级，大至整个器件故障。精密的集成电路可能更容易受到损坏，这是因为非常细微的参数更改都可能会导致器件与其发布的规格不相符。

#### 13.6 术语表

[TI 术语表](#) 本术语表列出并解释了术语、首字母缩略词和定义。

## 14 Mechanical, Packaging, and Orderable Information

The following pages include mechanical packaging and orderable information. This information is the most current data available for the designated devices. This data is subject to change without notice and revision of this document. For browser-based versions of this data sheet, refer to the left-hand navigation.

**PACKAGING INFORMATION**

Orderable Device	Status (1)	Package Type	Package Drawing	Pins	Package Qty	Eco Plan (2)	Lead finish/ Ball material (6)	MSL Peak Temp (3)	Op Temp (°C)	Device Marking (4/5)	Samples
PREF3450TQDBVR	ACTIVE	SOT-23	DBV	6	3000	TBD	Call TI	Call TI	-40 to 125		<a href="#">Samples</a>
REF3425IDBVR	ACTIVE	SOT-23	DBV	6	3000	RoHS & Green	NIPDAU	Level-2-250C-1 YEAR	-40 to 125	19ED	<a href="#">Samples</a>
REF3425TIDBVR	ACTIVE	SOT-23	DBV	6	3000	RoHS & Green	NIPDAUAG	Level-2-260C-1 YEAR	-40 to 125	2EVC	<a href="#">Samples</a>
REF3430IDBVR	ACTIVE	SOT-23	DBV	6	3000	RoHS & Green	NIPDAU	Level-2-260C-1 YEAR	-40 to 125	1H6D	<a href="#">Samples</a>
REF3430TIDBVR	ACTIVE	SOT-23	DBV	6	3000	RoHS & Green	NIPDAUAG	Level-2-260C-1 YEAR	-40 to 125	2EUC	<a href="#">Samples</a>
REF3433IDBVR	ACTIVE	SOT-23	DBV	6	3000	RoHS & Green	NIPDAU	Level-2-260C-1 YEAR	-40 to 125	1H5D	<a href="#">Samples</a>
REF3433TIDBVR	ACTIVE	SOT-23	DBV	6	3000	RoHS & Green	NIPDAUAG	Level-2-260C-1 YEAR	-40 to 125	2ETC	<a href="#">Samples</a>
REF3440IDBVR	ACTIVE	SOT-23	DBV	6	3000	RoHS & Green	NIPDAU	Level-2-260C-1 YEAR	-40 to 125	1MJD	<a href="#">Samples</a>
REF3440TIDBVR	ACTIVE	SOT-23	DBV	6	3000	RoHS & Green	NIPDAUAG	Level-2-260C-1 YEAR	-40 to 125	2ESC	<a href="#">Samples</a>
REF3450IDBVR	ACTIVE	SOT-23	DBV	6	3000	RoHS & Green	NIPDAU	Level-2-260C-1 YEAR	-40 to 125	1MKD	<a href="#">Samples</a>
REF3450TIDBVR	ACTIVE	SOT-23	DBV	6	3000	RoHS & Green	NIPDAUAG	Level-2-260C-1 YEAR	-40 to 125	2ERC	<a href="#">Samples</a>

(1) The marketing status values are defined as follows:

**ACTIVE:** Product device recommended for new designs.

**LIFEBUY:** TI has announced that the device will be discontinued, and a lifetime-buy period is in effect.

**NRND:** Not recommended for new designs. Device is in production to support existing customers, but TI does not recommend using this part in a new design.

**PREVIEW:** Device has been announced but is not in production. Samples may or may not be available.

**OBSELETE:** TI has discontinued the production of the device.

(2) **RoHS:** TI defines "RoHS" to mean semiconductor products that are compliant with the current EU RoHS requirements for all 10 RoHS substances, including the requirement that RoHS substance do not exceed 0.1% by weight in homogeneous materials. Where designed to be soldered at high temperatures, "RoHS" products are suitable for use in specified lead-free processes. TI may reference these types of products as "Pb-Free".

**RoHS Exempt:** TI defines "RoHS Exempt" to mean products that contain lead but are compliant with EU RoHS pursuant to a specific EU RoHS exemption.

**Green:** TI defines "Green" to mean the content of Chlorine (Cl) and Bromine (Br) based flame retardants meet JS709B low halogen requirements of <=1000ppm threshold. Antimony trioxide based flame retardants must also meet the <=1000ppm threshold requirement.

(3) MSL, Peak Temp. - The Moisture Sensitivity Level rating according to the JEDEC industry standard classifications, and peak solder temperature.

- (4) There may be additional marking, which relates to the logo, the lot trace code information, or the environmental category on the device.
- (5) Multiple Device Markings will be inside parentheses. Only one Device Marking contained in parentheses and separated by a "~" will appear on a device. If a line is indented then it is a continuation of the previous line and the two combined represent the entire Device Marking for that device.
- (6) Lead finish/Ball material - Orderable Devices may have multiple material finish options. Finish options are separated by a vertical ruled line. Lead finish/Ball material values may wrap to two lines if the finish value exceeds the maximum column width.

**Important Information and Disclaimer:**The information provided on this page represents TI's knowledge and belief as of the date that it is provided. TI bases its knowledge and belief on information provided by third parties, and makes no representation or warranty as to the accuracy of such information. Efforts are underway to better integrate information from third parties. TI has taken and continues to take reasonable steps to provide representative and accurate information but may not have conducted destructive testing or chemical analysis on incoming materials and chemicals. TI and TI suppliers consider certain information to be proprietary, and thus CAS numbers and other limited information may not be available for release.

In no event shall TI's liability arising out of such information exceed the total purchase price of the TI part(s) at issue in this document sold by TI to Customer on an annual basis.

**OTHER QUALIFIED VERSIONS OF REF3425, REF3430, REF3433, REF3440 :**

- Enhanced Product : [REF3425-EP](#), [REF3430-EP](#), [REF3433-EP](#), [REF3440-EP](#)

NOTE: Qualified Version Definitions:

- Enhanced Product - Supports Defense, Aerospace and Medical Applications



## TAPE AND REEL INFORMATION



### QUADRANT ASSIGNMENTS FOR PIN 1 ORIENTATION IN TAPE



\*All dimensions are nominal

Device	Package Type	Package Drawing	Pins	SPQ	Reel Diameter (mm)	Reel Width W1 (mm)	A0 (mm)	B0 (mm)	K0 (mm)	P1 (mm)	W (mm)	Pin1 Quadrant
REF3425IDBVR	SOT-23	DBV	6	3000	178.0	9.0	3.23	3.17	1.37	4.0	8.0	Q3
REF3425TIDBVR	SOT-23	DBV	6	3000	180.0	8.4	3.23	3.17	1.37	4.0	8.0	Q3
REF3430IDBVR	SOT-23	DBV	6	3000	178.0	9.0	3.23	3.17	1.37	4.0	8.0	Q3
REF3430TIDBVR	SOT-23	DBV	6	3000	180.0	8.4	3.23	3.17	1.37	4.0	8.0	Q3
REF3433IDBVR	SOT-23	DBV	6	3000	178.0	9.0	3.23	3.17	1.37	4.0	8.0	Q3
REF3433TIDBVR	SOT-23	DBV	6	3000	180.0	8.4	3.23	3.17	1.37	4.0	8.0	Q3
REF3440IDBVR	SOT-23	DBV	6	3000	178.0	9.0	3.23	3.17	1.37	4.0	8.0	Q3
REF3440TIDBVR	SOT-23	DBV	6	3000	180.0	8.4	3.23	3.17	1.37	4.0	8.0	Q3
REF3450IDBVR	SOT-23	DBV	6	3000	178.0	9.0	3.23	3.17	1.37	4.0	8.0	Q3
REF3450TIDBVR	SOT-23	DBV	6	3000	180.0	8.4	3.23	3.17	1.37	4.0	8.0	Q3

**TAPE AND REEL BOX DIMENSIONS**

\*All dimensions are nominal

Device	Package Type	Package Drawing	Pins	SPQ	Length (mm)	Width (mm)	Height (mm)
REF3425IDBVR	SOT-23	DBV	6	3000	445.0	220.0	345.0
REF3425TIDBVR	SOT-23	DBV	6	3000	213.0	191.0	35.0
REF3430IDBVR	SOT-23	DBV	6	3000	445.0	220.0	345.0
REF3430TIDBVR	SOT-23	DBV	6	3000	213.0	191.0	35.0
REF3433IDBVR	SOT-23	DBV	6	3000	445.0	220.0	345.0
REF3433TIDBVR	SOT-23	DBV	6	3000	213.0	191.0	35.0
REF3440IDBVR	SOT-23	DBV	6	3000	445.0	220.0	345.0
REF3440TIDBVR	SOT-23	DBV	6	3000	213.0	191.0	35.0
REF3450IDBVR	SOT-23	DBV	6	3000	445.0	220.0	345.0
REF3450TIDBVR	SOT-23	DBV	6	3000	213.0	191.0	35.0

DBV0006A



# PACKAGE OUTLINE

SOT-23 - 1.45 mm max height

SMALL OUTLINE TRANSISTOR

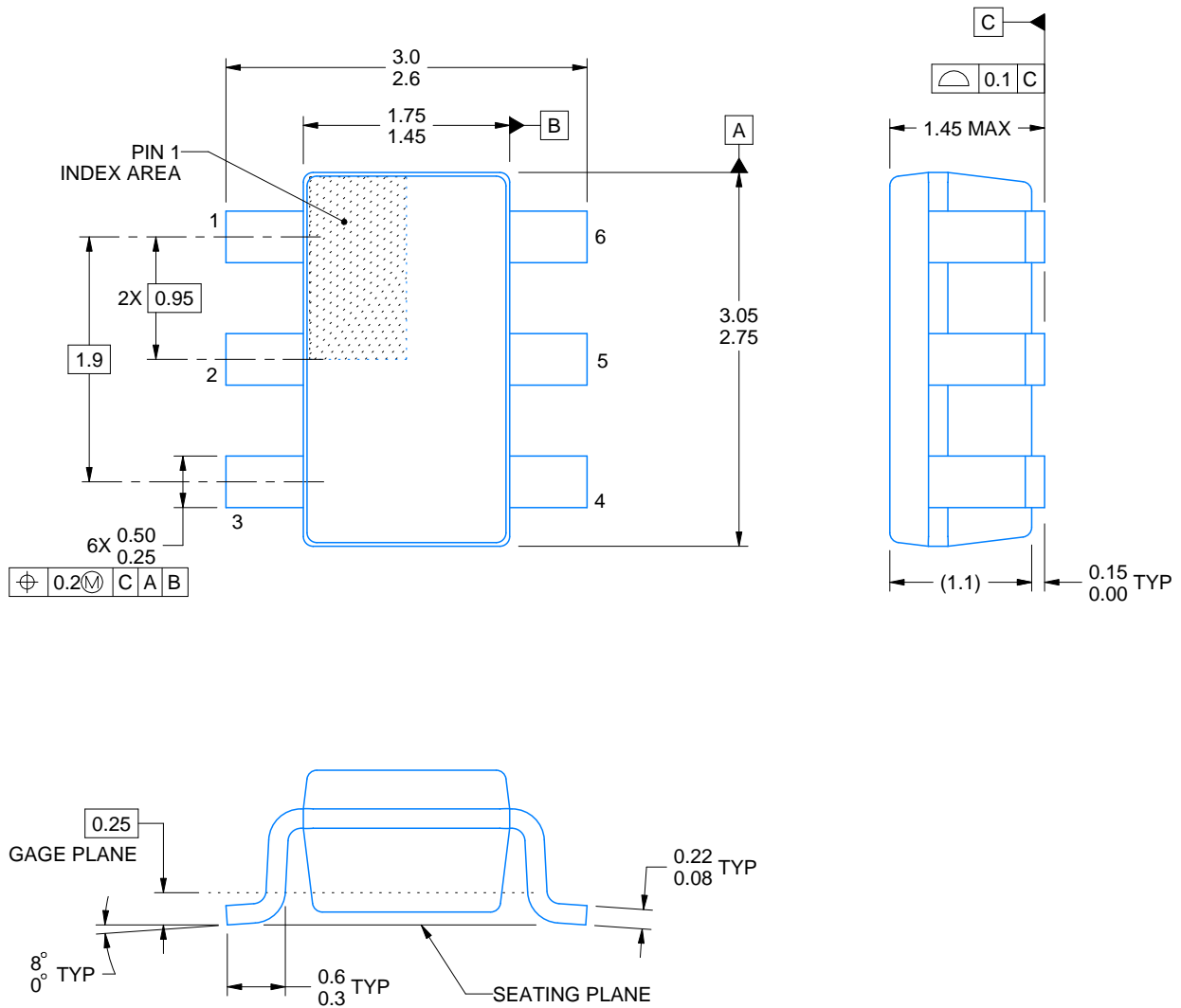

4214840/C 06/2021

## NOTES:

1. All linear dimensions are in millimeters. Any dimensions in parenthesis are for reference only. Dimensioning and tolerancing per ASME Y14.5M.
2. This drawing is subject to change without notice.
3. Body dimensions do not include mold flash or protrusion. Mold flash and protrusion shall not exceed 0.25 per side.
4. Leads 1,2,3 may be wider than leads 4,5,6 for package orientation.
5. Reference JEDEC MO-178.

# EXAMPLE BOARD LAYOUT

DBV0006A

SOT-23 - 1.45 mm max height

SMALL OUTLINE TRANSISTOR



LAND PATTERN EXAMPLE  
EXPOSED METAL SHOWN  
SCALE:15X



SOLDER MASK DETAILS

4214840/C 06/2021

NOTES: (continued)

6. Publication IPC-7351 may have alternate designs.

7. Solder mask tolerances between and around signal pads can vary based on board fabrication site.

# EXAMPLE STENCIL DESIGN

DBV0006A

SOT-23 - 1.45 mm max height

SMALL OUTLINE TRANSISTOR



SOLDER PASTE EXAMPLE  
BASED ON 0.125 mm THICK STENCIL  
SCALE:15X

4214840/C 06/2021

NOTES: (continued)

8. Laser cutting apertures with trapezoidal walls and rounded corners may offer better paste release. IPC-7525 may have alternate design recommendations.
9. Board assembly site may have different recommendations for stencil design.

## 重要声明和免责声明

TI“按原样”提供技术和可靠性数据（包括数据表）、设计资源（包括参考设计）、应用或其他设计建议、网络工具、安全信息和其他资源，不保证没有瑕疵且不做任何明示或暗示的担保，包括但不限于对适销性、某特定用途方面的适用性或不侵犯任何第三方知识产权的暗示担保。

这些资源可供使用 TI 产品进行设计的熟练开发人员使用。您将自行承担以下全部责任：(1) 针对您的应用选择合适的 TI 产品，(2) 设计、验证并测试您的应用，(3) 确保您的应用满足相应标准以及任何其他功能安全、信息安全、监管或其他要求。

这些资源如有变更，恕不另行通知。TI 授权您仅可将这些资源用于研发本资源所述的 TI 产品的应用。严禁对这些资源进行其他复制或展示。您无权使用任何其他 TI 知识产权或任何第三方知识产权。您应全额赔偿因在这些资源的使用中对 TI 及其代表造成的任何索赔、损害、成本、损失和债务，TI 对此概不负责。

TI 提供的产品受 [TI 的销售条款](#) 或 [ti.com](#) 上其他适用条款/TI 产品随附的其他适用条款的约束。TI 提供这些资源并不会扩展或以其他方式更改 TI 针对 TI 产品发布的适用的担保或担保免责声明。

TI 反对并拒绝您可能提出的任何其他或不同的条款。

邮寄地址：Texas Instruments, Post Office Box 655303, Dallas, Texas 75265

Copyright © 2021，德州仪器 (TI) 公司