

EC21A EC21C

21 mm Size Ring Type

Ring encoder with 4mm height contribute to space saving and multifunctioning

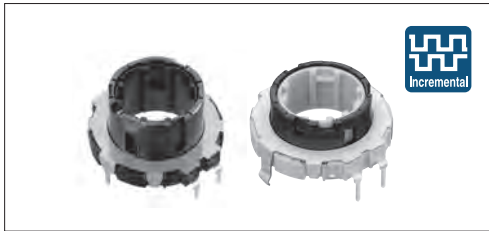

Typical Specifications

Items	Specifications
Rating	10mA 5V DC
Operating life	50,000 cycles
Operating temperature range	-40°C to +85°C

Product Line

Mounting method	Actuator length (mm)	Detent torque (mN·m)	Number of detent	Number of pulse	Minimum order unit (pcs.)		Product No.	No.
					Japan	Export		
Dip	9	7±5	30	15	600	1,200	EC21A1540401	1
		16±7					EC21A1520401	
	15	16±7	18	9	240	480	EC21A0920401	2
		12±5	30	15	600	1,200	EC21A1520407	3
Reflow	12	17±8 (Initial), 12± $\frac{7}{4}$ (After reflow)	30	15	640	640	EC21A0950402	4
							EC21C1520402	5

Packing Specifications

Tray

Product No.	Number of packages (pcs.)		Export package measurements (mm)
	1 case /Japan	1 case /export packing	
EC21A0920401	240	480	375×285×223
EC21A1520401 EC21A1540401	600	1,200	508×364×192
EC21A1520407 EC21A0950402	600	1,200	540×360×290
EC21C	640	640	400×310×185

Dimensions

Unit:mm





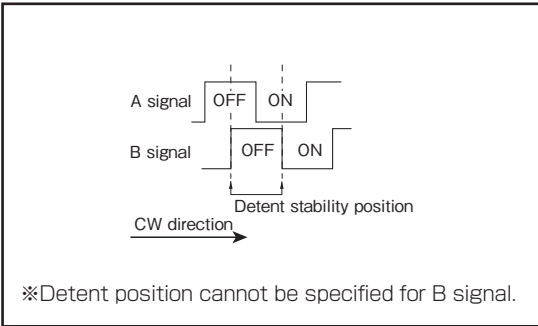

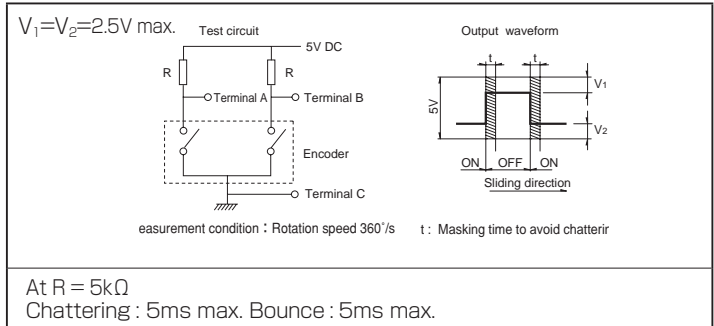

No.	Photo	Style	PC board mounting hole dimensions (Viewed from mounting side)
1	<p>EC21A Actuator length 9mm 15 pulse/30 detent</p>		<p>Shaded area: Wiring prohibited area</p>

■ Output Wave



■ Sliding Noise



Type		Through shaft type			Ring type	
		5mm size		10mm size	21mm size	
Series		EC05E		EC10E	EC21A	EC21C
Photo						
Output		Incremental (Two phase A and B)				
Shaft types		Through shaft type			Ring type	
Control part orientation		Vertical	Horizontal	Horizontal	—	—
Number of pulse / Number of detent		12/12		12/24 12/12	9/18 15/30	15/30
Features		Surface mount type		—	—	—
Dimensions (mm)	W	5.7	7.5	9.8	21.6	22
	D	6	3.3	4.4		21.6
	H	2.7	7.25	10.6/12.6/14.6	4	
Operating temperature range		-30°C to +85°C		-5°C to +45°C -40°C to +85°C (For Automotive)	-40°C to +85°C	
Operating life		100,000 cycles			50,000 cycles	
Automotive use		—		○	●	●
Life cycle (availability)						
Electrical performance	Rating	0.55mA 5.5V DC		1mA 5V DC	10mA 5V DC	
	Max./min. operating current (Resistive load)	0.55mA / —		—	10mA / 1mA	
	Insulation resistance	50MΩ min. 50V DC			100MΩ min. 250V DC	
	Voltage proof	50V AC for 1 minute			300V AC for 1minute or 360V AC for 2s	300V AC for 1minute or 360V AC for 1s
Mechanical performance	Rotational torque (Without detent)	—		—	—	—
	Detent torque	1.6±1.3mN·m		5±3mN·m 6±3mN·m	7±5mN·m 12±5mN·m 16±7mN·m	17±8mN·m (Initial) 12±7mN·m (After reflow)
	Push-pull strength	—		—	100N	
Shaft configuration		Through shaft type			Ring type	
Terminal type		Reflow		Insertion		
Switch Specifications	Switch type	—		—	—	—
	Contact arrangement	—		—	—	—
	Travel (mm)	—		—	—	—
	Operating force (N)	—		—	—	—
	Rating	—		—	—	—
	Contact resistance	—		—	—	—
	Operating life	—		—	—	—
Page		260		262	263	

Encoders Soldering Conditions	275
Encoders Cautions	276

Notes

- The operating temperature range for automotive applications can be raised upon request. Please contact us for details.
- Indicates applicability to all products in the series, while ○ indicates applicability to some products in the series.

Reference for Manual Soldering

Series	Tip temperature	Soldering time	No. of solders
EC05E, EC09E, EC10E, EC111, EC11E, EC11M, EC11N, EC12D, EC12E, EC18A, EC21A, EC28A, EC35A, EC35AH, EC40A, EC50A, EM11B, EC21C, EC28C, EC35CH	350°C max.	3s max.	1 time

Reference for Dip Soldering

Series	Preheating		Dip soldering		No. of solders
	Soldering surface temperature	Heating time	Soldering temperature	Soldering time	
EC09E, EC111, EC11E, EC11M, EC11N, EC18A, EC21A, EC28A, EC35A, EC35AH, EC50A	100°C max.	2 min. max.	260±5°C	5±1s	2 times max.
EM11B	100°C max.	1 min. max.	260°C max.	3s max.	2 times max.
EC10E, EC12D, EC12E	100°C max.	1 min. max.	260±5°C	3±1s	2 times max.
EC40A	110°C max.	1 min. max.	260°C max.	10s max.	1 time

Example of Reflow Soldering Condition

Temperature profile

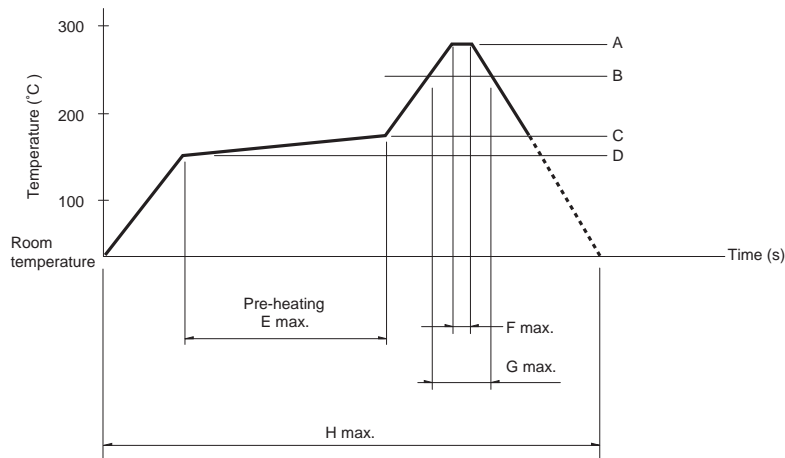

Series	A	B	C	D	E	F	G	H	No. of reflows
EC05E	250°C min.	230°C min.	180°C	150°C	60s to 120s	—	30s to 40s	—	2 times max.
EC21C	230°C to 245°C	220°C	200°C	150°C	60s to 120s	—	25s to 60s	300s max.	1 time max.
EC28C, EC35CH	260°C	230°C	180°C	150°C	2 min. min.	3s	40s	230s max.	1 time max.

Notes

1. When using an infrared reflow oven, solder may sometimes not be applied. Be sure to use a hot air reflow oven or a type that uses infrared rays in combination with hot air.
2. The temperatures given above are the maximum temperatures at the terminals of the encoder when employing a hot air reflow method. The temperature of the PC board and the surface temperature of the encoder may vary greatly depending on the PC board material, its size and thickness. Ensure that the surface temperature of the encoder does not rise to 250°C or greater.
3. Conditions vary to some extent depending on the type of reflow bath used. Be sure to give due consideration to this prior to use.