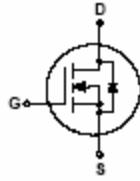
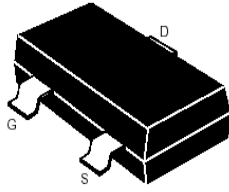

**SOT-23**

**Features**

- Low  $R_{DS(on)}$  @  $V_{GS}=10V$
- 5V Logic Level Control
- N Channel SOT23 Package
- HMB ESD Protection
- Pb-Free, RoHS Compliant

**Applications**

- Relay Driver
- ON/OFF Switch
- High-speed line Driver
- Power Management in Portable and Battery etc.

$V_{(BR)DSS}$	$R_{DS(ON)}$ Typ	$I_D$ Max
100V	3.5Ω @ 10V	0.2A
	4Ω @ 4.5V	

**Order Information**

Product	Package	Marking	Packing	Min Unit Quantity
BSS123	SOT23	SAW89	3000PCS/Reel	3000PCS

**Absolute Maximum Ratings**

Stresses exceeding Maximum Ratings may damage the device. Maximum Ratings are stress ratings only. Functional operation above the Recommended Operating Conditions is not implied. Extended exposure to stresses above the Recommended Operating Conditions may affect device reliability.

Symbol	Parameter	Rating	Unit	
<b>Common Ratings (<math>T_A=25^\circ\text{C}</math> Unless Otherwise Noted)</b>				
$V_{GS}$	Gate-Source Voltage	±20	V	
$V_{(BR)DSS}$	Drain-Source Breakdown Voltage	100	V	
$T_J$	Maximum Junction Temperature	150	°C	
$T_{STG}$	Storage Temperature Range	-50 to 150	°C	
<b>Mounted on Large Heat Sink</b>				
$I_{DM}$	Pulse Drain Current Tested①	$T_A=25^\circ\text{C}$	0.8	A
$I_D$	Continuous Drain Current	$T_A=25^\circ\text{C}$	0.2	A
		$T_A=70^\circ\text{C}$	0.15	
$P_D$	Maximum Power Dissipation	$T_A=25^\circ\text{C}$	0.3	W
		$T_A=70^\circ\text{C}$	0.2	
$R_{\theta JA}$	Thermal Resistance Junction-Ambient	400	°C/W	

Symbol	Parameter	Condition	Min	Typ	Max	Unit
<b>Static Electrical Characteristics @ T<sub>J</sub> = 25°C (unless otherwise stated)</b>						
V <sub>(BR)DSS</sub>	Drain-Source Breakdown Voltage	V <sub>GS</sub> =0V I <sub>D</sub> =250μA	100	--	--	V
I <sub>DSS</sub>	Zero Gate Voltage Drain Current(T <sub>A</sub> =25°C)	V <sub>DS</sub> =100V, V <sub>GS</sub> =0V	--	--	1	μA
	Zero Gate Voltage Drain Current(T <sub>A</sub> =125°C)	V <sub>DS</sub> =80V, V <sub>GS</sub> =0V	--	--	100	uA
I <sub>GSS</sub>	Gate-Body Leakage Current	V <sub>GS</sub> =±20V, V <sub>DS</sub> =0V	--	--	±10	uA
V <sub>GS(TH)</sub>	Gate Threshold Voltage	V <sub>DS</sub> =V <sub>GS</sub> , I <sub>D</sub> =250μA	1.0	2.0	3.0	V
R <sub>DS(ON)</sub>	Drain-Source On-State Resistance <sup>②</sup>	V <sub>GS</sub> =10V, I <sub>D</sub> =0.2A	--	3.5	6	Ω
R <sub>DS(ON)</sub>	Drain-Source On-State Resistance <sup>②</sup>	V <sub>GS</sub> =4.5V, I <sub>D</sub> =0.1A	--	4	8	Ω
<b>Dynamic Electrical Characteristics @ T<sub>J</sub> = 25°C (unless otherwise stated)</b>						
C <sub>iss</sub>	Input Capacitance	V <sub>DS</sub> =50V, V <sub>GS</sub> =0V, f=1MHz	--	31.6	--	pF
C <sub>oss</sub>	Output Capacitance		--	2.8	--	pF
C <sub>rss</sub>	Reverse Transfer Capacitance		--	2	--	pF
Q <sub>g</sub>	Total Gate Charge	V <sub>DS</sub> =50V I <sub>D</sub> =0.2A, V <sub>GS</sub> =10V	--	0.74	--	nC
Q <sub>gs</sub>	Gate Source Charge		--	0.08	--	nC
Q <sub>gd</sub>	Gate Drain Charge		--	0.26	--	nC
<b>Switching Characteristics @ T<sub>J</sub> = 25°C (unless otherwise stated)</b>						
t <sub>d(on)</sub>	Turn on Delay Time	V <sub>DD</sub> =50V, I <sub>D</sub> =0.2A, R <sub>G</sub> =3.3Ω, V <sub>GS</sub> =10V	--	2	--	ns
t <sub>r</sub>	Turn on Rise Time		--	3.1	--	ns
t <sub>d(off)</sub>	Turn Off Delay Time		-	6.5	--	ns
t <sub>f</sub>	Turn Off Fall Time		--	15	--	ns
<b>Source Drain Diode Characteristics @ T<sub>J</sub> = 25°C (unless otherwise stated)</b>						
I <sub>SD</sub>	Source drain current(Body Diode)	T <sub>A</sub> =25°C	--	--	0.1	A
V <sub>SD</sub>	Forward on voltage <sup>②</sup>	T <sub>J</sub> =25°C, I <sub>SD</sub> =0.2A, V <sub>GS</sub> =0V	--	0.85	1.2	V

Notes:

① Pulse width limited by maximum allowable junction temperature

② Pulse test ; Pulse width≤300μs, duty cycle≤2%.



Typical Characteristics

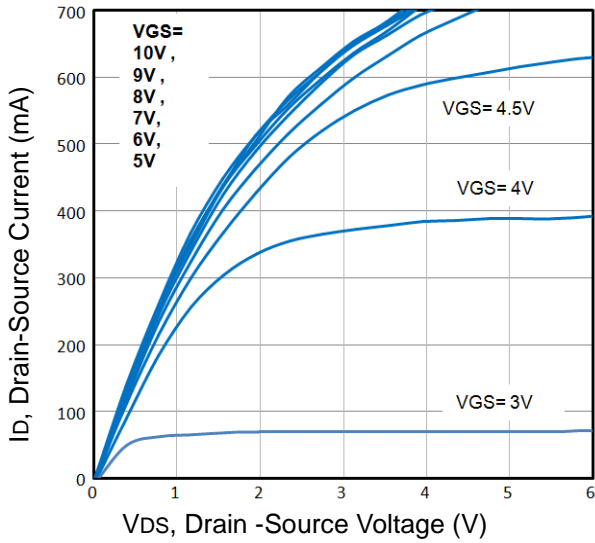

Fig1. Typical Output Characteristics

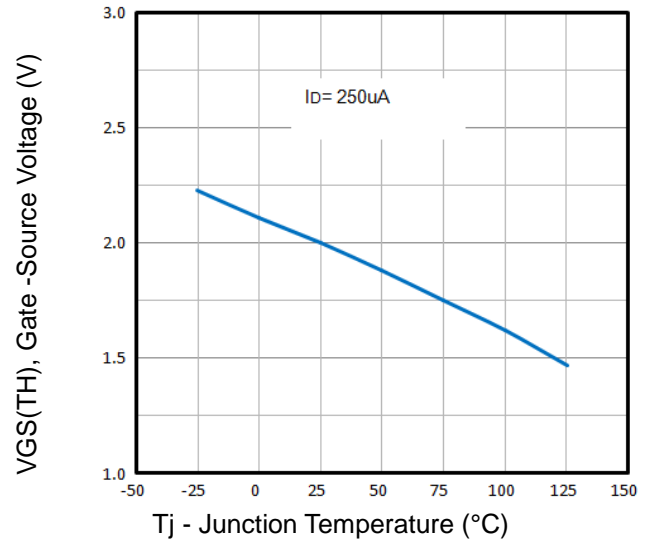

Fig2. Normalized Threshold Voltage Vs. Temperature

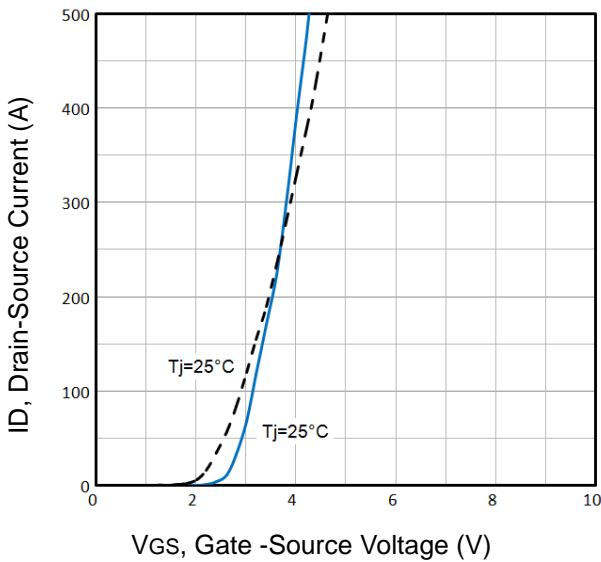

Fig3. Typical Transfer Characteristics

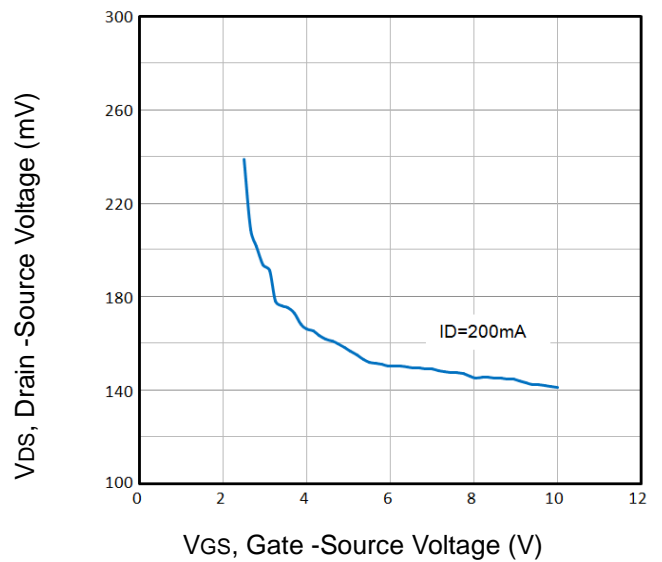

Fig4. Drain-Source Voltage vs Gate-Source Voltage

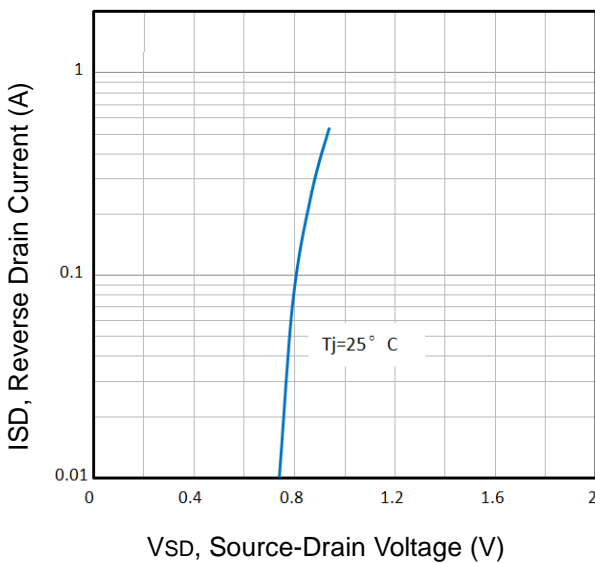

Fig5. Typical Source-Drain Diode Forward Voltage

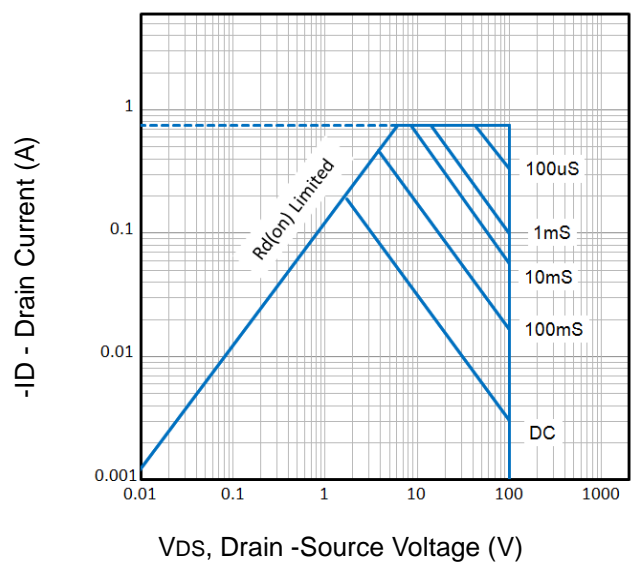

Fig6. Maximum Safe Operating Area

Typical Characteristics

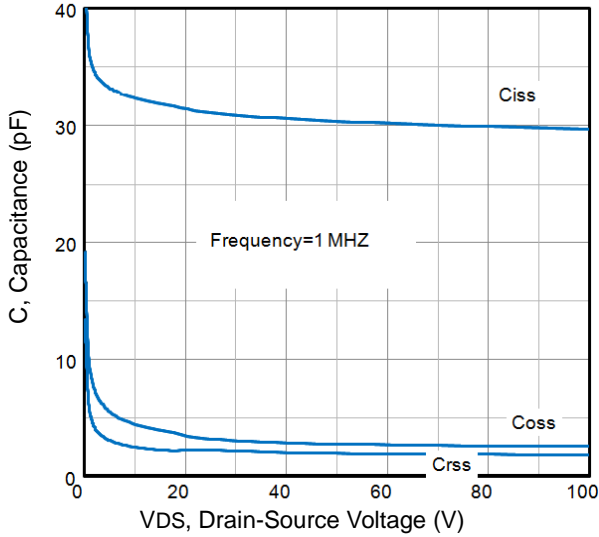

Fig7. Typical Capacitance Vs. Drain-Source Voltage

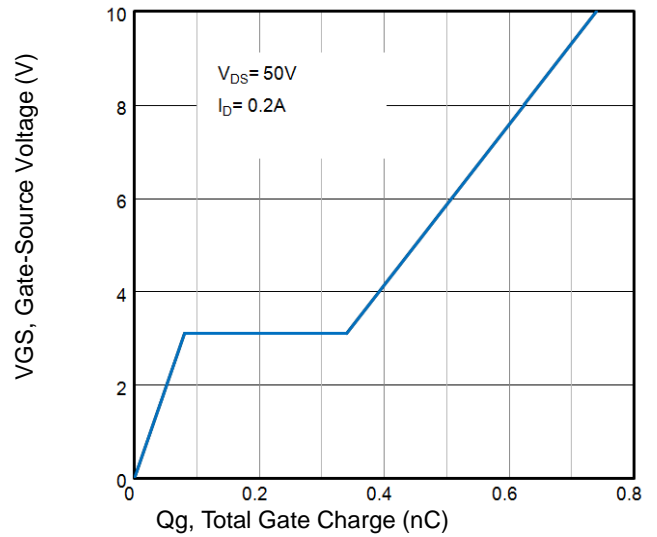

Fig8. Typical Gate Charge Vs. Gate-Source Voltage

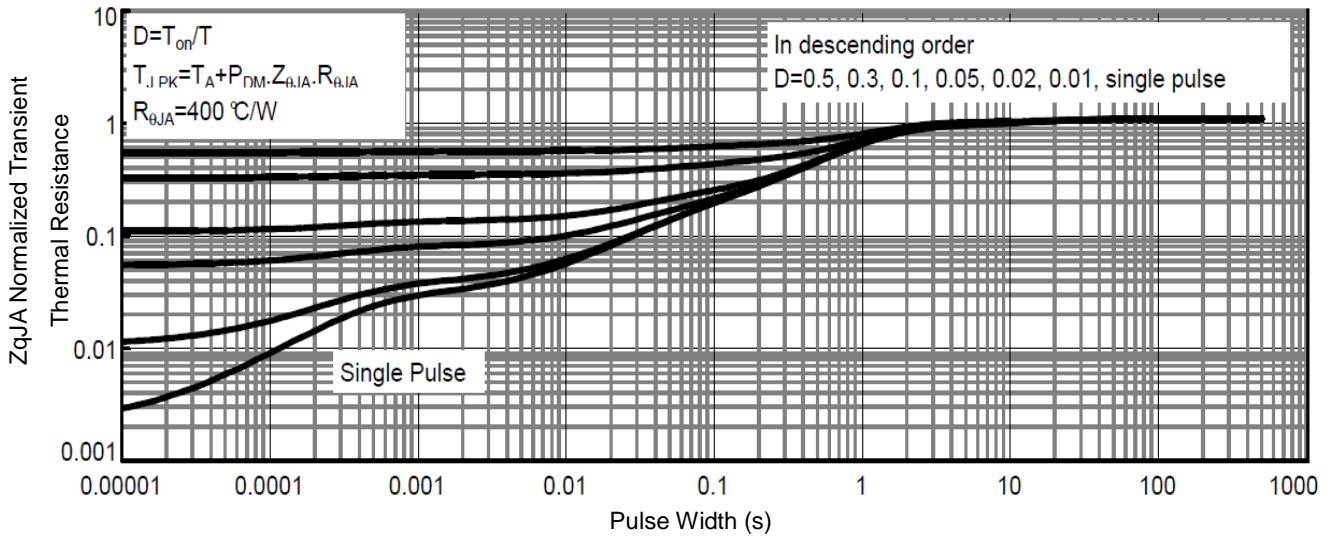
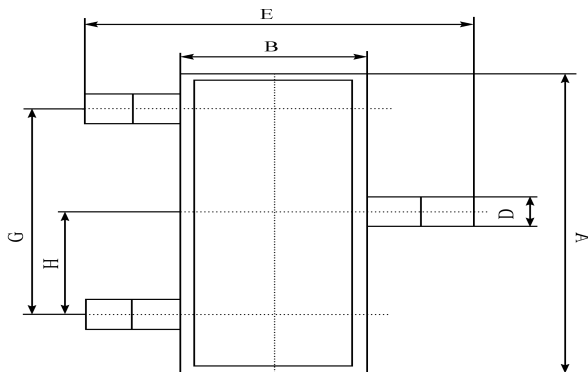

Fig9. Normalized Maximum Transient Thermal Impedance

SOT-23 PACKAGE OUTLINE Plastic surface mounted package



SOT-23	
A	2.90 ± 0.10
B	1.30 ± 0.10
C	1.00 ± 0.10
D	0.40 ± 0.10
E	2.40 ± 0.20
G	1.90 ± 0.10
H	0.95 ± 0.05
J	0.13 ± 0.05
K	0.00-0.10
M	≥ 0.2
N	0.60 ± 0.10
P	7 ± 2°

(UNIT): mm

