

MMBD4148 / SE / CC / CA Silicon Epitaxial Planar Switching Diode

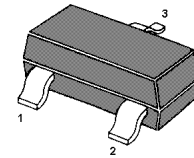
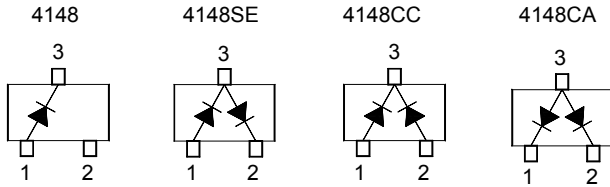

MMBD4148 Marking Code: **5H**
 MMBD4148SE Marking Code: **D4**
 MMBD4148CC Marking Code: **D5**
 MMBD4148CA Marking Code: **D6**
 SOT-23 Plastic Package

Absolute Maximum Ratings ($T_a = 25\text{ }^\circ\text{C}$)

Parameter	Symbol	Value	Unit
Maximum Repetitive Reverse Voltage	V_{RRM}	100	V
Reverse Voltage	V_R	75	V
Average Rectified Forward Current	$I_{F(AV)}$	200	mA
DC Forward Current	I_{FM}	600	mA
Recurrent Peak Forward Current	I_{FRM}	700	mA
Non-repetitive Peak Forward Surge Current	I_{FSM}	1 2	A
		at $t = 1\text{ s}$ at $t = 1\text{ }\mu\text{s}$	
Total Device Dissipation	P_{tot}	350	mW
Operating Junction Temperature	T_j	150	$^\circ\text{C}$
Storage Temperature Range	T_{stg}	- 55 to + 150	$^\circ\text{C}$

Characteristics at $T_a = 25\text{ }^\circ\text{C}$

Parameter	Symbol	Min.	Max.	Unit
Forward Voltage at $I_F = 10\text{ mA}$	V_F	-	1	V
Reverse Breakdown Voltage at $I_R = 100\text{ }\mu\text{A}$ at $I_R = 5\text{ }\mu\text{A}$	$V_{(BR)R}$	100 75	- -	V
Reverse Current at $V_R = 20\text{ V}$ at $V_R = 75\text{ V}$ at $V_R = 20\text{ V}$, $T_a = 150\text{ }^\circ\text{C}$	I_R	- - -	25 5 50	nA μA μA
Reverse Recovery Time at $I_F = 10\text{ mA}$, $V_R = 6\text{ V}$, $I_{RR} = 1\text{ mA}$, $R_L = 100\text{ }\Omega$	t_{rr}	-	4	ns
Total Capacitance at $V_R = 0\text{ V}$, $f = 1\text{ MHz}$	C_T	-	4	pF

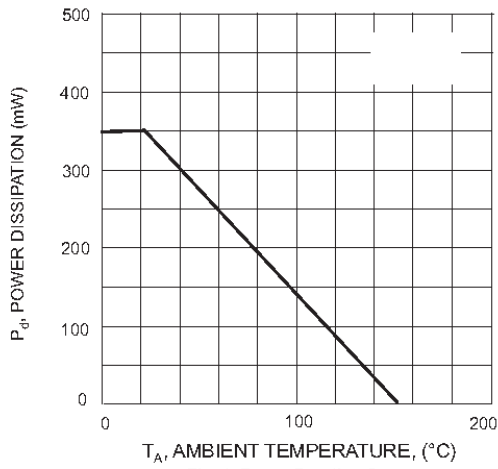

Fig. 1 Power Derating Curve

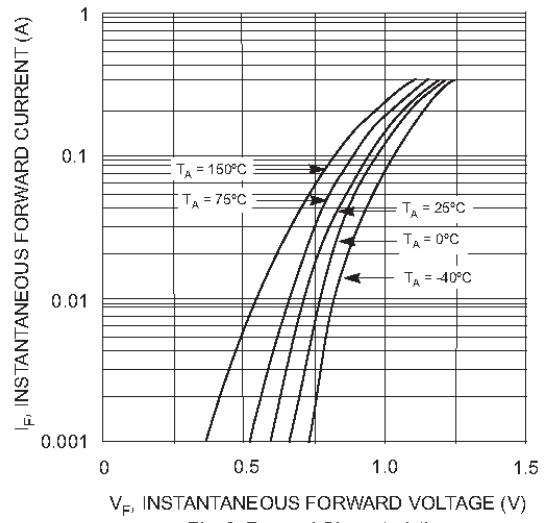

Fig. 2 Forward Characteristics

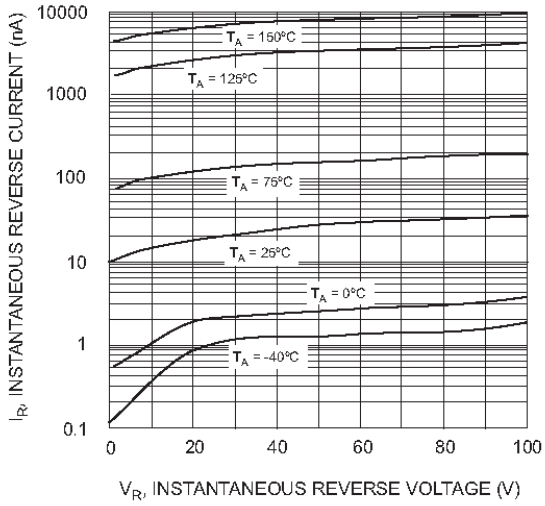

Fig. 3 Typical Reverse Characteristics

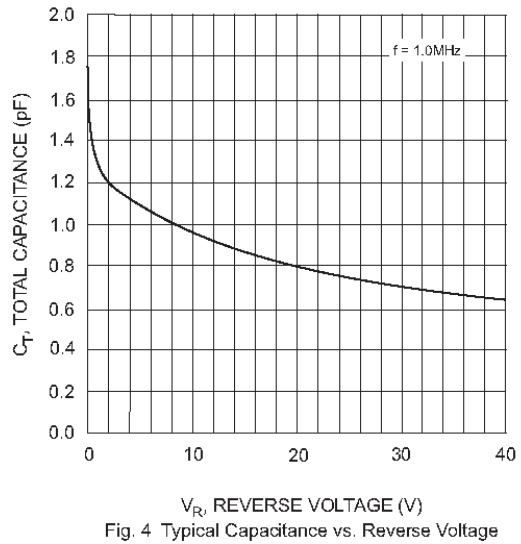

Fig. 4 Typical Capacitance vs. Reverse Voltage



PACKAGE OUTLINE

Plastic surface mounted package; 3 leads

SOT-23

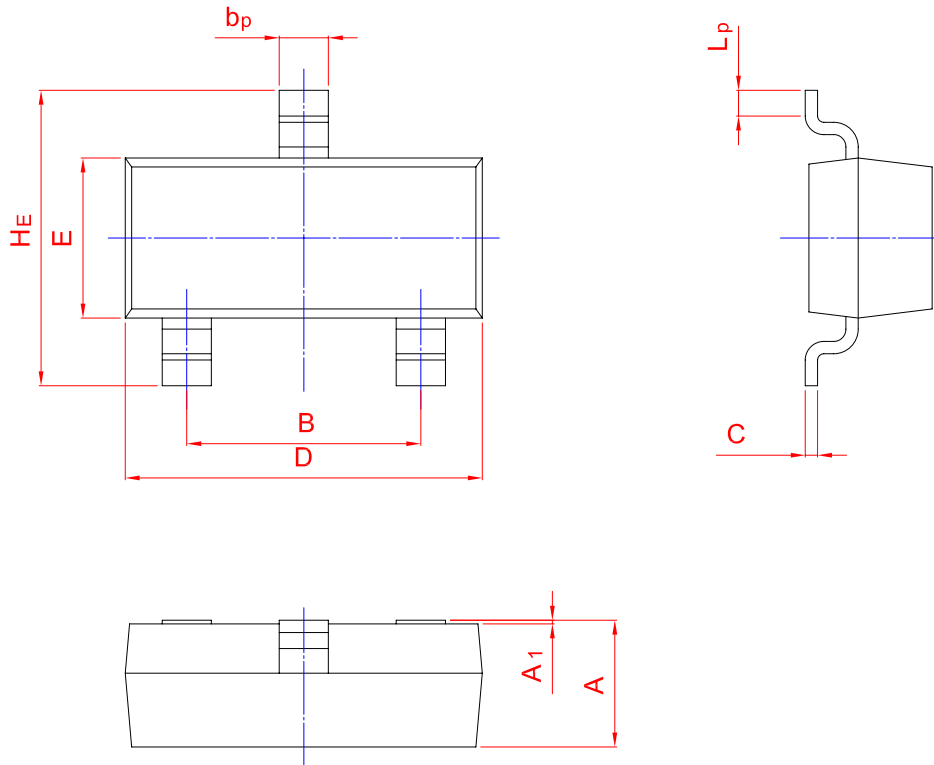
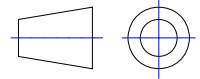

UNIT	A	B	b_p	C	D	E	$H\epsilon$	A_1	L_p
mm	1.40	2.04	0.50	0.19	3.10	1.65	3.00	0.100	0.50
	0.95	1.78	0.35	0.08	2.70	1.20	2.20	0.013	0.20