

Features

- Input voltage: up to 30V
- Output: 5V
- Output current up to 100 mA, internal thermal overload protection and short-circuit limiting.

3-Terminal Voltage Regulator

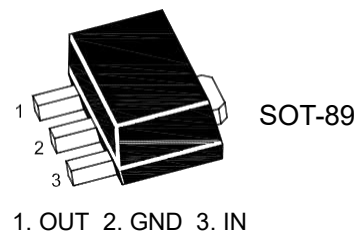

Maximum Ratings

Ratings at $T_A = 25^\circ\text{C}$ ambient temperature unless otherwise specified.

Parameter	Symbols	Value	Units
Input Voltage	V_I	30	V
Output Current	I_O	100	mA
Junction Temperature	T_J	150	$^\circ\text{C}$
Operating Temperature Range	T_{OPR}	-40~125	$^\circ\text{C}$
Power Dissipation	P_D	500	mW
Storage Temperature Range	T_{STG}	-55~150	$^\circ\text{C}$

Electrical Characteristics

Ratings at $T_A = 25^\circ\text{C}$ ambient temperature unless otherwise specified.

Parameter	Symbols	Test Conditions	Min	Typ	Max	Unit
Output Voltage	V_O	$I_O = 40\text{mA}$ $T_J = 25^\circ\text{C}$	4.80	5.0	5.2	V
		$I_O = 1\text{mA to } 40\text{mA}$ $V_I = 7\text{V to } 20\text{V}$	4.75	5.0	5.25	V
		$I_O = 1\text{mA to } 70\text{mA}$ $V_I = 10\text{V}$	4.75	5.0	5.25	V
Line Regulation	ΔV_O	$V_I = 7\text{V to } 20\text{V}$ $T_J = 25^\circ\text{C}$		32	150	mV
		$V_I = 8\text{V to } 20\text{V}$ $T_J = 25^\circ\text{C}$		26	100	mV
Load Regulation	ΔV_O	$I_O = 1\text{mA to } 100\text{mA}$ $T_J = 25^\circ\text{C}$		15	60	mV
		$I_O = 1\text{mA to } 40\text{mA}$ $T_J = 25^\circ\text{C}$		8	30	mV
Ripple Rejection	RR	$V_I = 8\text{V to } 18\text{V}$ $T_J = 25^\circ\text{C}$ $f = 120\text{Hz}$	41	49		dB
Output Noise Voltage	eN	$f = 10\text{Hz} \sim 100\text{KHz}$ $T_J = 25^\circ\text{C}$		42		μV
Dropout Voltage	V_D	$T_J = 25^\circ\text{C}$		1.7		V
Quiescent Current	I_Q	$T_J = 25^\circ\text{C}$		3.8	6	mA
		$T_J = 125^\circ\text{C}$			5.5	mA
Quiescent Current Change	ΔI_Q	$V_I = 8\text{V to } 20\text{V}$			1.5	mA
		$I_O = 1\text{mA to } 40\text{mA}$			0.1	mA

Ratings and Characteristic Curves

3-Terminal Voltage Regulator

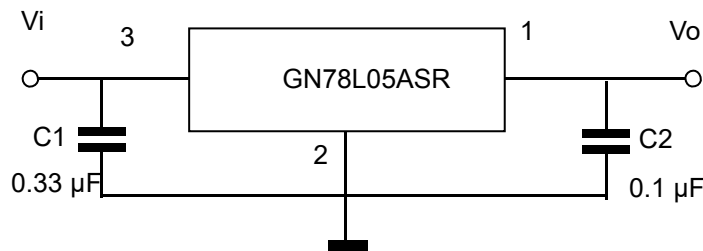
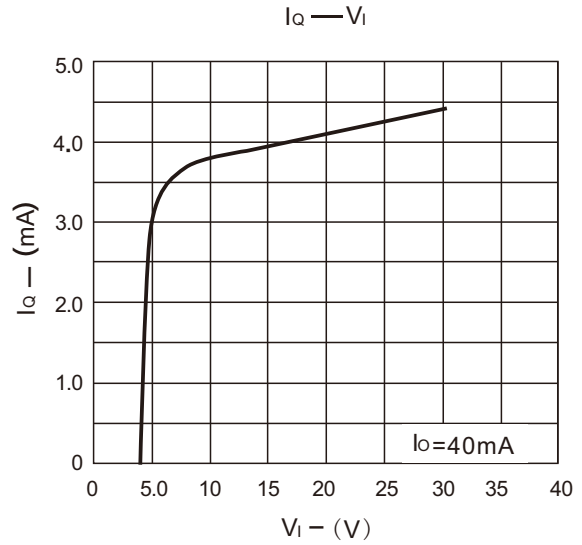
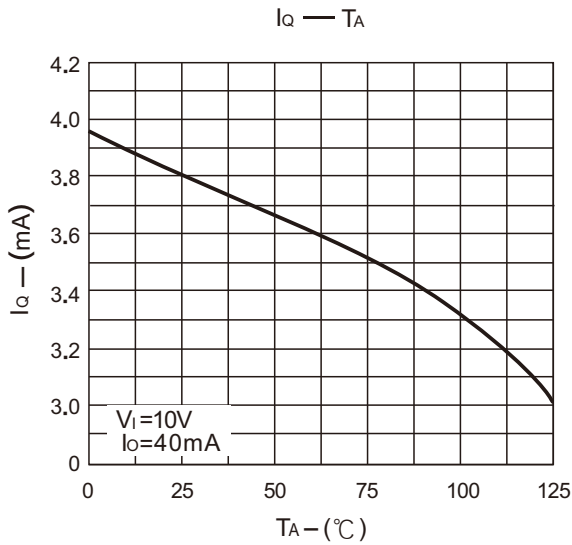
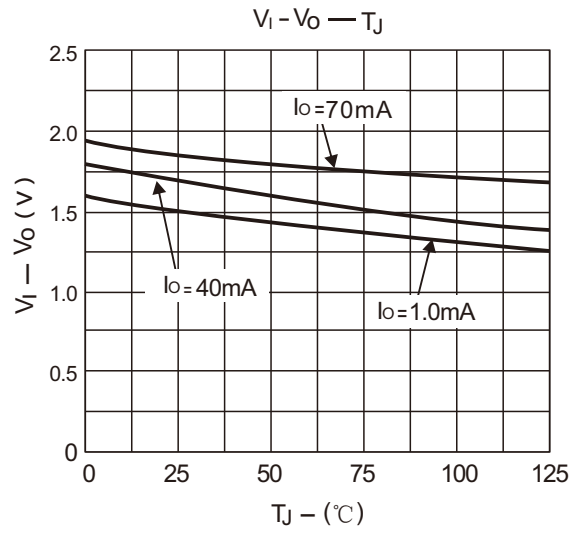
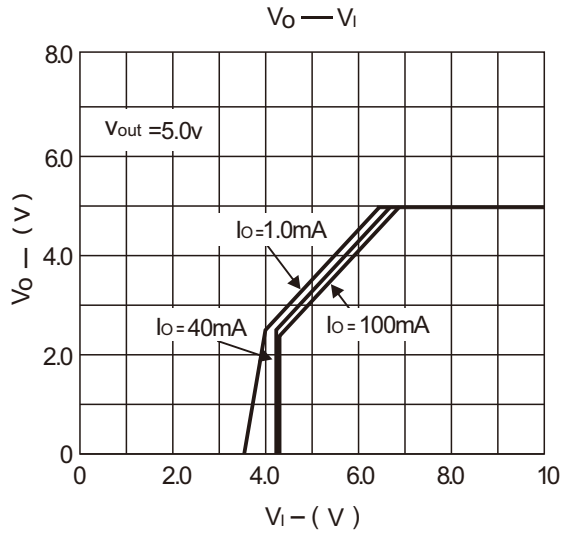

Package Outline

SOT-89

Dimensions in mm

3-Terminal Voltage Regulator

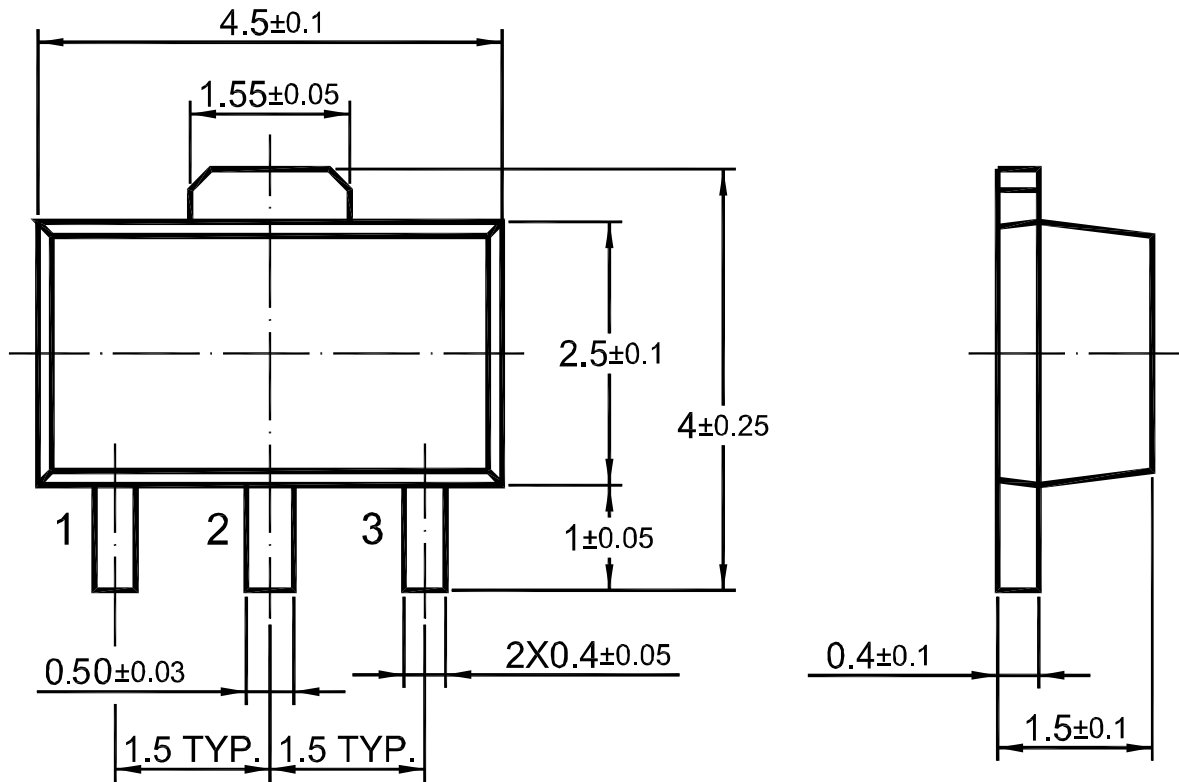

Ordering Information

Device	Package	Shipping
GN78L05ASR	SOT-89	1,000/ Tape & Reel (7 inches)