

# 产品规格书

## SPECIFICATION

产品名称	石英晶体谐振器
Description	Crystal Unit
型号 · 标称频率	
Type · Nominal Frequency	2016 32.000MHZ
规格书号	
Specification .	JFWSE32009A104C

制作

DESIGNED BY 杨 阳

审核

CHECKED BY 何 珍

批准

APPROBED BY 肖 琳

1.外观 · 印字

**Outline and Marking**

型号 Type	SMD Crystal 2016
外形尺寸图 Outline and Dimensions	附图 1 Drawing 1
印字示意图 Marking	附图 2 Drawing 2
回流焊温度曲线图 Reflow Temp. Profile	附图 3 Drawing 3

2.电气性能

**Electrical Performance**

标称频率 Nominal Frequency	32.000MHz
振荡模式 Mode of Oscillation	Fund
负载电容 Load Capacitance	9pF
存储温度范围 Storage Temperature	-55°C ~ +125°C
工作温度范围 Operating Temperature	-20°C ~ +70°C
频率公差 Frequency Tolerance	±10ppm
温度频差 Frequency Temperature Stability	±20PPM
并联电容 C0 Shunt Capacitance	2PF MaX
激励功率 Level of Drive	100uW MaX
老化率 Aging	±3ppm/year
绝缘电阻 Insulation Resistance	>500MΩ
谐振电阻 RR Equivalent Resistance	40Ω MaX

**3.机械性能**

**Mechanical Performance**

冲击(自由落体) Shock (Random Drop)	下落高度 Height: 75mm 下落次数 Dropped Time: 3 自由落体到硬质木板(30mm) Rigid Hardwood Surface	频率变化量 Frequency change permitted±3 ppm 等效串联阻抗所允许的变化量 Equivalent series resistance change permitted:±5Ω or ±10% 两者选最大 whichever is the large
回流焊耐热性 Thermal Stability of Solder	参考图 3	
气密性 Leakage	细漏 Fine leak: Helium leak test *JIS C 6701 10.6	漏率 Leak rate 5*10 <sup>-8</sup> Pa.m <sup>3</sup> /sMAX

**4. 回流焊曲线图 SUGGESTED REFLOW PROFILE**

**Total time:200sec.Max.** (总时间: **200 秒** 最大)

**Solder melting point:220℃** (熔点 **220 ℃**)

Profiles Feature (特性)		Pb-Free Assembly
Average Ramp-up Rate(Ts max to Tp) 平均升温速度		3℃/second Max
Preheat 预热		
■ Temperature Min (Ts min) 最低温度		125℃
■ Temperature Max (Ts max) 最高温度		200℃
■ Time (ts min to ts max) 从最低到最高时间		(60~180) seconds
Time maintained above 维持上述时间		
■ Temperature(T1) 温度		217℃
■ Time(tp) 时间		(60~150) seconds
Peak/Classification Temperature(Tp) 最高点温度		260℃
Time within 5℃ of actual Peak Temperature(tp) 高温维持时间		(20~40) seconds
Ramp-down rate 降温速度		6℃/second max
Time 25℃ to Peak Temperature 从 25℃到最高温度的时间		8 minutes max
Suggest reflow times 建议 reflow 次数		3 Times max

5. 信赖度试验 RELIABILITY SPECIFICATIONS			
No	Test Item (测试项目)	Test Conditions (测试条件)	Reference (参考)
1	High Temperature High Humidity Storage (高温、高湿、储存)	Temperature: 85°C±3°C 温度: 85°C±3°C Relative Humidity: 85%RH 相对湿度: 85%RH Time: 96 Hours 时间: 96 小时	JIS C5023
2	High Temperature Storage (高温 储存)	Temperature: 125°C±3°C 温度: 125°C±3°C Time: 96 Hours 时间: 96 小时	MIL-STD-883 E Method
3	Low Temperature Storage (低温储存)	Temperature: -40°C±3°C 温度: -40°C±3°C Time: 96 Hours 时间: 96 小时	MIL-STD-883E Method 1013
4	Thermal Shock (温度冲击)	Temperature 1: -55°C±5°C 温度 1: -55°C±5°C Temperature 2: 85°C±5°C 温度 2: 85°C±5°C Temperature change between T1 and T2 5 min T1 和 T2 温度在 5 分钟内改变 10 cycles maintain T1 and T2 for 30 minutes each one 每次循环 30 分钟共 10 次	MIL-STD-202 F Method 107 Condition A
5	RESISTANCE TO SOLDER HEAT (耐焊接热)	Solder Temperature: 260°C±5°C 焊槽温度: 260°C±5°C Time: 10±1 Seconds 时间: 10±1 秒	MIL-STD-F Method 2E
6	Solderability (可焊性)	The solder pot temperature is 245±5°C, dwell time 245±5°C 焊锡槽浸润 5±0.5 秒	J-STD-002B
7	Drop Test (落下试验)	3 Times Free Fall from 75cm height table to 3cm thickness hard wood board 从 75cm 高度 3 次跌落到 3cm 厚硬质木板上	JIS C6701
8	MECHANICAL SHOCK (机械冲击)	Half sine wave, 1000 G 半正弦波, 加速度 1000G 3 Times for all 3 directions X、Y、Z 三个相互垂直方向各三次	MIL-STD-202F Method 213B
9	Vibration (机械振动)	Frequency Range: 10Hz~55Hz 频率范围: 10Hz~55Hz Amplitude: 0.75mm 振幅: 0.75mm	MIL-STD-883E Method 2007.3
10	Leakage Test (气密性)	Take measurements with a helium Leakage detector 氦质检漏 Leakage Rate ≤ 1×10 <sup>-3</sup> Pa cm <sup>3</sup> /s 漏率 ≤ 1×10 <sup>-3</sup> Pa cm <sup>3</sup> /s	MIL-STD-883E

( 图 1 )

Drawing 1 外形尺寸图

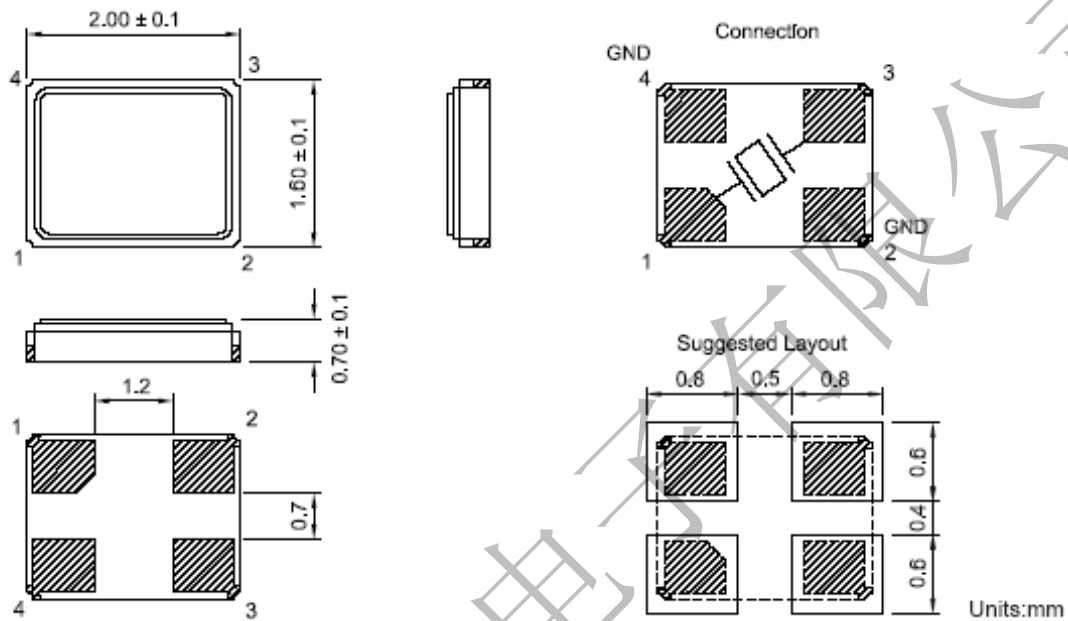

**包装规范:**

1)晶体编带方向有一致性。Pin1 必须要在 taping 圆洞的那一边。  
 The orientation of taping should be coherent. Pin1 must be at the side of hole.

2)印字的左下角是在 pin1 的上方。  
 Under left corner is the pin 1.

见下图

As follow

在装入晶体前必须至少留 300mm (40 个空格) 的空的载带, 并用胶膜封上。

料带尾端留 30cm 不放产品

胶膜尾端留 30~50cm

There should remain 30cm without XTAL  
 at the end of tape.

The end of adhesive tape should remain 30-50mm

(2)



(3)

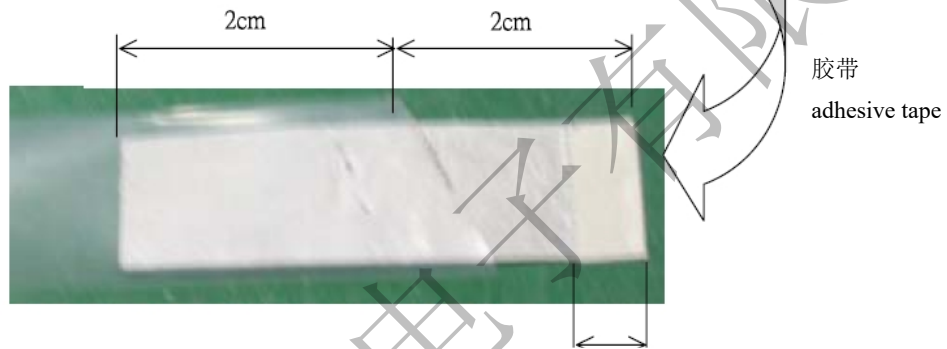

(4)

膠帶前端向下反折 1cm，以利拆卸  
 Make the adhesive tape backward  
 1cm in order to open conveniently.

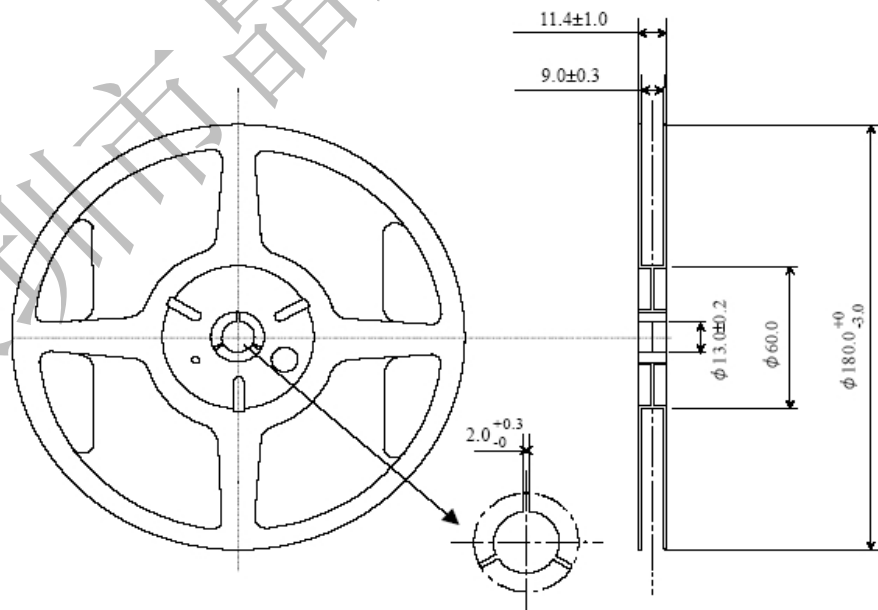

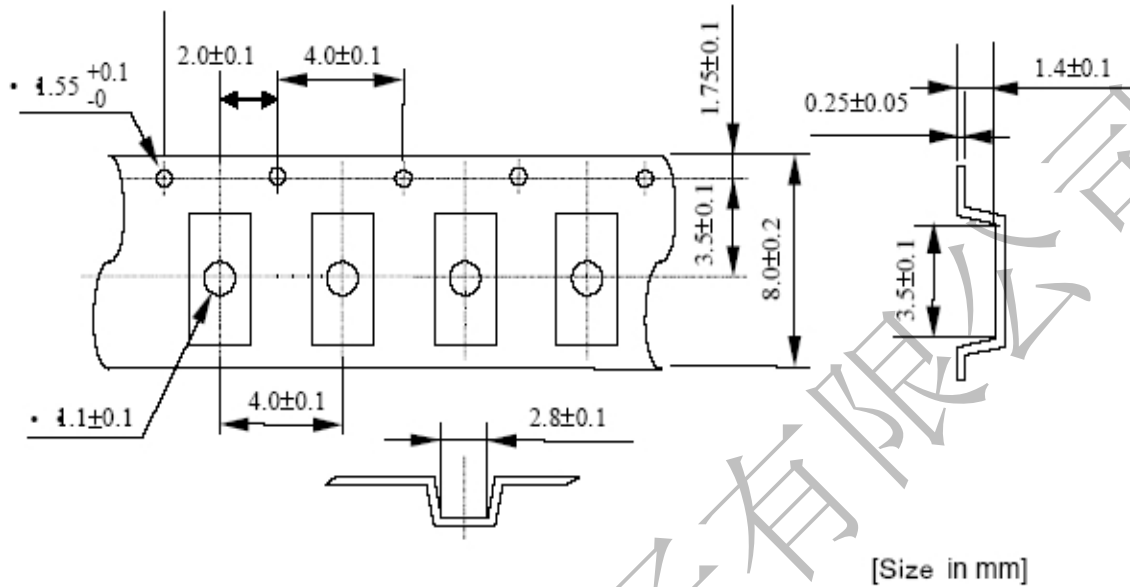

### 8.3. Reel dimension & Outline drawing

Material of the Reel : PS

料带拉力值: 30-60g。

Material belt pulling strength: 30-60g

a. 料带拉力测试角度:  $165^{\circ} \sim 180^{\circ}$ 。

Material belt pulling force test angle:  $165^{\circ} \sim 180^{\circ}$

b. 料带拉力测试速度: 300mm/min。

Material belt pulling force test speed: 300mm/min。

c. 料带拉力测试长度: 300mm。

Material belt pulling force test length

5. 在胶盘正面粘贴标签, 将胶盘放入气泡袋中, 将气泡袋塑封密闭。

Affix the label on the obverse side of reel, then put the reel into air bubble bag and seal it.

( 图 2 ) 印字示意图

Drawing 2

Marking

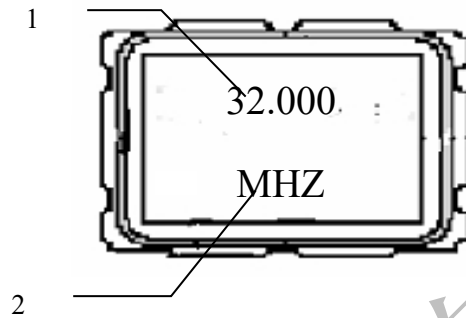

1. 标称频率: 取前4位数字

Nominal Frequency: XX.XXX

(eg.) 32.000000Mhz ----- 32.000

16.934400Mhz ----- 16.934

附: 产品电气参数验收依据: GB2828-87 一般检验水平 II AQL=0.4

Enclose: The product electricity parameter approval rests on GB2828-87 commonly test level II AQL=0.4

( 图 3 ) Drawing 3 回流焊曲线图

