

规格书

SPECIFICATION

产品名称	石英晶体谐振器
<u>Description</u>	<u>Crystal Unit</u>
型号 · 标称频率	
<u>Type · Nominal Frequency</u>	<u>49S 8.000MHZ</u>
规格书号	
<u>Specification .</u>	<u>JFWSI08020A204C</u>

制作
DESIGNED BY 杨 阳
审核
CHECKED BY 何 珍
批准
APPROBED BY 肖 琳

技术特性 Specification

1	标称频率 Nominal Frequency	8.000MHz
2	规格型号 Holder Type	HC-49S
3	振动模式 Mode of Oscillation	Fund AT
4	调整频差 Frequency Tolerance at (25°C ±2°C)	±20ppm
5	温度频差 Temperature Frequency Stability vs Temp	±20ppm
6	工作温度 Operating Temperature Range	-20~+70°C
7	贮存温度 Storage Temperature Range	-45~+80°C
8	负载电容 Load Capacitance	20pF
9	静电容 Shunt capacitance	<5PF (Max)
10	等效电阻 Equivalent Series Resistance	≤60 Ω (Max)
11	激励功率 Drive Level	100 u W
12	绝缘阻抗 Insulation Resistance	500M Ω at DC100V
13	年老化率 Aging Rate a Year	±5PPM

尺寸构造 Dimensions & Structure

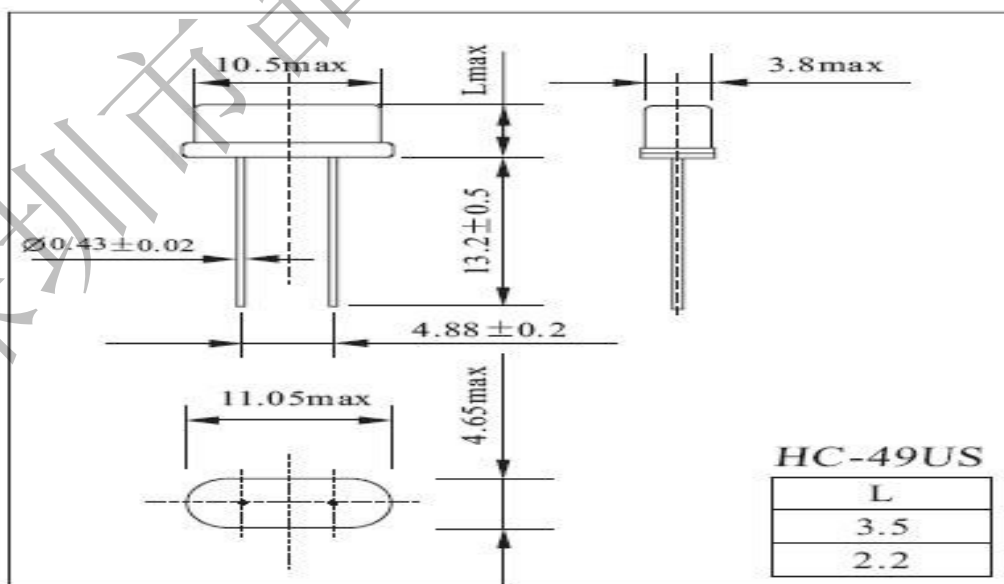

机械及环境性能 Environmental & Physical Characteristics

	Item	Condition	Standard
1.	Drop characteristics 跌落性	Free drop from 75cm height on a hard wooden board for 3 times. (Board is thickness more than 30 mm.)	Frequency change: ≤5ppm Rr as specification
2..	Shake characteristics 振动性	Shake frequency 10~55Hz, cycle 1~2 minutes, swing 1.5mm, direction x/y/z, all 30 minutes, test after 1 hours.	Frequency change: ≤5ppm Rr as specification
3.	Airproof characteristics 密封性	Put crystal into the pressure cabin with alcohol, keep pressure 0.4~0.5mpa 10 minutes, then take out and blow for 5 minutes	IR ≥ 500MΩ
4.	Weld characteristics 可焊性	260±5℃, 3 seconds	90% exhibit tin ok
5.	Bend characteristics 弯曲性	5N, 90°, 3 times, test machine	no damage
6.	Humidity characteristics 恒温性	+40±2℃ & 90%~95% R.H. 250 hours	Frequency change: ≤5ppm Rr as specification
7.	Low temperature characteristics 低温性	-30±2℃, 250 hours, put in room temperature, test after 1 hours.	Frequency change: ≤5ppm Rr as specification
8.	High temperature characteristics 高温性	+85±2℃, 250 hours, put in room temperature, test after 1 hours.	Frequency change: ≤5ppm Rr as specification

温度循环 Temperature cycling

Condition:

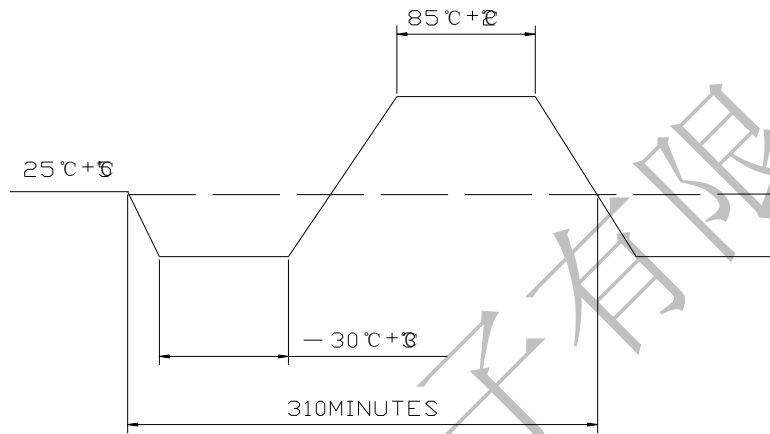

AFTER TEMPERATURE CYCLING

回流焊测试 Refluence examination

Condition:

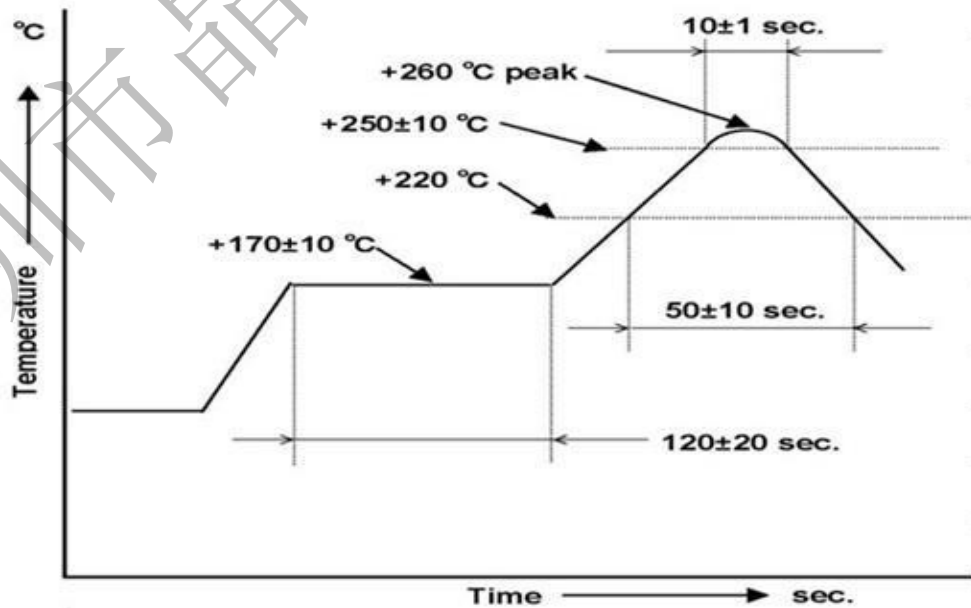

Dimension of Inside Package
内包装尺寸图

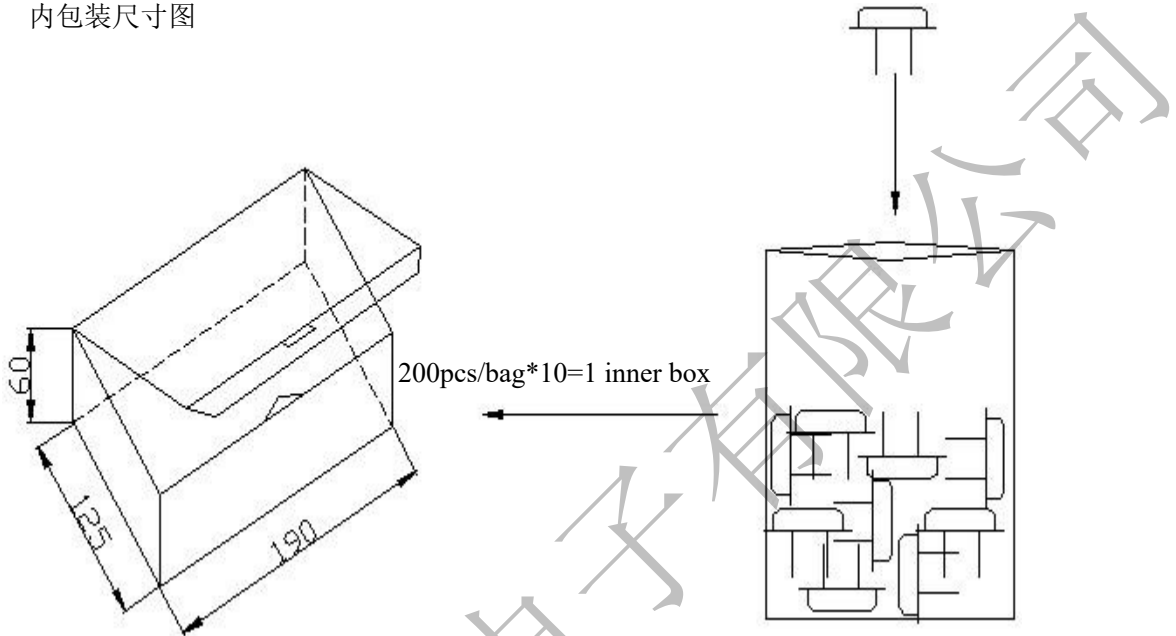

Dimensions of outside Package
外包装尺寸图

