

Description

The usblc6-2sc6 is a low capacitance ESD Array, utilizing leading monolithic silicon technology to provide fast response time and low ESD clamping voltage, making this device an ideal solution for protecting voltage sensitive high-speed data lines. The usblc6-2sc6 has an ultra low capacitance with a typical value at 0.4pF, and complies with the IEC 61000-4-2 (ESD) standard with $\pm 30\text{kV}$ air and $\pm 25\text{kV}$ contact discharge. It is assembled into a 6-pin lead-free SOT23-6 package. The low capacitance array makes it ideal for four high speed data and transmission lines. This device is optimized for ESD protection of portable electronics.

Mechanical Characteristics

- ◆ Package: SOT23-6
- ◆ Lead Finish: Matte Tin
- ◆ UL Flammability Classification Rating 94V-0
- ◆ Case Material: "Green" Molding Compound
- ◆ Moisture Sensitivity: Level 3 per J-STD-020
- ◆ Terminal Connections: See Diagram Below
- ◆ Marking Information: See Below

Dimensions and Pin Configuration

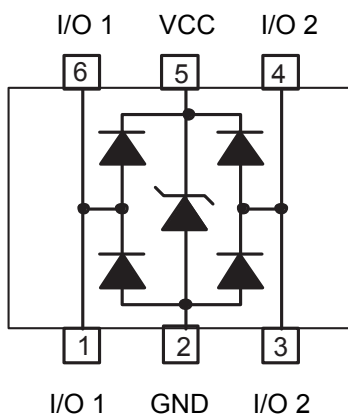

Circuit and Pin Schematic

Features

- ◆ Ultra low capacitance: 0.4pF typical (I/O to I/O)
- ◆ Ultra low leakage: nA level
- ◆ Low operating voltage: 5V
- ◆ Low clamping voltage
- ◆ 2 data lines and one power line protects
- ◆ Complies with following standards:
 - IEC 61000-4-2 (ESD) immunity test
 - Air discharge: $\pm 30\text{kV}$
 - Contact discharge: $\pm 25\text{kV}$
 - IEC61000-4-4 (EFT) 40A (5/50ns)
 - IEC61000-4-5 (Lightning) : 5A(8/20 μs)
- ◆ ROHS Compliant

Applications

- ◆ USB 2.0 Ports
- ◆ Digital video interface(DVI)
- ◆ Monitor and Flat Panel Displays
- ◆ Gigabit Ethernet

Marking Information

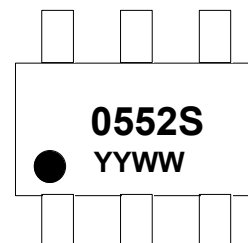

0552S = Device Marking Code

YYWW=Date Code

Dot denotes Pin1

Absolute Maximum Ratings ($T_A=25^{\circ}\text{C}$ unless otherwise specified)

Parameter	Symbol	Value	Unit
Peak Pulse Power (tp=8/20μs)	PPP	100	W
Peak Pulse Current (tp=8/20μs)	I _{PP}	5	A
ESD per IEC 61000-4-2 (Air)	V _{ESD}	±30	kV
ESD per IEC 61000-4-2 (Contact)		±25	
Operating Temperature Range	T _J	-55 to +125	°C
Storage Temperature Range	T _{stg}	-55 to +150	°C

Electrical Characteristics ($T_A=25^{\circ}\text{C}$ unless otherwise specified)

Parameter	Symbol	Min	Typ	Max	Unit	Test Condition
Reverse Working Voltage	V _{RWM}			5	V	
Breakdown Voltage	V _{BR}	6			V	I _T = 1mA
Reverse Leakage Current	I _R			0.5	μA	V _{RWM} = 5V
Clamping Voltage	V _C			10	V	I _{PP} = 1A (8 x 20μs pulse)
Clamping Voltage	V _C			20	V	I _{PP} = 5A (8 x 20μs pulse)
Junction Capacitance	C _J		0.6	0.8	pF	V _R = 0V, f = 1MHz, any I/O pin to ground
Junction Capacitance	C _J		0.3	0.4	pF	V _R = 0V, f = 1MHz, between I/O pins

Typical Performance Characteristics (TA=25°C unless otherwise Specified)

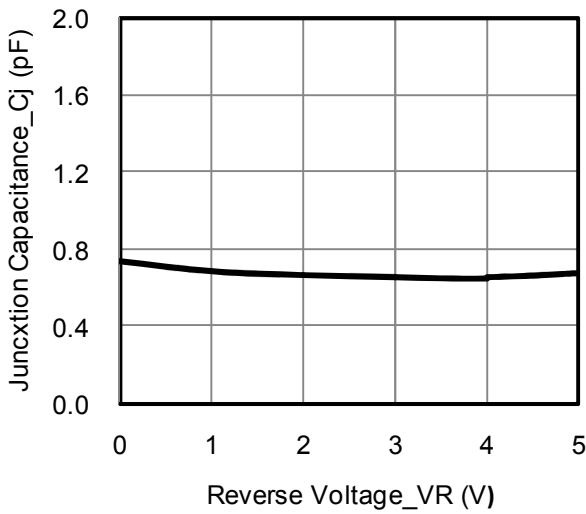

Junction Capacitance vs. Reverse Voltage

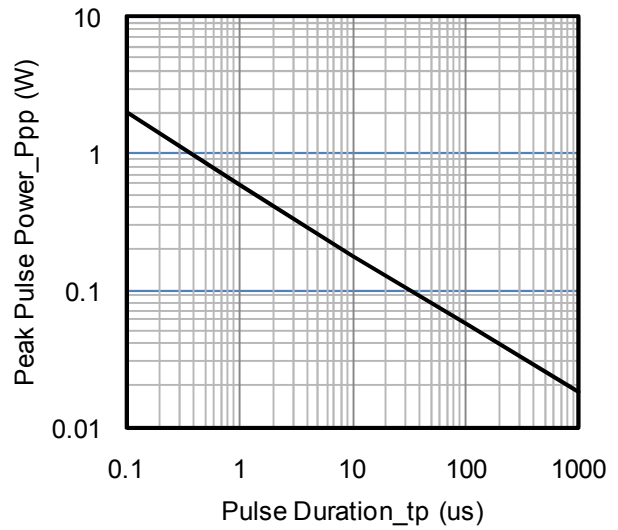

Peak Pulse Power vs. Pulse Time

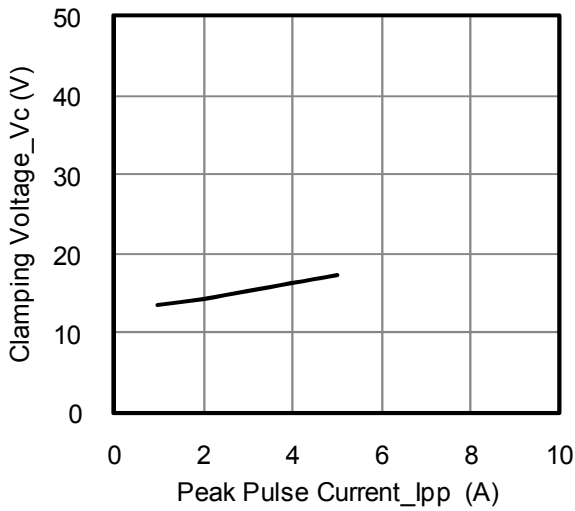

Clamping Voltage vs. Peak Pulse Current

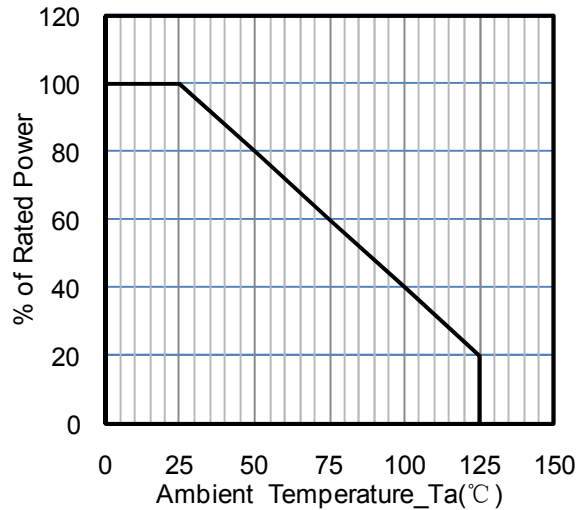

Power Derating Curve

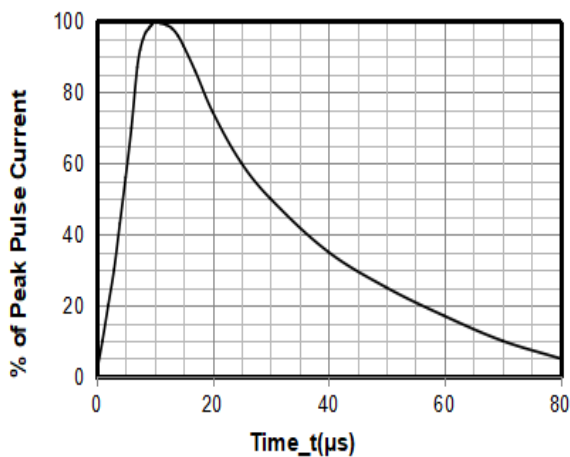

8 X 20µs Pulse Waveform

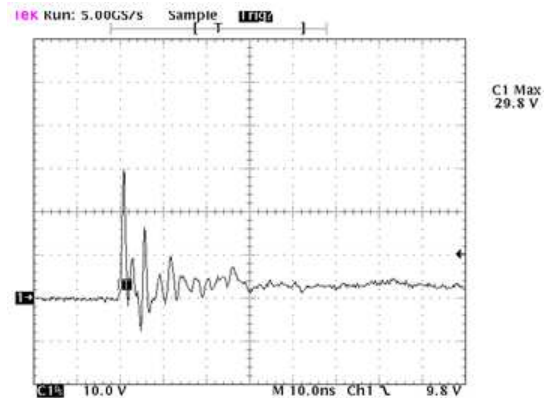

ESD Clamping Voltage

8 kV Contact per IEC61000-4-2

SOT23-6 Package Outline Drawing

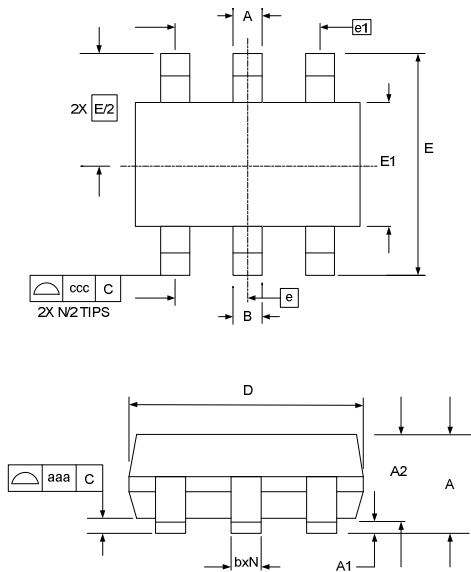

SYM	DIMENSIONS					
	MILLIMETERS			INCHES		
	MIN	NOM	MAX	MIN	NOM	MAX
A	0.90		1.45	0.035		0.057
A1	0.00		0.15	0.000		0.006
A2	0.90	1.15	1.30	0.035	0.045	0.051
b	0.25		0.50	0.010		0.020
c	0.08		0.22	0.003		0.009
D	2.80	2.90	3.10	0.110	0.114	0.122
E1	1.50	1.60	1.75	0.060	0.063	0.069
E	2.80 BSC			0.110 BSC		
e	0.95 BSC			0.037 BSC		
e1	1.90 BSC			0.075 BSC		
N	6			6		
aaa	0.10			0.004		
ccc	0.20			0.008		

Suggested Land Pattern

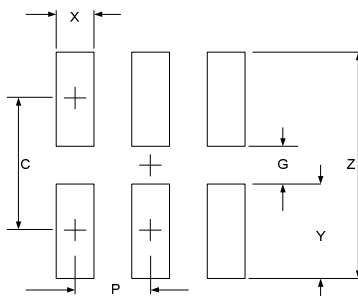

SYM	DIMENSIONS	
	MILLIMETERS	INCHES
C	2.50	0.098
G	1.40	0.055
P	0.95	0.037
X	0.60	0.024
Y	1.10	0.043
Z	3.60	0.141