

## RoHs Device Halogen Free

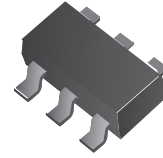

### Features

- Uni-directional ESD protection of four lines.
- IEC61000-4-2 Level 4 ESD protection.
- JESD22-A114-B ESD Rating of class 3B per human body model.
- Low reverse stand-off voltage: 5V
- Low reverse clamping voltage.
- Low leakage current.
- Fast response time.

### Mechanical data

- Case: SOT-23-6 standard package molded plastic.
- Terminals: Solder plated, solderable per MIL-STD-750,method 2026.
- Mounting position: Any
- Weight: 0.015 grams(approx.).

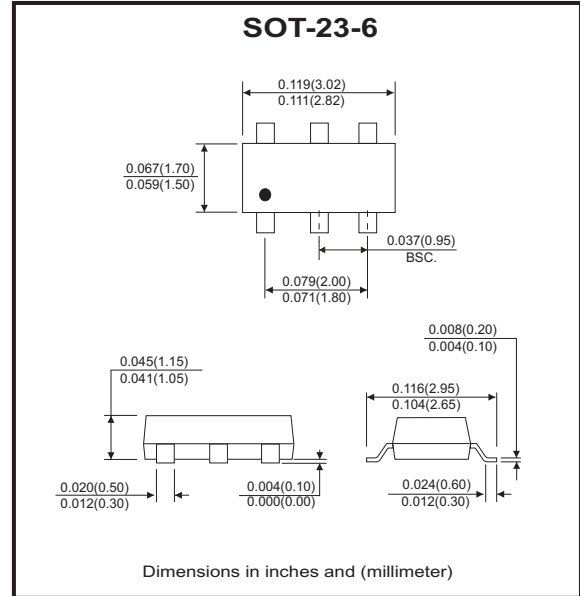

### Pin Configuration

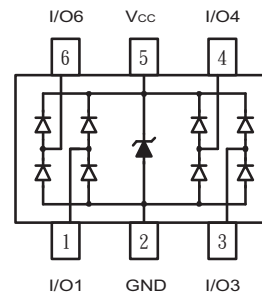

### Maximum Ratings (at TA=25°C unless otherwise noted)

Parameter	Symbol	Value	Unit
Peak pulse power	$P_{PP}^{(2)}$	125	W
Peak pulse current	$I_{PP}^{(2)}$	5	A
IEC 61000-4-2 voltage (I/O to GND & Vcc to GND)	Air model	±25	kV
	Contact model	±25	
JESD22-A114-B ESD voltage (I/O to GND & Vcc to GND)	$V_{ESD}^{(1)}$	±16	
ESD voltage (I/O to GND & Vcc to GND)		Machine Model	
Lead soldering temperature - Maximim(10 second duration)	$T_L$	260	°C
Junction temperature range	$T_j$	-55 to +150	°C
Storage temperature range	$T_{STG}$	-55 to +150	°C

Notes: 1. Device stressed with ten non-repetitive ESD pulses, Per channel (I/O to GND).

2. Non-repetitive current pulse 8/20µs exponential decay waveform according to IEC61000-4-5.

### Electrical Characteristics (at TA=25°C unless otherwise noted)

Parameter	Conditions	Symbol	Min	Typ	Max	Unit
Reverse stand-Off voltage		$V_{RWM}^{(1)}$			5	V
Breakdown voltage	$I_T = 1\text{mA}$	$V_{(BR)}$	6.5		8.8	V
	$I_T = 1\text{mA } V_{CC} \text{ to GND}$		5.8		8.1	V
Reverse leakage current	$V_{RWM} = 5\text{V}$ (I/O to GND & $V_{CC}$ to GND)	$I_R$			1	$\mu\text{A}$
Forward voltage	$I_F = 10\text{mA}$ (I/O to GND & $V_{CC}$ to GND)	$V_F$	0.5		1.0	V
Clamping voltage	$I_{PP} = 1\text{A}$ (I/O to GND & $V_{CC}$ to GND)	$V_C^{(2)}$			15	V
	$I_{PP} = 5\text{A}$ (I/O to GND & $V_{CC}$ to GND)				25	
Junction capacitance	$V_R = 0\text{V}, f = 1\text{MHz}$	$C_j$			2.0	pF
	$V_R = 0\text{V}, f = 1\text{MHz}, I/O \text{ to } I/O$				1.5	

Notes: 1. Other voltages available upon request.

2. Non-repetitive current pulse 8/20 $\mu\text{s}$  exponential decay waveform according to IEC61000-4-5.

### RATING AND CHARACTERISTIC CURVES (USBLC6-4SC6)

Fig.1 - 8/20us Peak Pulse Current  
Wave Form Acc. IEC 61000-4-5

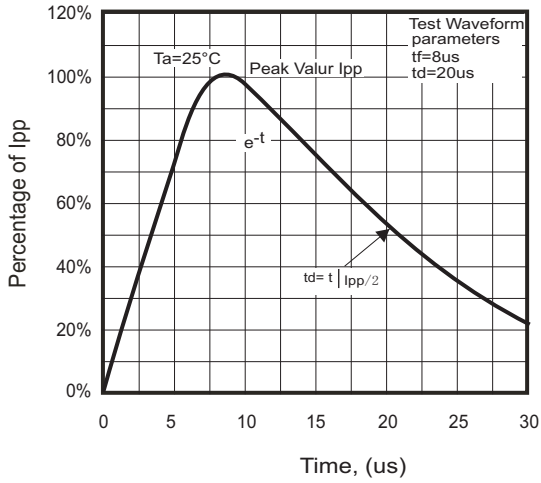

Fig.2 - Power Derating Curve

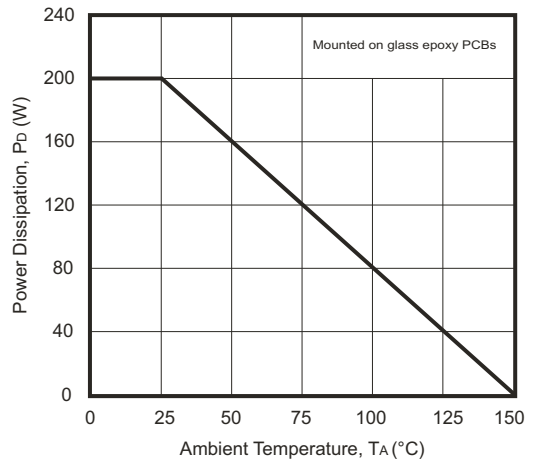

Fig.3 - Capacitance Characteristics

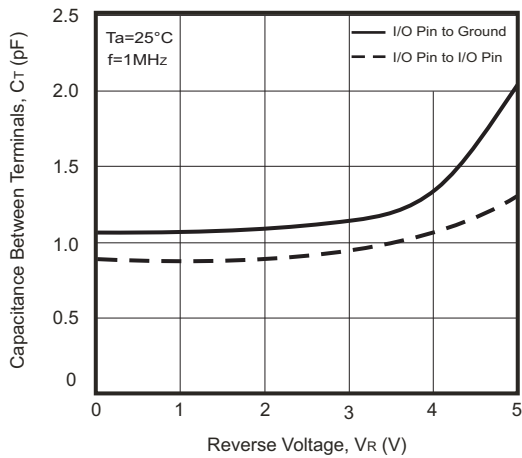
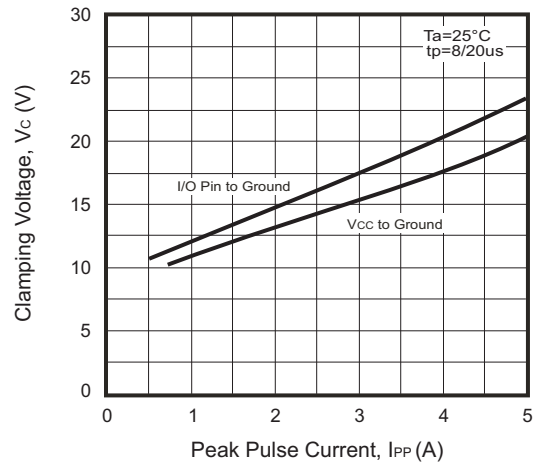
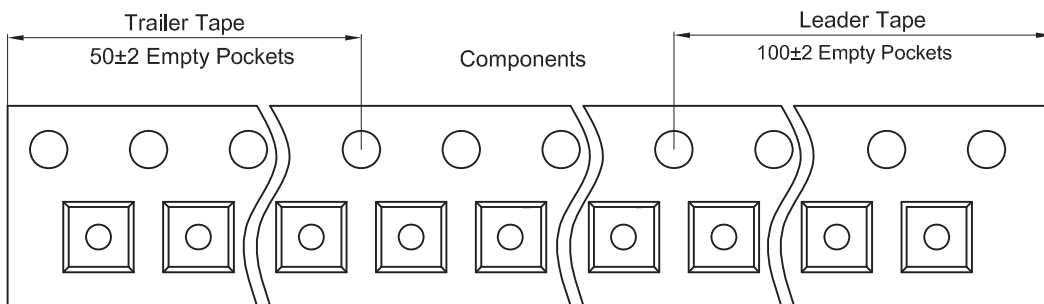
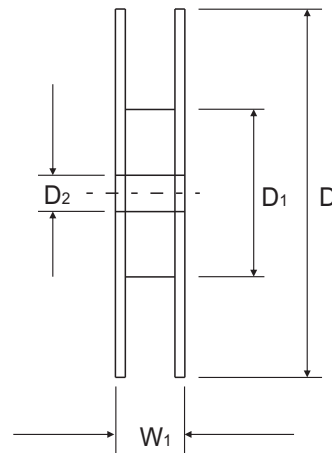
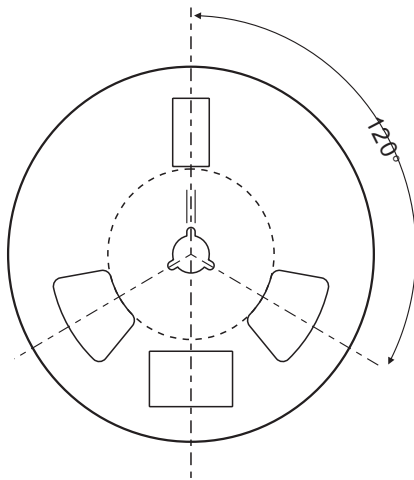
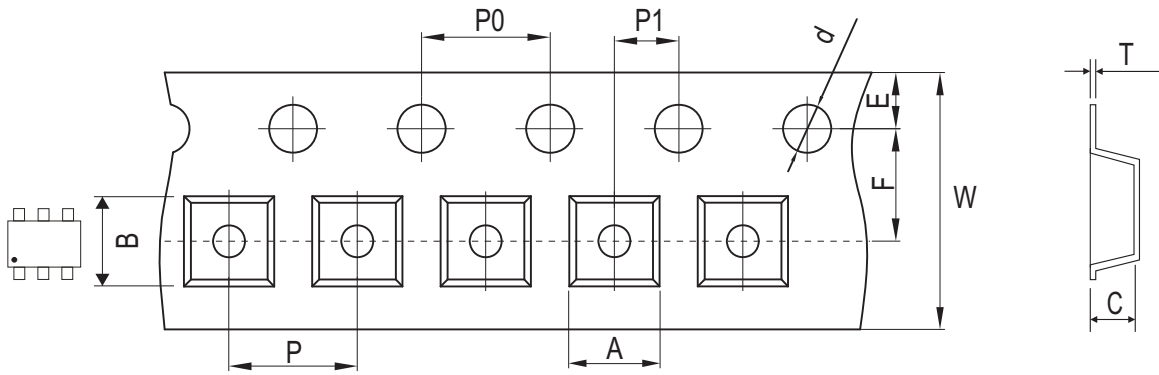

Fig.4 - Clamping Voltage Vs. Peak Pulse Current



### Reel Taping Specification



SOT-23-6	SYMBOL	A	B	C	d	D	D1	D2
	(mm)	3.17 ± 0.10	3.23 ± 0.10	1.37 ± 0.10	1.50 ± 0.05	180.0 + 0.00 / - 0.30	60.00 ± 0.50	13.00 ± 0.20
	(inch)	0.125 ± 0.004	0.127 ± 0.004	0.054 ± 0.004	0.059 ± 0.002	7.087 + 0.00 / - 0.012	2.362 ± 0.020	0.512 ± 0.008

SOT-23-6	SYMBOL	E	F	P	P0	P1	W	W1
	(mm)	1.75 ± 0.10	3.50 ± 0.05	4.00 ± 0.10	4.00 ± 0.10	2.00 ± 0.05	8.00 + 0.30 / - 0.10	12.30 ± 0.20
	(inch)	0.069 ± 0.004	0.138 ± 0.002	0.157 ± 0.004	0.157 ± 0.004	0.079 ± 0.002	0.315 + 0.012 / - 0.004	0.484 ± 0.008

### Suggested PAD Layout

SIZE	SOT-23-6	
	(mm)	(inch)
A	1.00	0.039
B	0.70	0.028
C	0.95	0.037
D	2.40	0.094
E	3.40	0.134

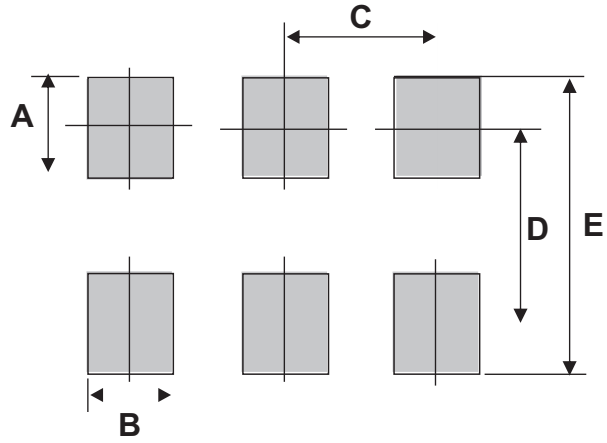

### Standard Packaging

Case Type	REEL PACK	
	REEL ( pcs )	Reel Size (inch)
SOT23-6	3,000	7