

# 产品规格书

## SPECIFICATION

产品名称	石英晶体谐振器
Description	Crystal Unit
型号 · 标称频率	
Type · Nominal Frequency	206 12.000MHz
规格书号	
Specification .	JFWSG12010A104C

制作

DESIGNEDBY 杨 阳

审核

CHECKEDBY 何 珍

批准

APPROBEDBY 肖 琳

# JF 深圳市晶发电子有限公司 SHENZHEN JINGFA ELECTRONICS CO., LTD

石英晶体谐振器（柱状）

RoHS Compliant Standard

TDXLF-206-12.000MHz10PF

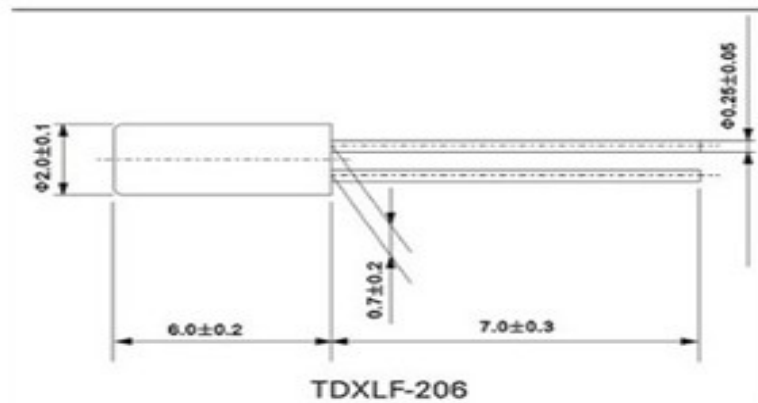

## STANDARD SPECIFICATIONS 標準規格

标称频率 Nominal Frequency	12.000MHz
负载电容 Load Capacitance	10pF
工作温度范围 Operating Temperature	-20℃ ~ +70℃
频率公差 Frequency Tolerance	±10ppm 25℃
温度频差	±10PPM (-20~+70 之间)
等效阻抗	<80 Ω
激励电平 Level of Drive	50 U W
绝缘电阻:	50M (插脚间加 DC100V ± 5V)
年老化率 Aging	±5ppm/year
静电容	<5PF

可靠性 1 Reliability (Mechanical and Environmental Endurance)

Page 1 of 2

NO	Test Items	Test Method and Condition	Requirements
1	振動 Vibration	(1)振動頻 Vibration Frequency 10 to 55Hz (2)振動幅度 Vibration Amplitude 1.5mm (3)周期 Cycle Time 1-2min(10-55-10Hz) (4)振動方向 Direction X.Y.Z (5)振動時間 Duration 2h/each direction	頻率變化最大:±10ppm 覆蓋 The dipped surface of the leads should be at least 95% covered with continuous new solder coating
2	衝擊 Shock	從 75cm 高的地方自由跌落 3 次到 30mm 厚的硬木板上 3 Times free drop from 75cm height to hard wooden board of thickness more than 30mm	頻率變化最大: ±10ppm Frequency Change: ±10ppm Max. 電阻變化最大: 5kohm Resistance Change: 5kohm Max.
3	氣密性 Leakage	晶體放入氦加壓罐內, 充入氦氣壓力 0.5-0.6Mpa 保持 1 小時;然後使用氦質譜檢漏儀測試。Put crystal units into a hermetic container and Helium for 0.5-0.6Mpa, and keep it for 1h; Check the leakage by a Helium leak detector	漏氣率小於: $1 \times 10^{-8}$ mbar.l/s Leakage: $1 \times 10^{-8}$ mbar.l/s Max.
4	可焊性 Solder ability	將引線浸入完全熔化的焊錫鍋內 3-5s, 焊錫溫度 $245^{\circ}\text{C} \pm 5^{\circ}\text{C}$ Put the leads of crystal units into solder melted tank for 3 to 5s Temperature of solder melted tank is $245^{\circ}\text{C} \pm 5^{\circ}\text{C}$	浸過引線面積的 95% 以上被新焊錫覆蓋 The dipped surface of the leads should be at least 95% covered with continuous new solder coating
5	手工焊接耐熱 Soldering iron resistance	$350^{\circ}\text{C} \pm 10^{\circ}\text{C}$ , 3+1/-0 sec	頻率變化最大: ±10ppm Frequency Change: ±10ppm Max. 電阻變化最大: 10kohm Resistance Change: 10kohm Max.

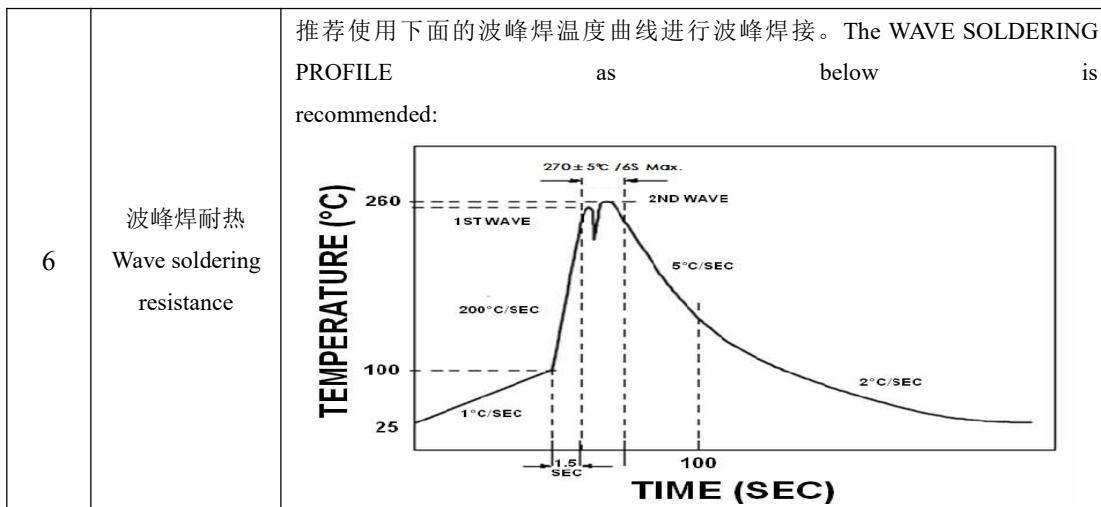

### 可靠性 2 Reliability (Mechanical and Environmental Endurance)

No	Test Items	Test Method and Condition	Requirements
7	引線強度 (引線直插式晶體) Lead Strength (DIP)	用 0.9kg(9N)的力持續拉晶體引線 30s ± 5s; 用 0.45kg 的力折引線成 90° 2次 (折弯处离机体 1.5mm 以上); The crystal lead with the 0.9kg(9N) power (keep it for 30s ± 5s) and bend the crystal lead 90° with 0.45kg power and two times (which you want to bend should be more than 1.5mm from the case)	引線無異常 The crystal lead is not a bnormity
8	耐高溫能力 High Temperature Endurance	晶體放置於 85°C ± 2°C 環境中 2 小時後, 常溫放置 1-2 小時 The crystal units shall be put in somewhere for 2 hours at temperature of 85°C ± 2°C, then keep it for 1 to 2 hours under room temperature	頻率變化最大: ±10ppm Frequency Change: ±10ppm Max. 電阻變化最大: 5kohm Resistance Change: 5kohm Max.
9	耐低溫能力 Low Temperature Endurance	晶體放置於 -25°C 環境中 2 小時後, 常溫放置 1-2 小時 The crystal units shall be put in somewhere for 2 hours at temperature of -25°C, then keep it for 1 to 2 hours under room temperature	
10	耐濕性 Humidity Endurance	晶體放置於 40°C、相對濕度 90-95% 環境中 48 小時後, 常溫放置 1-2 小時 The crystal units shall be put in somewhere at 40°C in relative humidity of 90-95% for 48 hours, then keep it for one or two hours under room temperature	
11	高低溫迴圈 Temperature Cycle	溫度從 -40°C (保持 30 分鐘) 升高到 100°C (保持 30 分鐘), 再降到 -40°C (保持 30 分鐘) 然後回到室溫 25°C 完成一個迴圈, 共計 5 個迴圈 Temperature shift from low (-40°C) to high (100°C, keep 30 minutes), satisfy high (100°C) to low (-40°C, keep 30	

		minutes),then go up to room temperature for 5 cycles	
12	鹽霧試驗 Salt Spray Test	晶體置於鹽霧濃度5%,溫度35℃的鹽霧室中96小時後,用水洗淨擦幹表面 Put the crystal units in the salt spray room(salt density:5%)at the temperature of 35℃ for 96 hours.Then clean it with water and dry its surface.	外觀良好,可焊性良好 The appearance shall has no ab norm i t y and soldering is good.頻率變化最大:±10ppm Frequency Change: ±10ppm Max.電阻變化最大 :5kohm Resistance Change:5kohm Max.

**使用說明 Processing Instructions**

下面的說明和資訊供用戶正確理解和使用我們公司的石英晶體系列產品,預防不當的加工方式,對石英晶體的損壞,確保用戶設備的可靠性。

**The following instructions and information are provided for the purpose of having the user understand the proper way to process our crystal products to prevent problems prior to use and enhance the reliability of the equipment to which they are applied.**

No.	PROCESSING INSTRUCTIONS
1	<p><b>石英晶體意外跌落 When dropped by mistake</b></p> <p>設計和製造的石英晶體本身具有耐衝擊能力,但是當石英晶體元件經受劇烈的機械衝擊,如跌落到地板上或安裝期間劇烈震動時,在使用之前需要進行電性能確認</p> <p>The crystal units are designed and manufactured to resist physical shocks.However,when the crystal units are subjected to excessive impact such as being dropped onto the floor or giving shocks during processing,need to make sure its satisfactory performance before using it.</p>

2	<p><b>焊接 Soldering</b></p> <p>(1)使用電烙鐵焊接時,引線應該在 4 秒內焊接完畢,電烙鐵溫度不能高於 350°C Lead wires should be soldered within 4 seconds with the soldering iron heated to a temperature no higher than 350°C</p> <p>(2)使用浸錫方式焊接時,引線應該在 10 秒內焊接完畢,焊錫溫度不能高於 260°C,並且注意不能將整個晶體浸錫.推薦使用垂直安裝方式,避免熱力直接傳導到晶體上 In solder-dip processing,the leads should be soldered within 10 seconds with a temperature no higher than 260°C.Mounting in upright is recommendable to prevent the heat conduction directly to the body of the crystal unit.</p> <p>(3)使用波峰焊接時,請參照下面的波峰焊溫度曲線 The WAVE SOLDERING PROFILE as below is recommended for TDXLF-308 tuning fork crystal resonators.</p> <div style="text-align: center;"> </div>
---	---

**使用說明 Processing Instructions**

No.	PROCESSING INSTRUCTIONS
3	<p><b>石英晶體彎腳 TO BEND THE LEAD of cylinder type products</b></p> <p>(1)當圓柱狀晶體元件需要彎腳時,為了防止彎腳時造成密封玻璃體的破裂,從彎腳處到晶體基座底部距離應大於 1.5mm。推薦距離 3.0mm,並使用工裝夾具進行彎腳。When the lead of cylinder type crystal units need to be bent,leave more than 1.5mm (3.0mm is recommendable) of lead from the case in order to prevent from any cracks of the hermetic sealing glass at the root of the lead,and use a jig to bend if possible.</p> <p>(2)當圓柱狀晶體元件進行彎腳時,不要剝離引線的鍍層 When bending the lead of cylinder type crystal units,do not scrape off the soldering plating from the lead surface.</p>

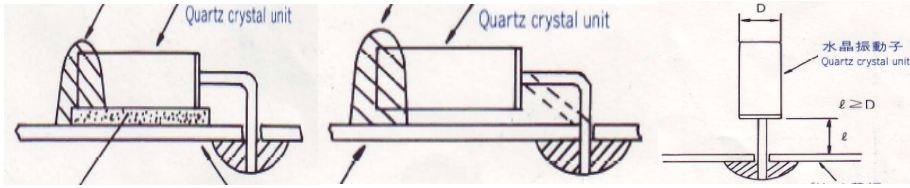
4	<p><b>元件的安裝 MOUNTING</b></p> <p>(1)為了避免影響元件電性能或損壞元件，嚴禁將圓柱狀晶體元件外殼焊接在印製板上進行固定。推薦使用橡膠粘結劑進行固定 Soldering the body of the cylinder type crystal units with PCB must be</p>  <p>(2)當用手工來彎曲引線時，請遵照下列方法 When the lead needs to be bent by hand, please follow the instruction as below:用手指捏住圓柱晶體的外殼;用鑷子夾住引線要彎曲的部位，該部位離晶體基座底部 1.5mm 以上（推薦 3.0mm）;用鑷子夾住彎曲引線成 90°，不要用力拉引線。用力拉引線可能造成引線根部的玻璃子破裂，而產生漏氣損壞元件電性能。Hold the body of the cylinder type crystal unit in fingers; Pick at the part with tweezer, which you want to bend. There should be more than 1.5mm (3.0mm is recommended) from the body case; Bend the lead 90° by tweezer without pulling the lead strongly. If pulling the lead strongly may cause any cracks of hermetic sealing glass at the root of the lead and may cause the leakage and the characteristics to deteriorate.</p>
5	<p><b>石英晶體元件的清洗 CLEANING</b></p> <p>(1)惡劣的超聲波清洗或超聲波焊接可能會影響和損壞石英晶體元件。如果您對晶體元件進行了超聲波清洗，請一定在使用前確認晶體元件是否受到了影響和損壞 Crystal units may be affected and destroyed at worst by supersonic cleaning or supersonic welding. Please be sure to check if your cleaning and welding process affects any damage to crystal units before using.</p> <p>(2)有些清洗液也可能造成晶體元件的損壞，請在使用清洗液前確認該清洗液是否適用 Some kinds of cleaning fluid may cause any damage to crystal units. Please be sure to check suitability of the cleaning fluid in advance</p>
6	<p><b>貯存 STORAGE</b></p> <p>石英晶體元件長時間貯存在高溫或高濕環境中，可能會影響頻率的穩定性或可焊性。請將晶體元件貯存在正常的溫度和濕度環境中，避免陽光直射和露水凝結，避免貯存 6 個月以上再使用，拆封後儘快裝配使用。Storage of crystal units under higher temperature or high humidity for a long term may affects frequency stability or solderability. Please store the crystal units under the normal temperature and humidity without exposing to direct sunlight and dew condensation</p>

**包裝 PACKING**

**Packing For Pb Free Parts:**

**1. INNER BOX: (Unit: mm)**

10bags X 1000pcs = 10000pcs/box

1000pcs/bag

# JF 深圳市晶发电子有限公司 SHENZHEN JINGFA ELECTRONICS CO., LTD

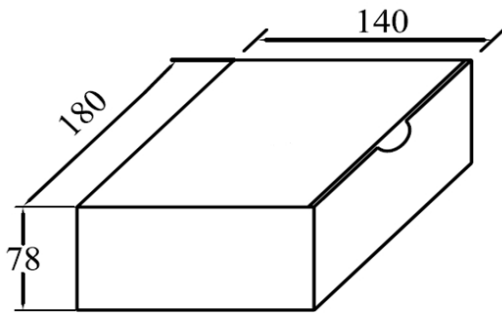
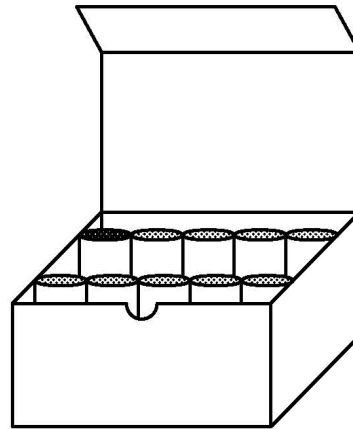
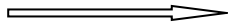
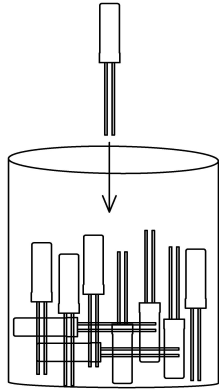

客供品进料检验标签

厂 商			

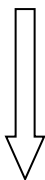

10 INNER BOX x 10000 pcs = 100000 pcs

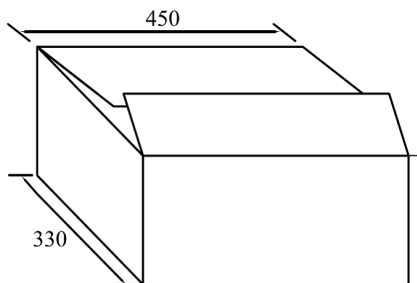

Revision	A	Revised	A	initial release
Date	6-Feb.-2016	records	C	
Issued by		Hold Type	206	