



MUR460

SUPERFAST RECOVERY RECTIFIERS

VOLTAGE 600 Volt **CURRENT** 4 Ampere

DO-201AD Unit: inch(mm)

FEATURES

- Superfast recovery times-epitaxial construction
- Low forward voltage, high current capability
- Hermetically sealed
- Low leakage
- High surge capability
- Plastic package has Underwriters Laboratories Flammability Classification 94V-O utilizing Flame Retardant Epoxy Molding Compound.
- Lead free in compliance with EU RoHS 2.0

MECHANICAL DATA

- Case: Molded plastic, DO-201AD
- Terminals: Axial leads, solderable to MIL-STD-750, Method 2026
- Polarity: Color band denotes cathode end
- Approx. Weight: 0.0396 ounce, 1.122 gram

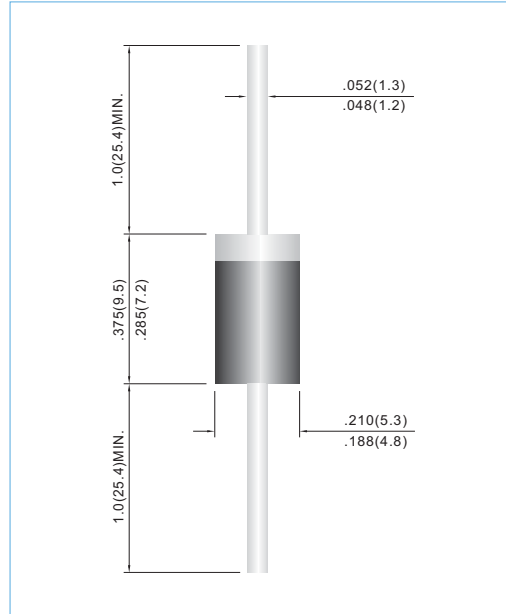

MAXIMUM RATINGS AND ELECTRICAL CHARACTERISTICS

Ratings at 25°C ambient temperature unless otherwise specified.
Resistive or inductive load, 60Hz.

PARAMETER	SYMBOL	MUR460	UNITS
Maximum Recurrent Peak Reverse Voltage	V_{RRM}	600	V
Maximum RMS Voltage	V_{RMS}	420	V
Maximum DC Blocking Voltage	V_{DC}	600	V
Maximum Average Forward Current .375" (9.5mm) lead length at $T_A=55^\circ\text{C}$	$I_{F(AV)}$	4.0	A
Peak Forward Surge Current : 8.3ms single half sine-wave superimposed on rated load (JEDEC method)	I_{FSM}	125	A
Maximum Forward Voltage at 4.0A	V_F	1.28	V
Maximum DC Reverse Current at Rated DC Blocking Voltage $T_A=25^\circ\text{C}$ Maximum DC Reverse Current at Rated DC Blocking Voltage $T_A=125^\circ\text{C}$	I_R	5 300	μA
Maximum Reverse Recovery Time (Note 1)	t_{rr}	50	ns
Typical Junction capacitance (Note 2)	C_J	35	pF
Typical Thermal Resistance (Note 3)	$R_{\theta JA}$ $R_{\theta JC}$	20 13	$^\circ\text{C} / \text{W}$
Operating and Storage Temperature Range T_J, T_{STG}	T_J, T_{STG}	-55 to +150	$^\circ\text{C}$

NOTES: 1. Reverse Recovery Test Conditions: $I_F=.5\text{A}$, $I_R=1\text{A}$, $I_{rr}=.25\text{A}$
2. Measured at 1 MHz and applied reverse voltage of 4.0 VDC
3. Thermal resistance from junction to ambient and from junction to lead length 0.375" (9.5mm) P.C.B. mounted



MUR460

RATING AND CHARACTERISTIC CURVES

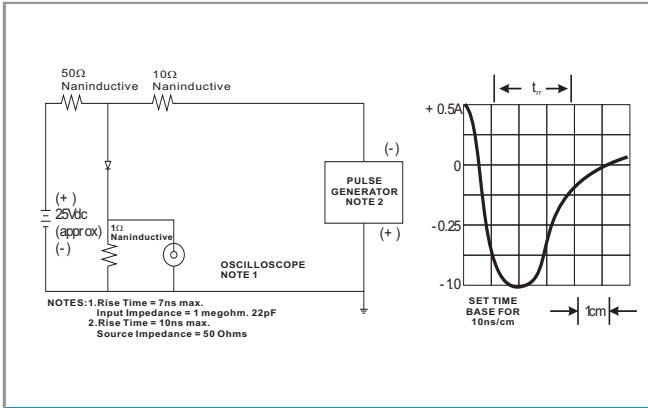

FIG.1 REVERSE RECOVERY TIME CHARACTERISTIC AND TEST CIRCUIT DIAGRAM

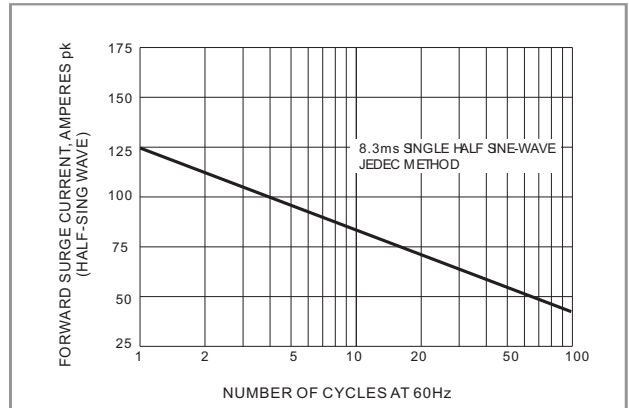

FIG.2 MAXIMUM NON-REPEITIVE SURGE CURRENT

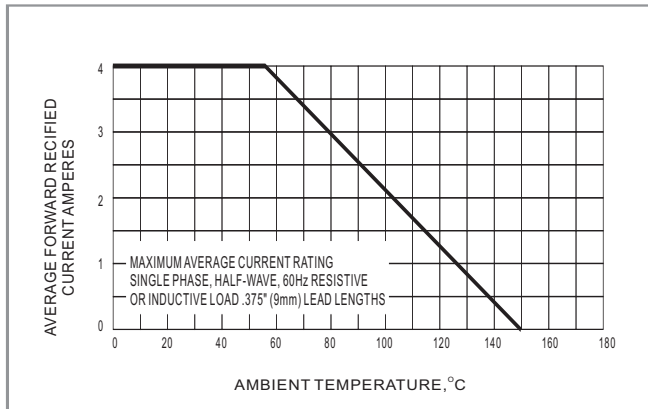

FIG.3 MAXIMUM AVERAGE FORWARD CURRENT RATING

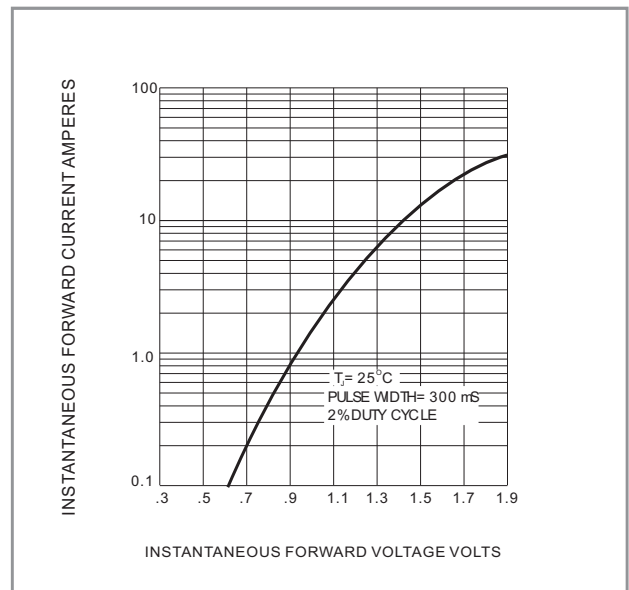

FIG.4 TYPICAL JUNCTION CAPACITANCE

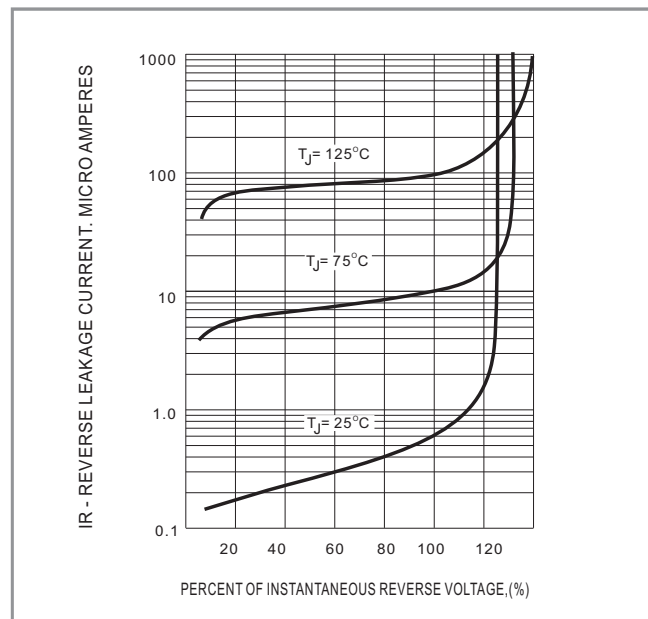

FIG.5 TYPICAL REVERSE CHARACTERISTICS

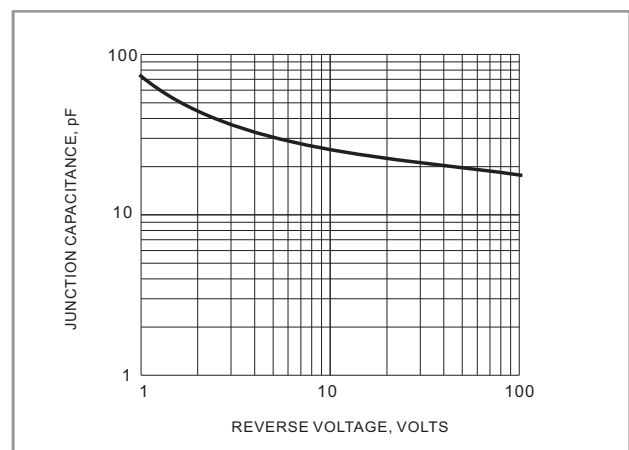

FIG.6 TYPICAL JUNCTION CAPACITANCE



MUR460

Part No. Packing Code Version

Part No. Packing Code	Package Type	Packing Type	Marking	Version
MUR460_AY_00101	DO-201AD	1250pcs / Ammo	MUR460	Halogen free
MUR460_B0_00101	DO-201AD	500pcs / Box	MUR460	Halogen free
MUR460_R2_00101	DO-201AD	1250pcs / 13" reel	MUR460	Halogen free



MUR460

Disclaimer

- Reproducing and modifying information of the document is prohibited without permission from Panjit International Inc..
- Panjit International Inc. reserves the rights to make changes of the content herein the document anytime without notification. Please refer to our website for the latest document.
- Panjit International Inc. disclaims any and all liability arising out of the application or use of any product including damages incidentally and consequentially occurred.
- Panjit International Inc. does not assume any and all implied warranties, including warranties of fitness for particular purpose, non-infringement and merchantability.
- Applications shown on the herein document are examples of standard use and operation. Customers are responsible in comprehending the suitable use in particular applications. Panjit International Inc. makes no representation or warranty that such applications will be suitable for the specified use without further testing or modification.
- The products shown herein are not designed and authorized for equipments requiring high level of reliability or relating to human life and for any applications concerning life-saving or life-sustaining, such as medical instruments, transportation equipment, aerospace machinery et cetera. Customers using or selling these products for use in such applications do so at their own risk and agree to fully indemnify Panjit International Inc. for any damages resulting from such improper use or sale.
- Since Panjit uses lot number as the tracking base, please provide the lot number for tracking when complaining.