

## 500mA, Low Dropout, Low Noise, Ultra-Fast Linear Regulator

### General Description

The RT9065 is designed for portable RF and wireless applications with demanding performance and space requirements. The RT9065 performance is optimized for battery powered systems to deliver ultra low noise and low quiescent current. A noise bypass pin is available for further reduction of output noise. Regulator ground current increases only slightly in dropout, further prolonging the battery life. The RT9065 also works with low-ESR ceramic capacitors, reducing the amount of board space necessary for power applications, critical in hand held wireless devices. The RT9065 consumes less than 0.01 $\mu$ A in shutdown mode and has fast turn-on time less than 10 $\mu$ s. The other features include low dropout voltage, high output accuracy, current limiting protection, and high ripple rejection ratio. The RT9065 is available in the SOT-23-6 package.

### Ordering Information

RT9065 □ □

- Package Type  
E : SOT-23-6
- Lead Plating System  
G : Green (Halogen Free and Pb Free)

Note :

Richtek products are :

- ▶ RoHS compliant and compatible with the current requirements of IPC/JEDEC J-STD-020.
- ▶ Suitable for use in SnPb or Pb-free soldering processes.

### Features

- Ultra-Low-Noise for RF Application
- Ultra-Fast Response in Line/Load Transient
- Quick Start-Up (Typically 10 $\mu$ s)
- 0.01 $\mu$ A Shutdown Current
- Low Dropout : 370mV @ 500mA
- Wide Input Voltage Range : 2.2V to 5.5V
- Adjustable Output Voltage
- TTL Logic Controlled Shutdown Input
- Low Temperature Coefficient
- Current Limiting Protection
- Thermal Shutdown Protection
- Only 1 $\mu$ F Output Capacitor Required for Stability
- High Power Supply Rejection Ratio
- RoHS Compliant and Halogen Free

### Applications

- CDMA/GSM Cellular Handsets
- Battery Powered Equipment
- Laptop, Palmtops, Notebook Computers
- Hand Held Instruments
- PCMCIA Cards
- Portable Information Appliances

### Marking Information

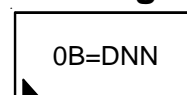

0B= : Product Code  
DNN : Date Code

### Simplified Application Circuit

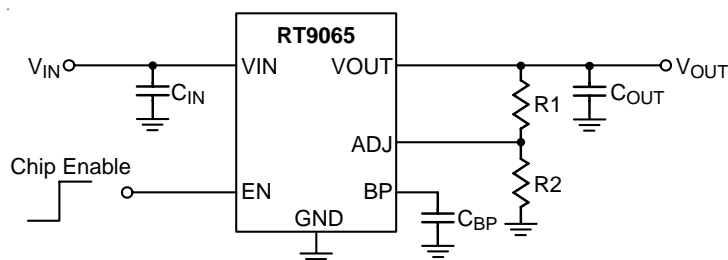

Pin Configurations

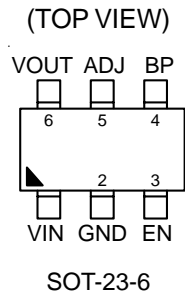

Functional Pin Description

Pin No.	Pin Name	Pin Function
1	VIN	Power Input.
2	GND	Ground.
3	EN	Chip Enable (Active High). Note that this pin is high impedance. There should be a pull-low 100kΩ resistor connected to GND when the control signal is floating.
4	BP	Reference Noise Bypass.
5	ADJ	Feedback Input. Connect a resistive divider to adjust the output voltage.
6	VOUT	Output of the Regulator.

Function Block Diagram

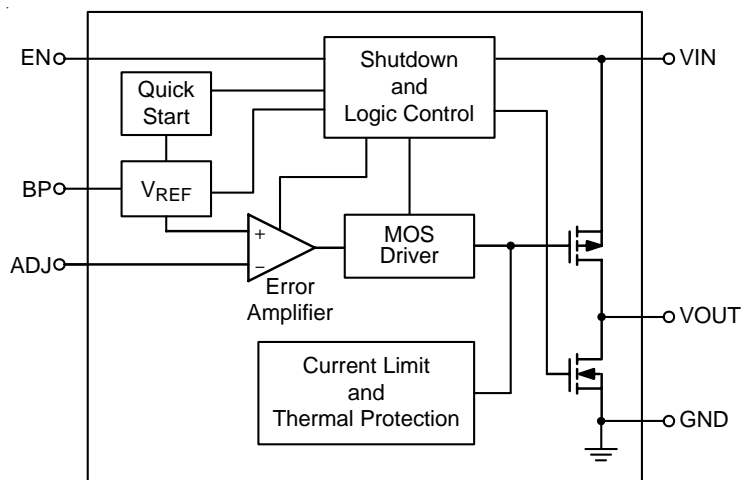

## Operation

The RT9065 is a low dropout voltage linear regulator designed for RF and wireless applications which require low noise and high PSRR performance. The RT9065 builds in a P-type P-MOSFET with current capability up to 500mA. In normal operation, the Error Amplifier adjusts the gate voltage of the power MOSFET to regulate the ADJ voltage being equal to the internal 0.8V reference voltage.

P-MOSFET current is detected and current limit function will work to limit the output current to a designed value when short circuit happens. Furthermore, the P-MOSFET will be shutdown if the junction temperature is higher than typically 165°C, and released to normal operation until the temperature falls below typically 135°C.

### Quick Start

This function is designed to achieve internal reference voltage quick ramping up during chip turning on or power on.

### Shutdown and Logic Control

This function block includes chip Enable/Disable and UVLO circuits. When chip is disabled, VOUT is pulled to GND through the auto-discharge MOSFET.

## Absolute Maximum Ratings (Note 1)

- Supply Voltage,  $V_{IN}$  ----- -0.3V to 6V
- Chip Enable Input Voltage,  $V_{EN}$  ----- -0.3V to 6V
- Output Voltage,  $V_{OUT}$  ----- -0.3V to 6V
- Adjust Output,  $ADJ$  ----- -0.3V to 6V
- Power Dissipation,  $P_D$  @  $T_A = 25^\circ C$   
 SOT-23-6 ----- 0.48W
- Package Thermal Resistance (Note 2)  
 SOT-23-6,  $\theta_{JA}$  ----- 208.2°C/W
- Lead Temperature (Soldering, 10 sec.) ----- 260°C
- Storage Temperature Range ----- -65°C to 150°C
- Junction Temperature ----- 150°C
- ESD Susceptibility (Note 3)  
 HBM (Human Body Model) ----- 2kV  
 MM (Machine Model) ----- 200V

## Recommended Operating Conditions (Note 4)

- Supply Voltage,  $V_{IN}$  ----- 2.2V to 5.5V
- Junction Temperature Range ----- -40°C to 125°C
- Ambient Temperature Range ----- -40°C to 85°C

## Electrical Characteristics

( $V_{IN} = V_{OUT} + 1V$ ,  $C_{IN} = 2.2\mu F$ ,  $C_{OUT} = 1\mu F$ ,  $C_{BP} = 22nF$ ,  $T_A = 25^\circ C$ , unless otherwise specified)

Parameter	Symbol	Test Conditions	Min	Typ	Max	Unit
ADJ Reference Voltage	$V_{ADJ}$	$V_{IN} = 5V$ , $I_{OUT} = 100mA$	0.788	0.8	0.812	V
Shutdown Current	$I_{SHDN}$	$V_{EN} = GND$	--	0.01	1	$\mu A$
Quiescent Current	$I_Q$	$I_{OUT} = 0mA$	--	90	120	$\mu A$
Dropout Voltage	$V_{DROP}$	$I_{OUT} = 300mA$	--	220	300	mV
		$I_{OUT} = 500mA$	--	370	500	
Line Regulation	$\Delta V_{LINE}$	$V_{IN} = (V_{OUT} + 1V)$ to 5.5V, $I_{OUT} = 1mA$	--	--	0.3	%
Load Regulation	$\Delta V_{LOAD}$	$1mA < I_{OUT} < 500mA$	--	--	0.6	%
EN Input Bias Current	$I_{IBSD}$	$V_{EN} = GND$ or $V_{IN}$	--	0	100	nA
EN Input Voltage	Logic-High	$V_{IH}$	1.2	--	--	V
	Logic-Low	$V_{IL}$	--	--	0.4	
Output Noise Voltage	$e_{NO}$	10kHz to 100kHz, $I_{OUT} = 200mA$ , $C_{OUT} = 1\mu F$	--	100	--	$\mu V_{RMS}$
Power Supply Rejection Rate	$f = 100Hz$	$PSRR$ $C_{OUT} = 1\mu F$ , $I_{OUT} = 10mA$	--	70	--	dB
	$f = 10kHz$		--	50	--	
Under Voltage Lockout Threshold	$V_{UVLO}$	$V_{IN}$ Rising	1.6	1.8	2	V

Parameter	Symbol	Test Conditions	Min	Typ	Max	Unit
Under Voltage Lockout Hysteresis	$\Delta V_{UVLO}$		0.1	0.15	--	V
Current Limit	$I_{LIM}$	$R_{LOAD} = 1\Omega$	500	650	--	mA
Thermal Shutdown Threshold	$T_{SD}$		--	165	--	°C
Hysteresis	$\Delta T_{SD}$		--	30	--	°C

**Note 1.** Stresses beyond those listed “Absolute Maximum Ratings” may cause permanent damage to the device. These are stress ratings only, and functional operation of the device at these or any other conditions beyond those indicated in the operational sections of the specifications is not implied. Exposure to absolute maximum rating conditions may affect device reliability.

**Note 2.**  $\theta_{JA}$  is measured at  $T_A = 25^\circ\text{C}$  on a high effective thermal conductivity four-layer test board per JEDEC 51-7.

**Note 3.** Devices are ESD sensitive. Handling precaution recommended.

**Note 4.** The device is not guaranteed to function outside its operating conditions.

## Typical Application Circuit

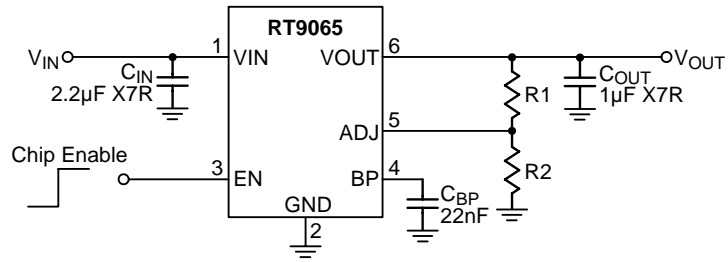

**Typical Operating Characteristics**

**ADJ Reference Voltage vs. Temperature**

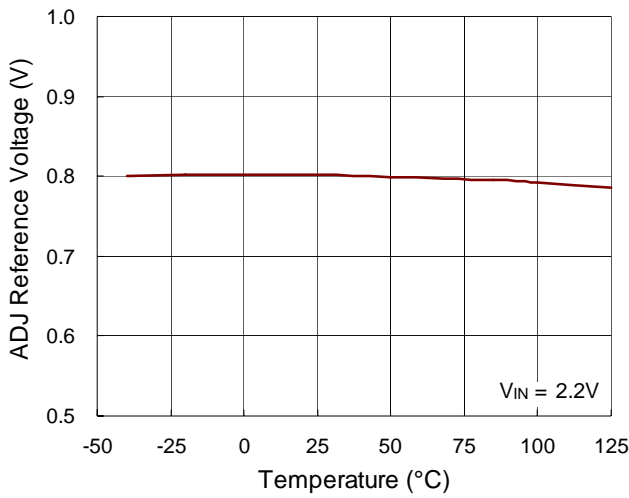

**Quiescent Current vs. Temperature**

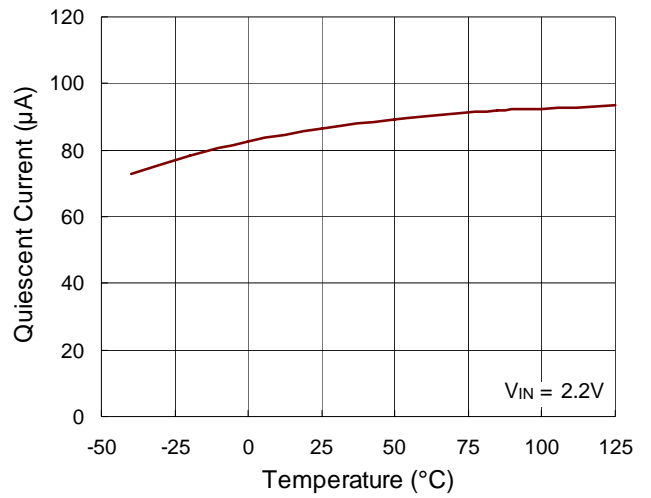

**Dropout Voltage vs. Temperature**

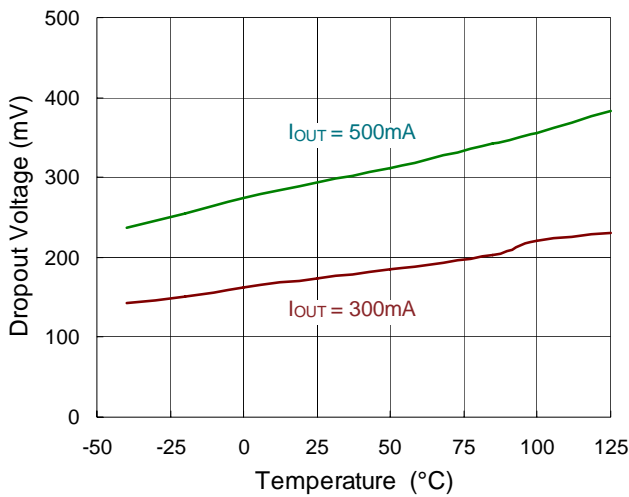

**Start-Up**

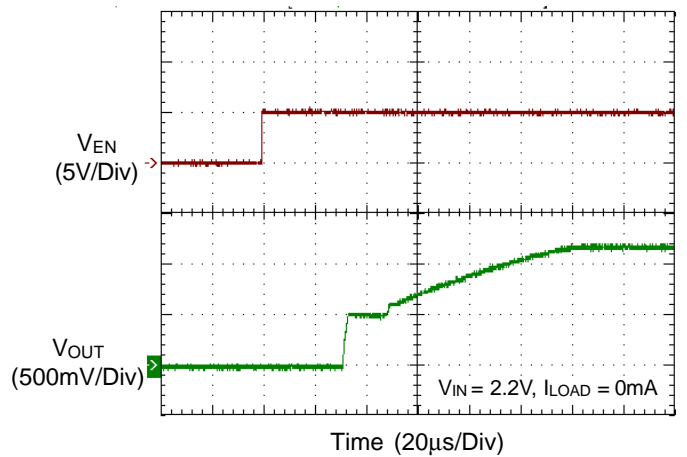

**Line Transient Response**

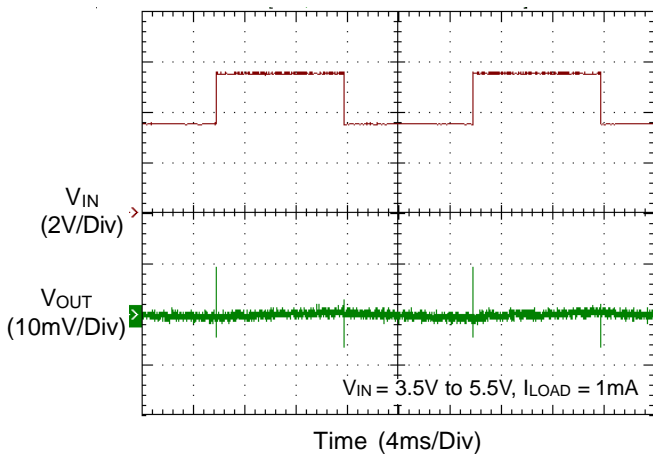

**Line Transient Response**

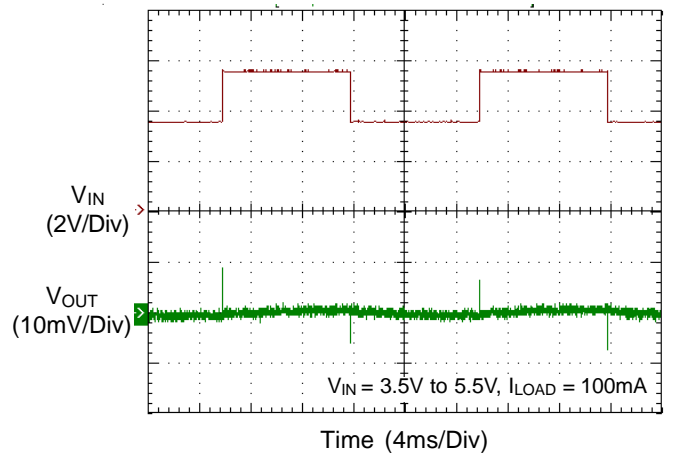

Load Transient Response

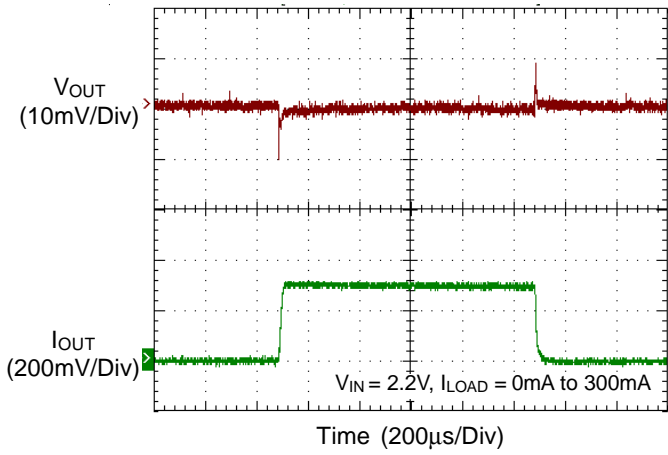

Load Transient Response

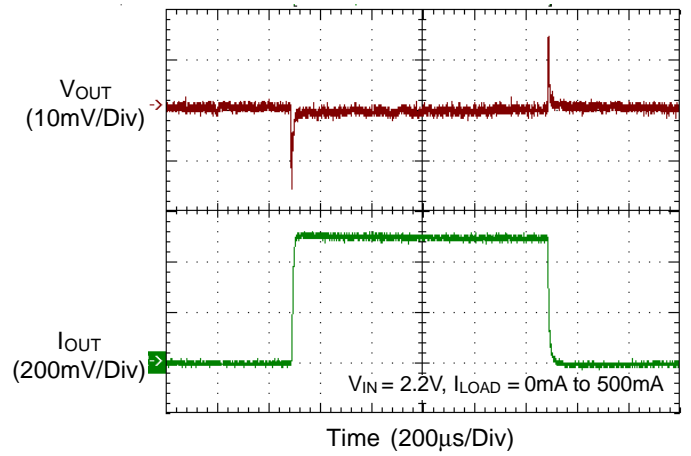

Noise

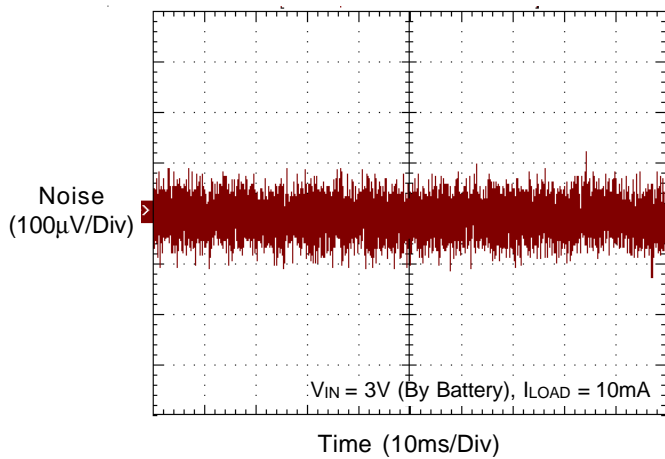

PSRR

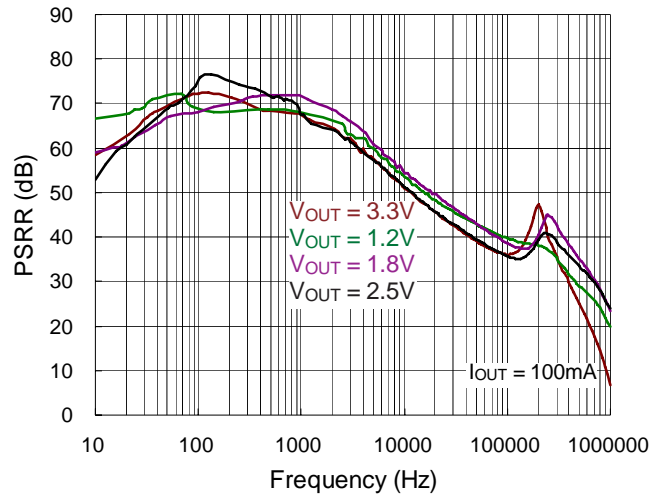

Dropout Voltage vs. Output Current

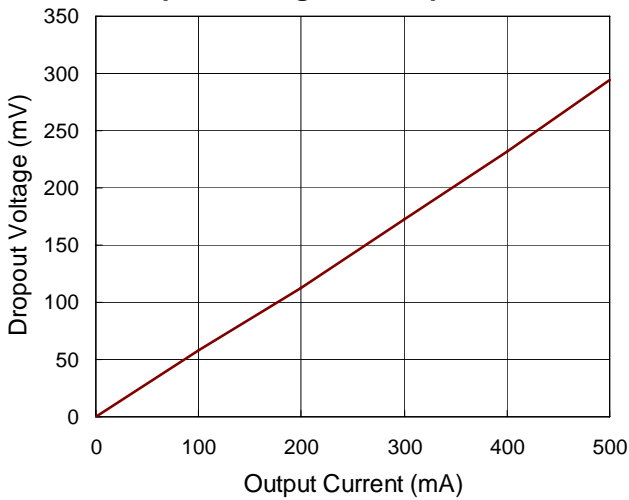



**Application Information**

The RT9065 requires input and output decoupling capacitors. These capacitors must be correctly selected for good performance and insufficient decoupling capacitance may cause oscillation.

**Input Capacitor**

The value of input capacitor should be  $\geq 2.2\mu\text{F}$ . The input capacitor must be placed within 1cm from the device to assure input stability. There are no requirements for the ESR (equivalent series resistance) on the input capacitor, but low-ESR ceramic capacitor with larger value provides better PSRR and line transient response.

**Output Capacitor**

The output capacitor must meet both requirements for minimum amount of capacitance and ESR for the LDO application. The RT9065 is designed specifically to work with low-ESR ceramic output capacitor in consideration of space-saving and performance. To ensure the stability, the value of ceramic capacitor should be at least  $1\mu\text{F}$  and ESR should be  $> 5\text{m}\Omega$ . The RT9065 can also work well with other types of output capacitors. Figure 1 shows the stable range of ESR as a function of load current for various output capacitor values. Output capacitor with larger capacitance can reduce noise and improve load transient response, stability, and PSRR. The output capacitor should be located no more than 0.5 inches from the VOUT pin.

**Region of Stable C<sub>OUT</sub> ESR vs. Output Current**

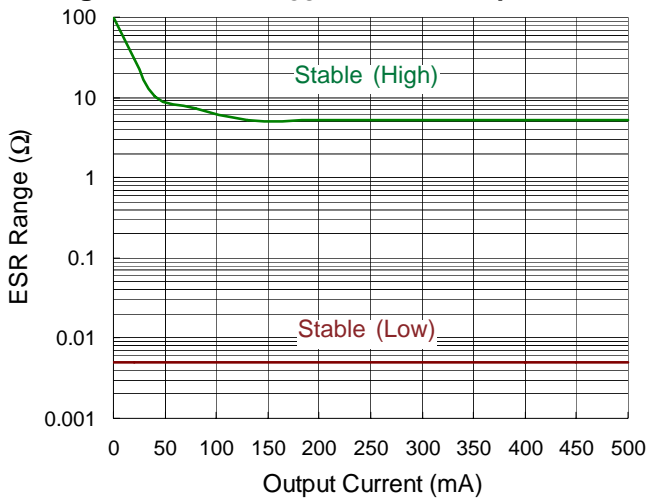

Figure 1. Region of Stable C<sub>OUT</sub> ESR

**Adjustable Output Voltage**

The output voltage is set by the ratio of two external resistors as follow :

$$V_{OUT} = 0.8 \times (1 + R1/R2)$$

**Bypass Capacitor and Low Noise**

Connecting a 22nF capacitor between the BP pin and the GND pin significantly reduces noise on the regulator output, and it is critical that the capacitor should be placed close to the IC and PCB traces should be as short as possible. DC leakage on this pin can affect the LDO regulator output noise and voltage regulation performance.

**Enable Function**

The RT9065 features an enable/disable function. The enable control level must be greater than 1.2V to turn-on the device. When the voltage on the EN pin falls below 0.4V, the LDO will be shut down and will reduce quiescent current to less than  $1\mu\text{A}$ . If the enable function is not needed in a specific application, it should be tied to VIN to keep the LDO in a continuously on state.

**Current Limit**

The RT9065 contains an independent current limiter, which monitors and controls the pass transistor's gate voltage, limiting the output current to 0.65A (typ.). The output can be shorted to ground without damaging the part.

**Thermal Considerations**

For continuous operation, do not exceed absolute maximum junction temperature. The maximum power dissipation depends on the thermal resistance of the IC package, PCB layout, rate of surrounding airflow, and difference between junction and ambient temperature. The maximum power dissipation can be calculated by the following formula :

$$P_{D(MAX)} = (T_{J(MAX)} - T_A) / \theta_{JA}$$

where  $T_{J(MAX)}$  is the maximum junction temperature,  $T_A$  is the ambient temperature, and  $\theta_{JA}$  is the junction to ambient thermal resistance.

For recommended operating condition specifications, the maximum junction temperature is 125°C. The junction to SOT-23-6 package, the thermal resistance,  $\theta_{JA}$ , is 208.2°C/W on a standard JEDEC 51-7 four-layer thermal test board. The maximum power dissipation at  $T_A = 25^\circ\text{C}$  can be calculated by the following formula :

$$P_{D(MAX)} = (125^\circ\text{C} - 25^\circ\text{C}) / (208.2^\circ\text{C}/\text{W}) = 0.48\text{W for SOT-23-6 package}$$

The maximum power dissipation depends on the operating ambient temperature for fixed  $T_{J(MAX)}$  and thermal resistance,  $\theta_{JA}$ . The derating curve in Figure 2 allows the designer to see the effect of rising ambient temperature on the maximum power dissipation.

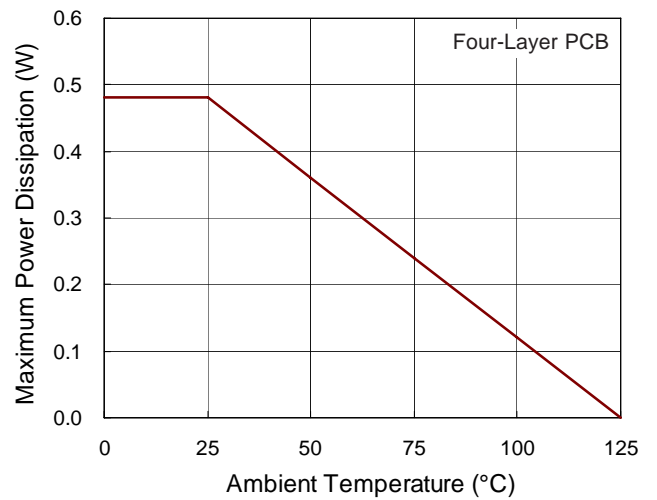
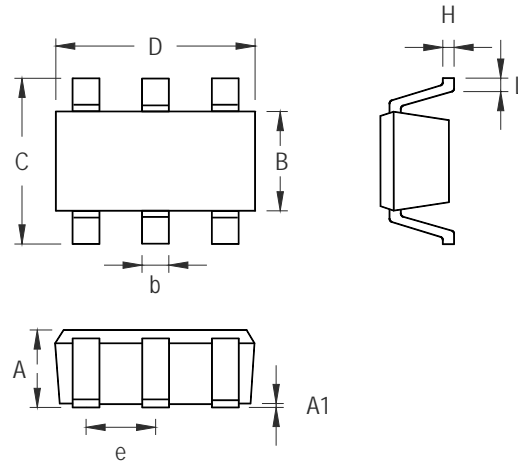

Figure 2. Derating Curve of Maximum Power Dissipation

**Outline Dimension**



Symbol	Dimensions In Millimeters		Dimensions In Inches	
	Min	Max	Min	Max
A	0.889	1.295	0.031	0.051
A1	0.000	0.152	0.000	0.006
B	1.397	1.803	0.055	0.071
b	0.250	0.560	0.010	0.022
C	2.591	2.997	0.102	0.118
D	2.692	3.099	0.106	0.122
e	0.838	1.041	0.033	0.041
H	0.080	0.254	0.003	0.010
L	0.300	0.610	0.012	0.024

**SOT-23-6 Surface Mount Package**

**Richtek Technology Corporation**

5F, No. 20, Taiyuen Street, Chupei City  
 Hsinchu, Taiwan, R.O.C.  
 Tel: (8863)5526789

Richtek products are sold by description only. Richtek reserves the right to change the circuitry and/or specifications without notice at any time. Customers should obtain the latest relevant information and data sheets before placing orders and should verify that such information is current and complete. Richtek cannot assume responsibility for use of any circuitry other than circuitry entirely embodied in a Richtek product. Information furnished by Richtek is believed to be accurate and reliable. However, no responsibility is assumed by Richtek or its subsidiaries for its use; nor for any infringements of patents or other rights of third parties which may result from its use. No license is granted by implication or otherwise under any patent or patent rights of Richtek or its subsidiaries.