

## 温补晶体振荡器TCX04. 500000MHZ

### Features

- voltage(3.3V~12.0V)
- Output Waveform(CMOS/TTL)
- Supports a WIDE FREQUENCY RANGE(4.500000MHZ)
- Versus Temperature Range:0.5ppm~1.5ppm
- Compact with dimensions of 20.8×13.2×8mm 12.8\*12.8\*7mm



### Specifications

项目Item	技术Specifications			备注Remarks
频率范围	4.500000MHZ			Fundamental AT-Cut
初始稳定度	≤±0.5PPM			
工作温度	-20℃ to 70℃	-40℃ to 85℃		
频率温度特性	≤±0.5PPM		≤±1.5PPM	
电源电压	3.3Vdc	5.0Vdc	12Vdc	±5%V
电源电流	≤30MA	≤50MA	≤80MA	
储存温度	-40℃ to 125℃			
老化率	第一年	10年		per Year
	≤1PPM	≤5PPM		
频率稳定性	±0.2PPM			Vcc±5%(25℃)
相位噪声(20M典型)	典型值			
	100Hz	-120 dBc/Hz		
	1KHz	-138 dBc/Hz		
	10Hz	-143 dBc/Hz		
	100KHz	-150 dBc/Hz		
	1MHz	-165 dBc/Hz		
起动时间	≤5MS			
输出特性	方波	正弦波		
	15PF, duty:50±3% VOH≥90VDD VOH≤0.1VDD	50 Ω VPP≥1V		
尺寸(MM)	12.8×12.8×7(DIP08)			
	20.8×13.2×8(DIP14)			
频率调节	机械调	电调(VC)		
	≥5PPM	≥8PPM		

## ■ Dimensions

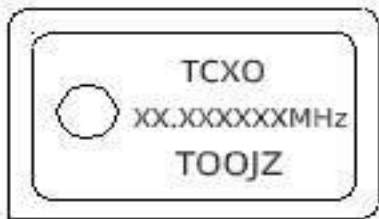
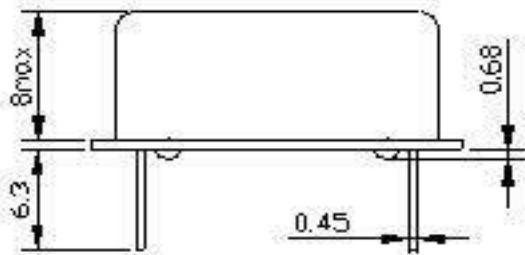
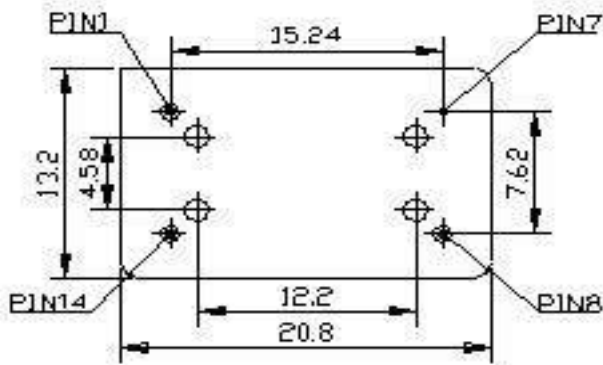

PIN	FUNCTION
1	Vcon/NC
7	GND
8	Output
14	Power Supply

## ■ Test Circuit

