

OPA455 High-Voltage (150-V), Wide-Bandwidth (6.5-MHz), High Output Current (45-mA), Unity-Gain Stable Op Amp

1 Features

- Wide power-supply range:
 - ± 6 V to ± 75 V
 - 12 V to 150 V
- High-output load drive: $I_O \pm 45$ mA
- Current limit protection
- Thermal protection
- Status flag
- Independent output disable
- Gain bandwidth: 6.5 MHz
- Slew rate: 32 V/ μ s
- Wide temperature range: -40°C to $+85^\circ\text{C}$
- 8-pin HSOIC (SO PowerPAD™) package

2 Applications

- [Semiconductor test](#)
- [Optical module](#)
- [Lab and field instrumentation](#)
- [Semiconductor manufacturing](#)
- [Multiparameter patient monitor](#)
- [Display panel for PC and notebooks](#)

3 Description

The OPA455 is a high-voltage (150-V), high current drive (45-mA), unity-gain stable operational amplifier with a gain-bandwidth product of 6.5 MHz and slew rate of 32 V/ μ s. As a result of the amplifier wide output range, this device is an excellent choice for high-voltage piezo driving, avalanche photodiode biasing, and high-voltage Howland current pump or voltage output stages.

The OPA455 is internally protected against overtemperature conditions and current overloads. The device is fully specified to perform over a wide power-supply range of ± 6 V to ± 75 V, or on a single supply of 12 V to 150 V. The status flag is an open-drain output that allows the device to be easily referenced to standard, low-voltage, logic circuitry. This high-voltage operational amplifier provides excellent accuracy and wide output swing, and is free from phase-inversion problems that are often found in similar amplifiers.

The output can be disabled using the enable-disable (E/D) pin. The E/D pin has a common return pin to allow for easy interface to low-voltage logic circuitry. This disable is accomplished without disturbing the input signal path, not only saving power but also protecting the load.

Device Information

PART NUMBER	PACKAGE ⁽¹⁾	BODY SIZE (NOM)
OPA455	HSOIC (8)	4.89 mm × 3.90 mm

- (1) For all available packages, see the package option addendum at the end of the data sheet.

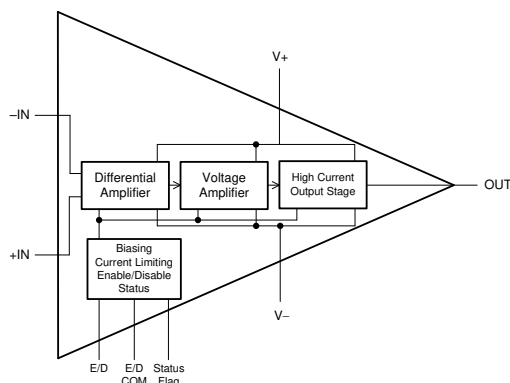

OPA455 Block Diagram

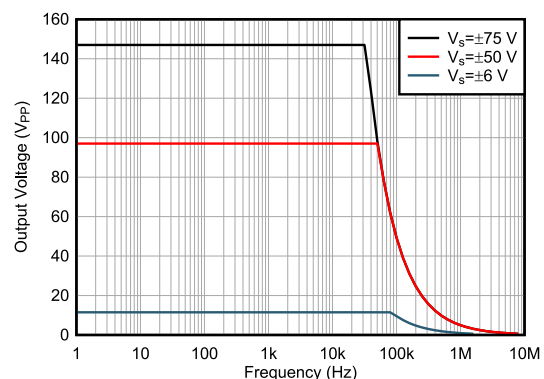

Maximum Output Voltage vs Frequency



Table of Contents

1 Features	1	8 Application and Implementation	21
2 Applications	1	8.1 Application Information.....	21
3 Description	1	8.2 Typical Applications.....	21
4 Revision History	2	9 Power Supply Recommendations	27
5 Pin Configuration and Functions	3	10 Layout	27
6 Specifications	4	10.1 Layout Guidelines.....	27
6.1 Absolute Maximum Ratings	4	10.2 Layout Example.....	30
6.2 ESD Ratings	4	11 Device and Documentation Support	31
6.3 Recommended Operating Conditions	4	11.1 Device Support.....	31
6.4 Thermal Information	4	11.2 Documentation Support.....	31
6.5 Electrical Characteristics	5	11.3 Support Resources.....	31
6.6 Typical Characteristics.....	7	11.4 Trademarks.....	32
7 Detailed Description	19	11.5 Electrostatic Discharge Caution.....	32
7.1 Overview.....	19	11.6 Glossary.....	32
7.2 Functional Block Diagram.....	19	12 Mechanical, Packaging, and Orderable Information	32
7.3 Feature Description.....	19		
7.4 Device Functional Modes.....	20		

4 Revision History

DATE	REVISION	NOTES
October 2020	*	Initial Release

5 Pin Configuration and Functions

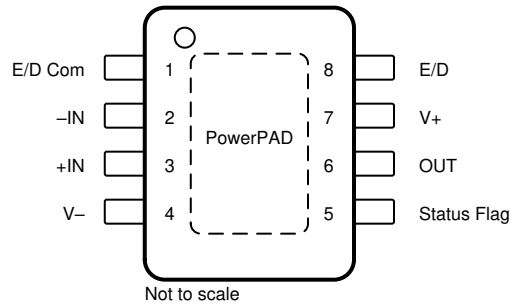

Figure 5-1. DDA (8-Pin, SO PowerPAD™) Package, Top View

Table 5-1. Pin Functions

PIN		I/O	DESCRIPTION
NAME	NO.		
E/D	8	I	Enable (active high) or disable (active low), with respect to E/D Com pin
E/D Com	1	I	Enable and disable common
-IN	2	I	Inverting input
+IN	3	I	Noninverting input
OUT	6	O	Output
Status Flag	5	O	Status Flag is an open-drain active-low output referenced to E/D Com. This pin goes active for either an overcurrent or overtemperature condition.
V-	4	—	Negative (lowest) power supply
V+	7	—	Positive (highest) power supply
PowerPAD	PowerPAD	—	The PowerPAD is internally connected to V-. The PowerPAD must be soldered to a printed-circuit board (PCB) connected to V-, even with applications that have low power dissipation.

6 Specifications

6.1 Absolute Maximum Ratings

over operating free-air temperature range (unless otherwise noted)⁽¹⁾

		MIN	MAX	UNIT
V _S	Supply voltage		160	V
+IN, -IN	Signal input pins ⁽²⁾	(V-) - 0.3	(V+) + 0.3	V
	E/D to E/D Com		7	V
	All input pins ⁽²⁾		±10	mA
	Output short circuit ⁽³⁾	Continuous	Continuous	
T _A	Operating	-55	125	°C
T _J	Junction		150	°C
T _{STG}	Storage	-55	125	°C

- (1) Stresses beyond those listed under *Absolute Maximum Ratings* may cause permanent damage to the device. These are stress ratings only, which do not imply functional operation of the device at these or any other conditions beyond those indicated under [Section 6.3](#). Exposure to absolute-maximum-rated conditions for extended periods may affect device reliability.
- (2) Input terminals, Status Flag, E/D, and E/D Com, and Output are diode-clamped to the power-supply rails. Input signals that can swing more than 0.3 V beyond the supply rails must be current-limited to 10 mA or less.
- (3) Short-circuit to ground.

6.2 ESD Ratings

			VALUE	UNIT
V _(ESD)	Electrostatic discharge	Human-body model (HBM), per ANSI/ESDA/JEDEC JS-001 ⁽¹⁾	±3000	V
		Charged-device model (CDM), per JEDEC specification JESD22-C101 ⁽²⁾	±250	

- (1) JEDEC document JEP155 states that 500-V HBM allows safe manufacturing with a standard ESD control process.
- (2) JEDEC document JEP157 states that 250-V CDM allows safe manufacturing with a standard ESD control process.

6.3 Recommended Operating Conditions

over operating free-air temperature range (unless otherwise noted)

		MIN	NOM	MAX	UNIT
V _S	Supply voltage	±6		±75	V
T _A	Specified temperature	-40		85	°C

6.4 Thermal Information

THERMAL METRIC ⁽¹⁾		OPA455	UNIT
		DDA (HSOIC)	
		8 PINS	
R _{θJA}	Junction-to-ambient thermal resistance	36.7	°C/W
R _{θJC(top)}	Junction-to-case (top) thermal resistance	45.4	°C/W
R _{θJB}	Junction-to-board thermal resistance	11.3	°C/W
ψ _{JT}	Junction-to-top characterization parameter	1.8	°C/W
ψ _{JB}	Junction-to-board characterization parameter	11.3	°C/W
R _{θJC(bot)}	Junction-to-case (bottom) thermal resistance	2.1	°C/W

- (1) For more information about traditional and new thermal metrics, see the [Semiconductor and IC Package Thermal Metrics](#) application report.

6.5 Electrical Characteristics

at $T_A = 25^\circ\text{C}$, $V_S = \pm 75\text{V}$, $R_L = 10\text{ k}\Omega$ to mid-supply, $V_{CM} = V_{OUT} = \text{mid-supply}$ (unless otherwise noted)

PARAMETER		TEST CONDITIONS	MIN	TYP	MAX	UNIT
OFFSET VOLTAGE						
V_{OS}	Input offset voltage	$I_O = 0\text{ mA}$		± 0.2	± 3.4	mV
dV_{OS}/dT	Input offset voltage drift	$T_A = -40^\circ\text{C}$ to $+85^\circ\text{C}$		± 4	± 20	$\mu\text{V}/^\circ\text{C}$
$PSRR$	Power supply rejection ratio	$V_S = \pm 6\text{ V}$ to $\pm 75\text{ V}$		0.03	0.3	$\mu\text{V}/\text{V}$
		$V_S = \pm 6\text{ V}$ to $\pm 75\text{ V}$, $T_A = -40^\circ\text{C}$ to $+85^\circ\text{C}$		0.3	1.5	
INPUT BIAS CURRENT						
I_B	Input bias current	$V_S = \pm 50\text{ V}$		± 30	± 100	pA
		$T_A = -40^\circ\text{C}$ to $+85^\circ\text{C}$			± 1.8	nA
I_{OS}	Input offset current			± 30	± 100	pA
		$T_A = -40^\circ\text{C}$ to $+85^\circ\text{C}$			± 1	nA
NOISE						
e_n	Input voltage noise density	$f = 1\text{ kHz}$		33		$\text{nV}/\sqrt{\text{Hz}}$
		$f = 10\text{ kHz}$		23		
	Input voltage noise	$f = 0.1\text{ Hz}$ to 10 Hz		12		μV_{PP}
i_n	Current noise density	$f = 1\text{ kHz}$		40		$\text{fA}/\sqrt{\text{Hz}}$
		$f = 10\text{ kHz}$		450		
INPUT VOLTAGE						
V_{CM}	Common-mode voltage	Linear operation	$(V-) + 1$		$(V+) - 3$	V
$CMRR$	Common-mode rejection	$-75\text{ V} \leq V_{CM} \leq 75\text{ V}$	120	128		dB
		$-75\text{ V} \leq V_{CM} \leq 75\text{ V}$, $T_A = -40^\circ\text{C}$ to $+85^\circ\text{C}$	120	128		
INPUT IMPEDANCE						
	Differential			$10^{13} \parallel 6$		$\Omega \parallel \text{pF}$
	Common-mode			$10^{13} \parallel 3.5$		$\Omega \parallel \text{pF}$
OPEN-LOOP GAIN						
A_{OL}	Open-loop voltage gain	$(V-) + 3\text{ V} < V_O < (V+) - 3\text{ V}$	126	135		dB
		$(V-) + 3\text{ V} < V_O < (V+) - 3\text{ V}$, $T_A = -40^\circ\text{C}$ to $+85^\circ\text{C}$	120	134		
		$(V-) + 5\text{ V} < V_O < (V+) - 5\text{ V}$, $R_L = 5\text{ k}\Omega$	126	135		
		$(V-) + 5\text{ V} < V_O < (V+) - 5\text{ V}$, $R_L = 5\text{ k}\Omega$, $T_A = -40^\circ\text{C}$ to $+85^\circ\text{C}$	120	130		
FREQUENCY RESPONSE						
GBW	Gain-bandwidth product	Small-signal		6.5		MHz
SR	Slew rate	$G = \pm 1\text{ V/V}$, $V_O = 80\text{-V}$ step, $R_L = 3.27\text{ k}\Omega$		32		$\text{V}/\mu\text{s}$
	Full-power bandwidth			33		kHz
t_s	Settling time	To $\pm 0.01\%$, $G = \pm 5\text{ V/V}$ or $\pm 10\text{ V/V}$, $V_O = 120\text{-V}$ step		5.2		μs

6.5 Electrical Characteristics (continued)

at $T_A = 25^\circ\text{C}$, $V_S = \pm 75\text{V}$, $R_L = 10\text{ k}\Omega$ to mid-supply, $V_{CM} = V_{OUT} = \text{mid-supply}$ (unless otherwise noted)

PARAMETER		TEST CONDITIONS	MIN	TYP	MAX	UNIT
THD+N	Total harmonic distortion + noise	$G = +10\text{ V/V}$, $f = 1\text{ kHz}$, $V_O = 140\text{ V}_{PP}$		0.0009		%
		$G = +10\text{ V/V}$, $f = 1\text{ kHz}$, $V_O = 140\text{ V}_{PP}$, $R_L = 5\text{ k}\Omega$		0.0012		
		$G = +20\text{ V/V}$, $f = 1\text{ kHz}$, $V_O = 140\text{ V}_{PP}$		0.0015		
		$G = +20\text{ V/V}$, $f = 1\text{ kHz}$, $V_O = 140\text{ V}_{PP}$, $R_L = 5\text{ k}\Omega$		0.0025		
OUTPUT						
	Overload recovery	$G = -10\text{ V/V}$		140		ns
V_O	Output voltage swing	$R_L = 10\text{ k}\Omega$	$(V-) + 3$		$(V+) - 1.5$	V
		$R_L = 5\text{ k}\Omega$	$(V-) + 5$		$(V+) - 3$	
I_{SC}	Short-circuit current	$V_S = \pm 45\text{ V}$, $T_A = -40^\circ\text{C}$ to $+85^\circ\text{C}$		± 45		mA
C_{LOAD}	Capacitive load drive			200		pF
Z_O	Open-loop output impedance	$f = 1\text{ MHz}$		90		Ω
	Output impedance	Output disabled		160		k Ω
	Output capacitance	Output disabled		36		pF
STATUS FLAG PIN (Referenced to E/D Com)						
	Status Flag delay	Enable \rightarrow Disable, 10-k Ω pullup to 5 V		3.5		μs
		Disable \rightarrow Enable, 10-k Ω pullup to 5 V		11		
		Overcurrent delay, 10-k Ω pullup to 5 V		1		
		Overcurrent recovery delay, 10-k Ω pullup to 5 V		9		
Device thermal shutdown	Alarm (Status Flag high)			150		$^\circ\text{C}$
	Return to normal operation (Status Flag low)			130		
	Status Flag output voltage	Normal operation		See typical curves		V
E/D (ENABLE/DISABLE) PIN						
V_{SD}	High (output enabled)	Pin open or forced high	E/D Com + 0.8		E/D Com + 5.5	V
	Low (output disabled)	Pin forced low	E/D Com		E/D Com + 0.35	
	Output disable time			4		μs
	Output enable time			2.5		μs
E/D COM PIN						
	Pin voltage	$V_S \geq 106\text{ V}$	$(V-)$		$(V-) + 100$	V
		$V_S < 106\text{ V}$	$(V-)$		$(V+) - 6$	
POWER SUPPLY						
I_Q	Quiescent current	$I_O = 0\text{ mA}$		3.2	3.7	mA
	Quiescent current in Shutdown mode	$I_O = 0\text{ mA}$, $V_{E/D} = 0.65\text{ V}$		1.5	2	mA

6.6 Typical Characteristics

at $T_A = 25^\circ\text{C}$, $V_S = \pm 75\text{ V}$, and $R_L = 10\text{ k}\Omega$ connected to GND, output enabled (unless otherwise noted)

Table 6-1. Table of Graphs

DESCRIPTION	FIGURE
Offset Voltage Distribution at 25°C	Figure 6-1
Offset Voltage Distribution at 85°C	Figure 6-2
Offset Voltage Distribution at -40°C	Figure 6-3
Offset Voltage Drift Distribution from -40°C to $+85^\circ\text{C}$	Figure 6-4
Offset Voltage vs Temperature	Figure 6-5
Offset Voltage Warmup	Figure 6-6
Offset Voltage vs Common-Mode Voltage (Low V_{cm})	Figure 6-7
Offset Voltage vs Common-Mode Voltage (High V_{cm})	Figure 6-8
Offset Voltage vs Power Supply (Low Supply)	Figure 6-9
Offset Voltage vs Power Supply (High Supply)	Figure 6-10
Offset Voltage vs Output Voltage (Low Output)	Figure 6-11
Offset Voltage vs Output Voltage (High Output)	Figure 6-12
CMRR vs Temperature	Figure 6-13
CMRR vs Frequency	Figure 6-14
PSRR vs Temperature	Figure 6-15
PSRR vs Frequency	Figure 6-16
EMIRR vs Frequency	Figure 6-17
No Phase Reversal	Figure 6-18
Input Bias Current Production Distribution at 25°C	Figure 6-19
IB vs Temperature	Figure 6-20
IB vs Common-Mode Voltage	Figure 6-21
Enable Response	Figure 6-22
Current Limit Response	Figure 6-23
Open-Loop Gain vs Temperature	Figure 6-24
Open-Loop Gain vs Output Voltage	Figure 6-25
Open-Loop Gain and Phase vs Frequency	Figure 6-26
Open-Loop Output Impedance vs Frequency	Figure 6-27
Closed-Loop Gain vs Frequency	Figure 6-28
Maximum Output Voltage vs Frequency	Figure 6-29
Positive Output Voltage vs Output Current	Figure 6-30
Negative Output Voltage vs Output Current	Figure 6-31
Short-Circuit Current vs Temperature	Figure 6-32
Negative Overload Recovery	Figure 6-33
Positive Overload Recovery	Figure 6-34
Settling Time	Figure 6-35
Phase Margin vs Capacitive Load	Figure 6-36
Small-Signal Overshoot vs Capacitive Load ($G = -1$)	Figure 6-37
Small-Signal Overshoot vs Capacitive Load ($G = +1$)	Figure 6-38
Small-Signal Step Response ($G = -1$)	Figure 6-39
Small-Signal Step Response ($G = +1$)	Figure 6-40
Large-Signal Step Response ($G = -1$)	Figure 6-41
Large-Signal Step Response ($G = +1$)	Figure 6-42

6.6 Typical Characteristics

at $T_A = 25^\circ\text{C}$, $V_S = \pm 75\text{ V}$, and $R_L = 10\text{ k}\Omega$ connected to GND, output enabled (unless otherwise noted)

Table 6-1. Table of Graphs (continued)

DESCRIPTION	FIGURE
Slew Rate vs Output Step Size	Figure 6-43
Slew Rate vs Supply Voltage (Inverting)	Figure 6-44
Slew Rate vs Supply Voltage (Noninverting)	Figure 6-45
THD+N Ratio vs Frequency (G = 10)	Figure 6-46
THD+N Ratio vs Frequency (G = 20)	Figure 6-47
THD+N Ratio vs Output Amplitude (G = 10)	Figure 6-48
THD+N Ratio vs Output Amplitude (G = 20)	Figure 6-49
0.1-Hz to 10-Hz Noise	Figure 6-50
Input Voltage Noise Spectral Density	Figure 6-51
Current Noise Density	Figure 6-52
Quiescent Current Production Distribution at 25°C	Figure 6-53
Quiescent Current vs Supply Voltage	Figure 6-54
Quiescent Current vs Temperature	Figure 6-55
Status Flag Voltage vs Temperature	Figure 6-56
Quiescent Current vs Enable Voltage	Figure 6-57
Enable Current vs Enable Voltage	Figure 6-58
Status Flag Current vs Voltage	Figure 6-59

6.6 Typical Characteristics

at $T_A = 25^\circ\text{C}$, $V_S = \pm 75\text{ V}$, and $R_L = 10\text{ k}\Omega$ connected to GND, output enabled (unless otherwise noted)

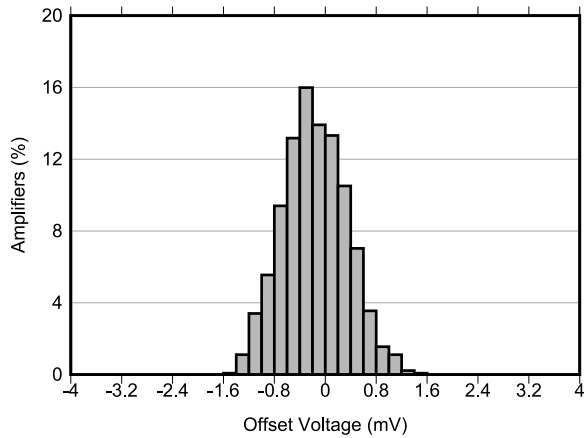

Figure 6-1. Offset Voltage Distribution at 25°C

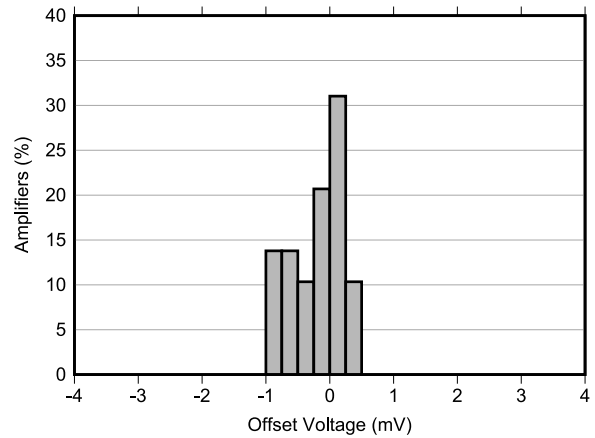

Figure 6-2. Offset Voltage Distribution at 85°C

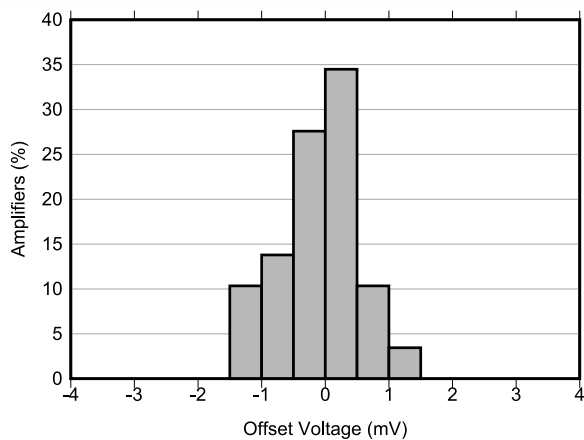

Figure 6-3. Offset Voltage Distribution at -40°C

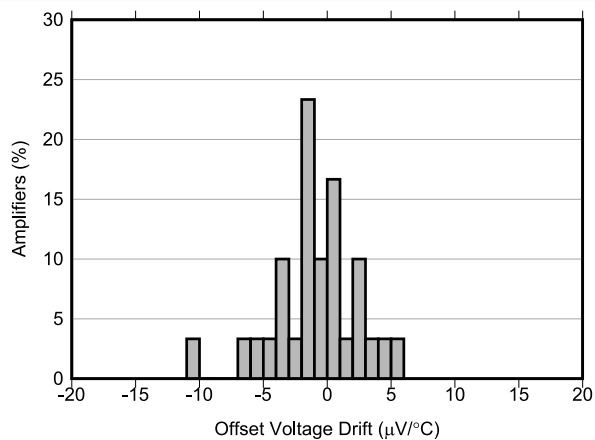

Figure 6-4. Offset Voltage Drift Distribution From -40°C to +85°C

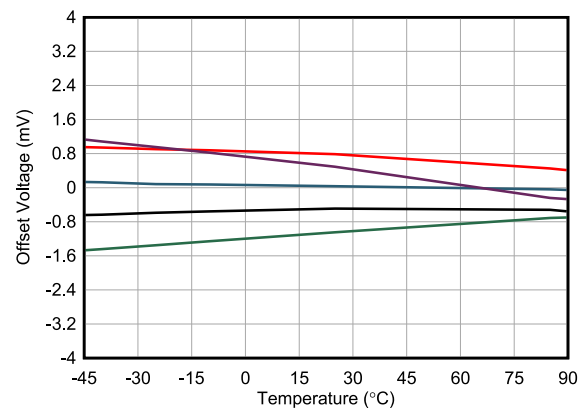

Figure 6-5. Offset Voltage vs Temperature

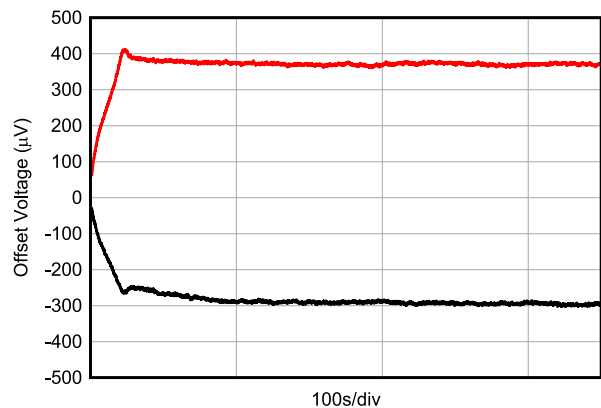

Figure 6-6. Offset Voltage Warmup

6.6 Typical Characteristics (continued)

at $T_A = 25^\circ\text{C}$, $V_S = \pm 75\text{ V}$, and $R_L = 10\text{ k}\Omega$ connected to GND, output enabled (unless otherwise noted)

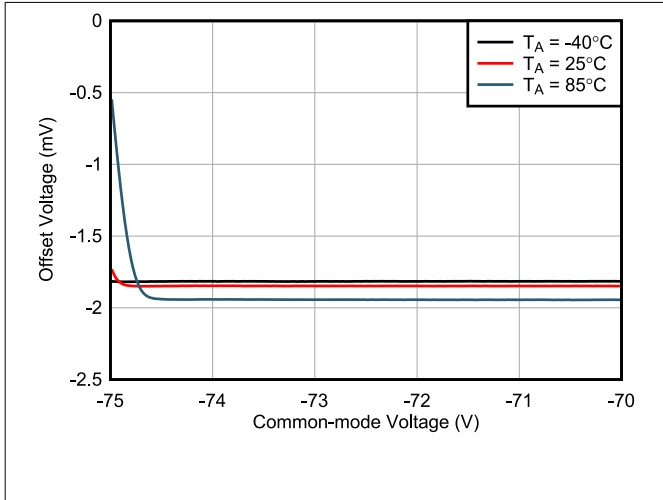

Figure 6-7. Offset Voltage vs Common-Mode Voltage (Low V_{CM})

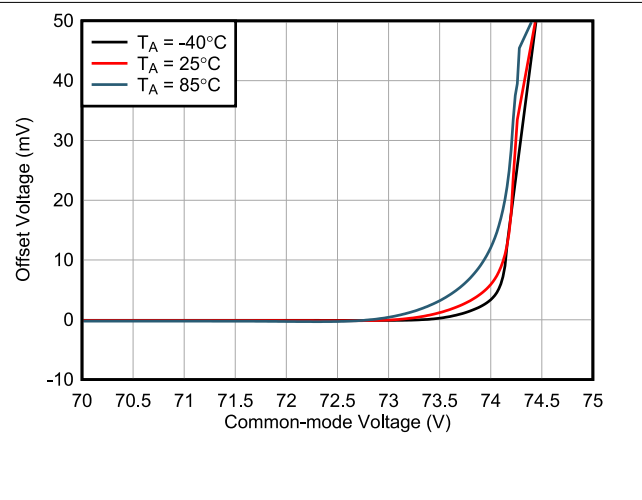

Figure 6-8. Offset Voltage vs Common-Mode Voltage (High V_{CM})

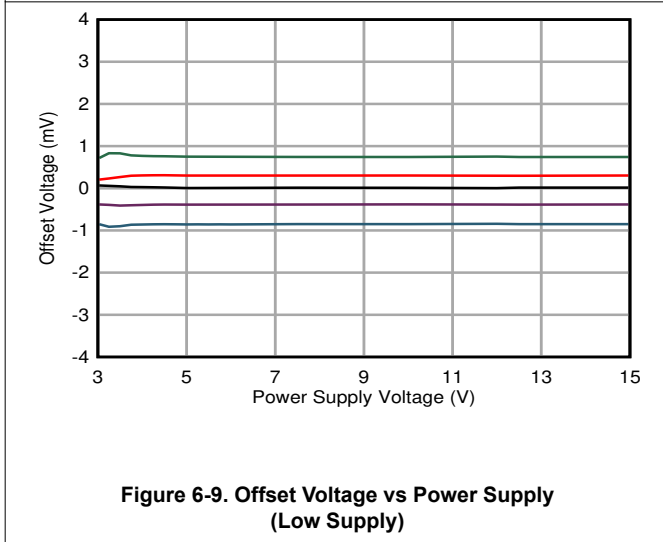

Figure 6-9. Offset Voltage vs Power Supply (Low Supply)

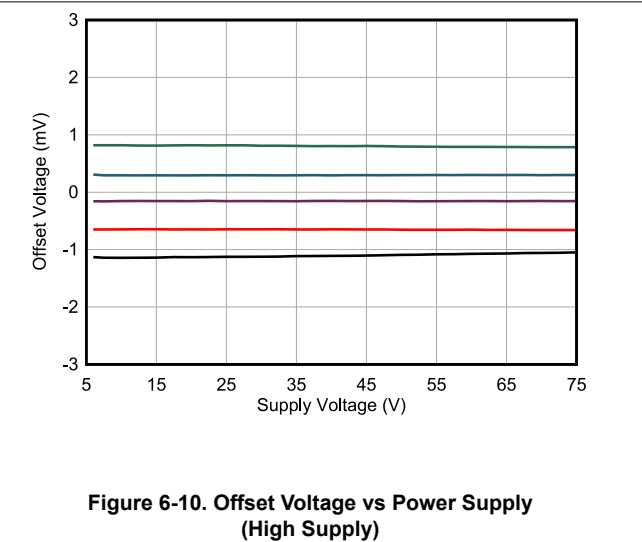

Figure 6-10. Offset Voltage vs Power Supply (High Supply)

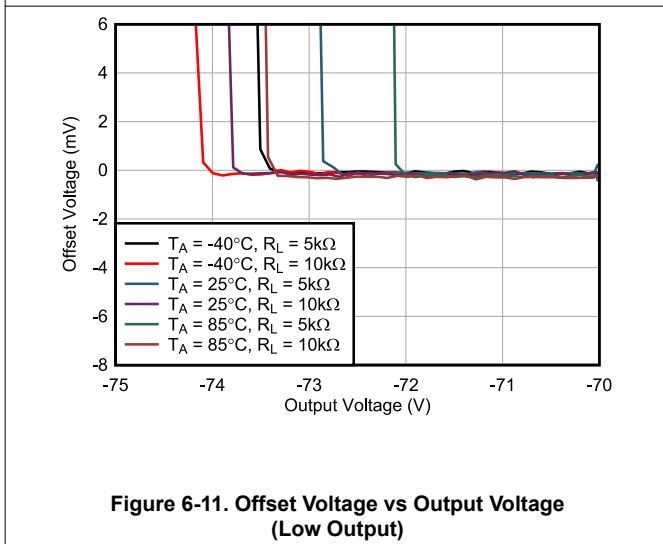

Figure 6-11. Offset Voltage vs Output Voltage (Low Output)

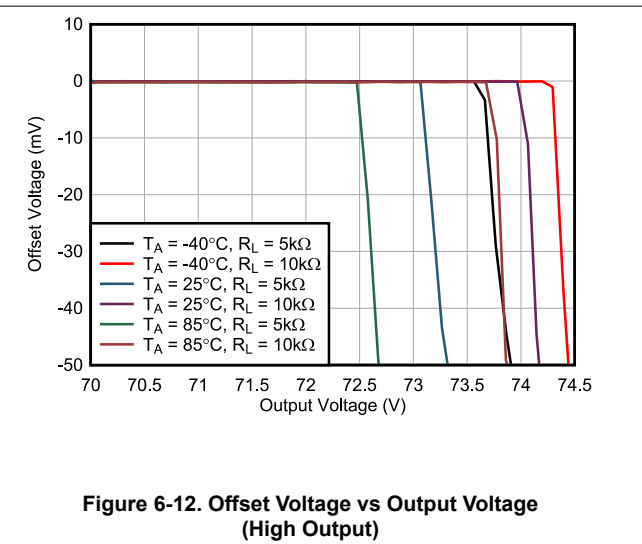

Figure 6-12. Offset Voltage vs Output Voltage (High Output)

6.6 Typical Characteristics (continued)

at $T_A = 25^\circ\text{C}$, $V_S = \pm 75\text{ V}$, and $R_L = 10\text{ k}\Omega$ connected to GND, output enabled (unless otherwise noted)

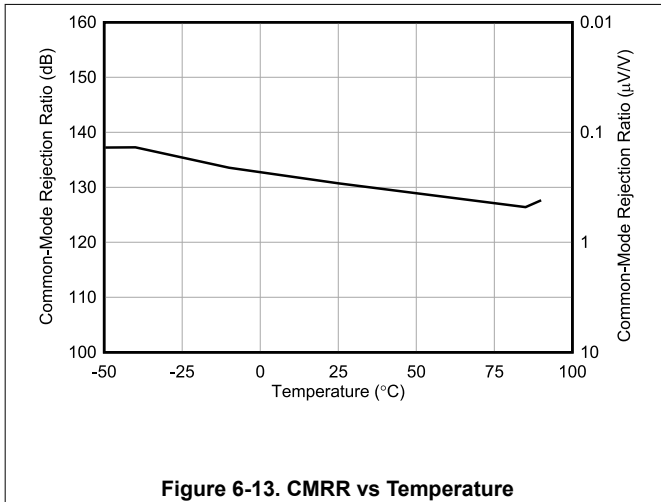

Figure 6-13. CMRR vs Temperature

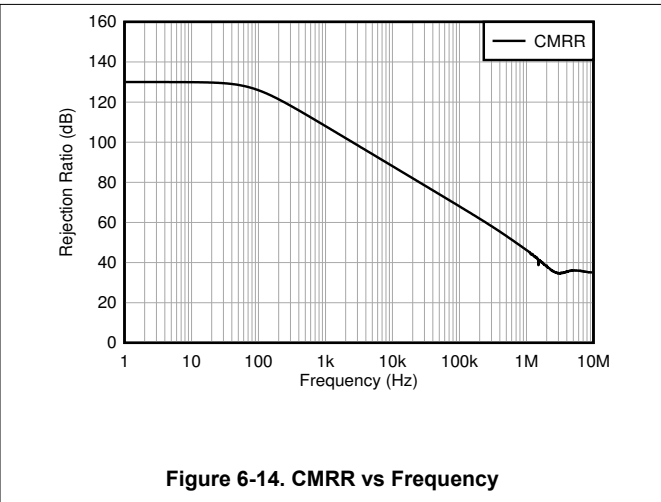

Figure 6-14. CMRR vs Frequency

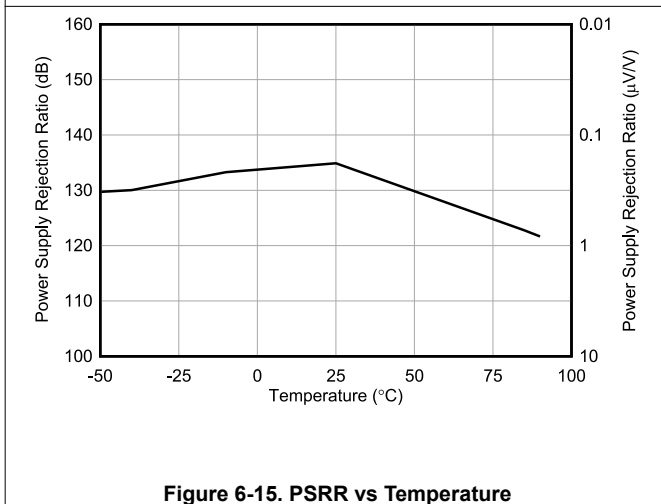

Figure 6-15. PSRR vs Temperature

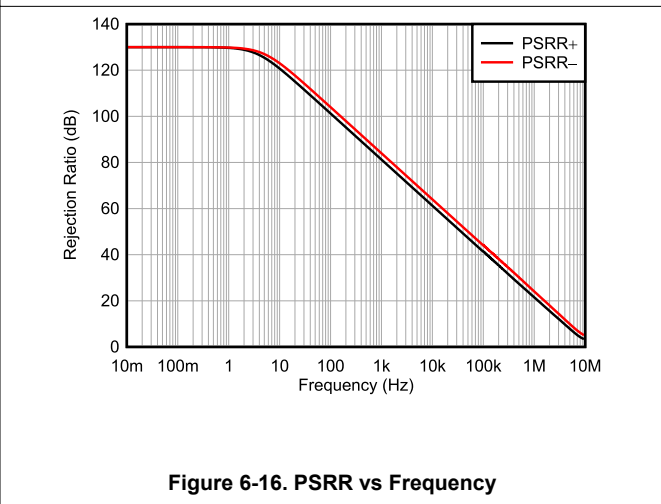

Figure 6-16. PSRR vs Frequency

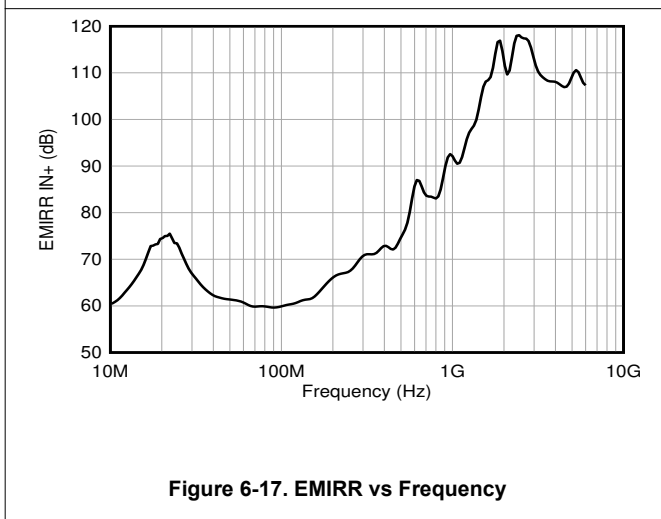

Figure 6-17. EMIRR vs Frequency

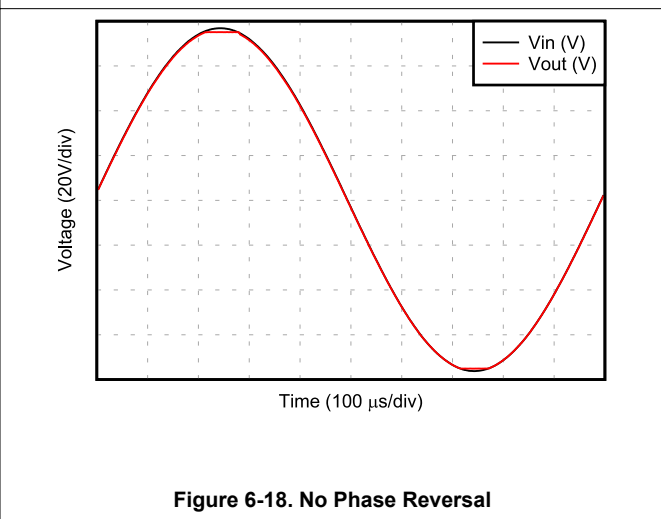

Figure 6-18. No Phase Reversal

6.6 Typical Characteristics (continued)

at $T_A = 25^\circ\text{C}$, $V_S = \pm 75\text{ V}$, and $R_L = 10\text{ k}\Omega$ connected to GND, output enabled (unless otherwise noted)

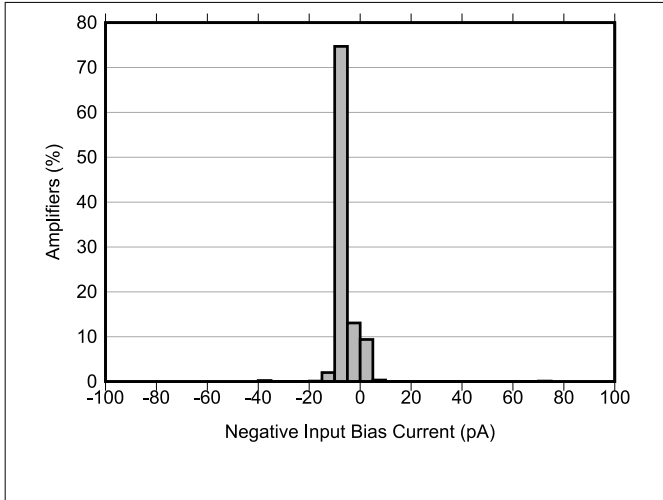

Figure 6-19. Input Bias Current Production Distribution at 25°C

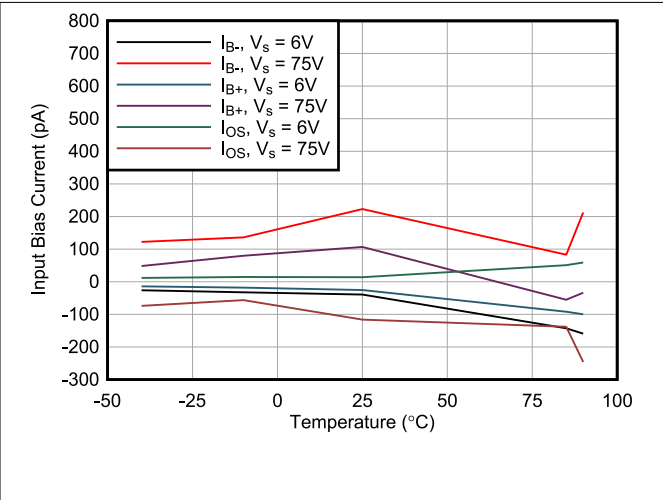

Figure 6-20. IB vs Temperature

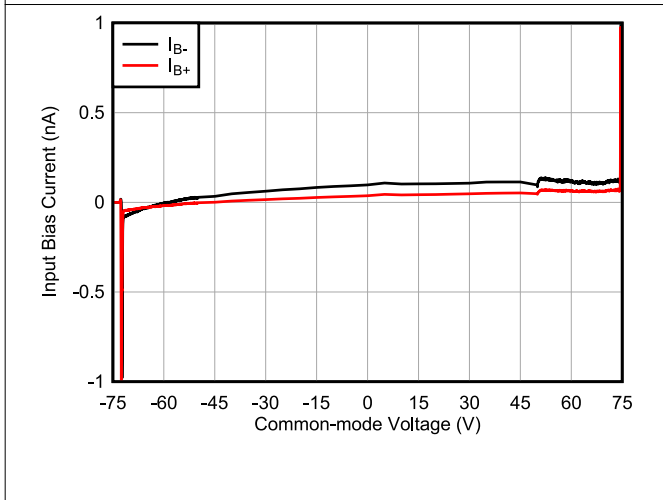

Figure 6-21. IB vs Common-Mode Voltage

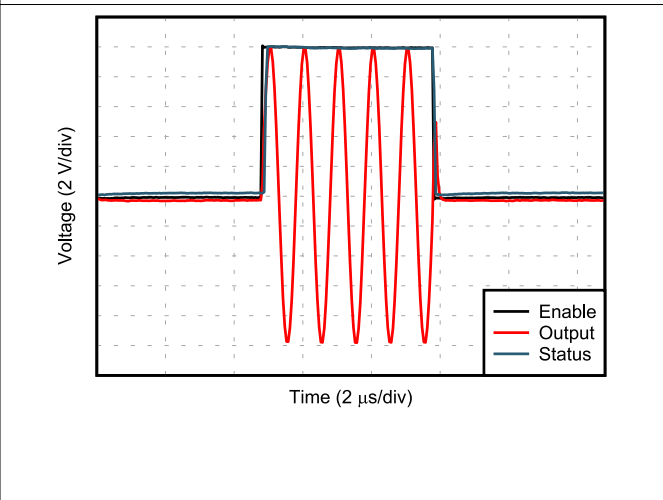

Figure 6-22. Enable Response

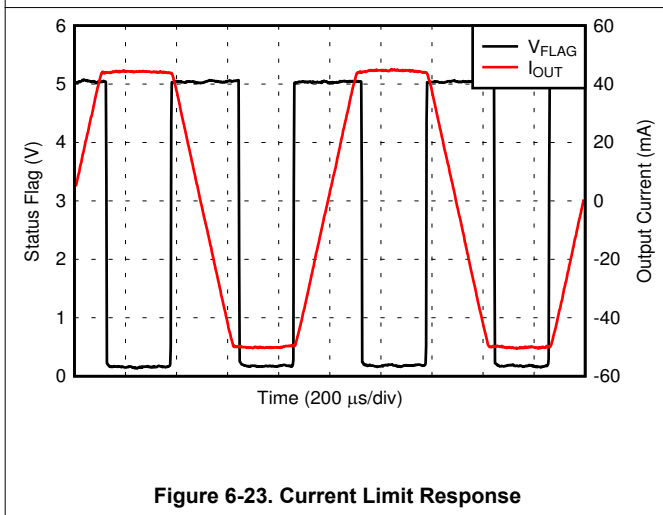

Figure 6-23. Current Limit Response

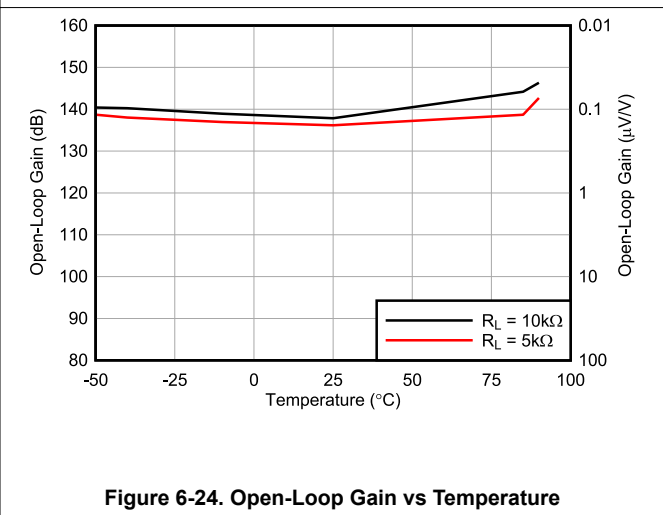

Figure 6-24. Open-Loop Gain vs Temperature

6.6 Typical Characteristics (continued)

at $T_A = 25^\circ\text{C}$, $V_S = \pm 75\text{ V}$, and $R_L = 10\text{ k}\Omega$ connected to GND, output enabled (unless otherwise noted)

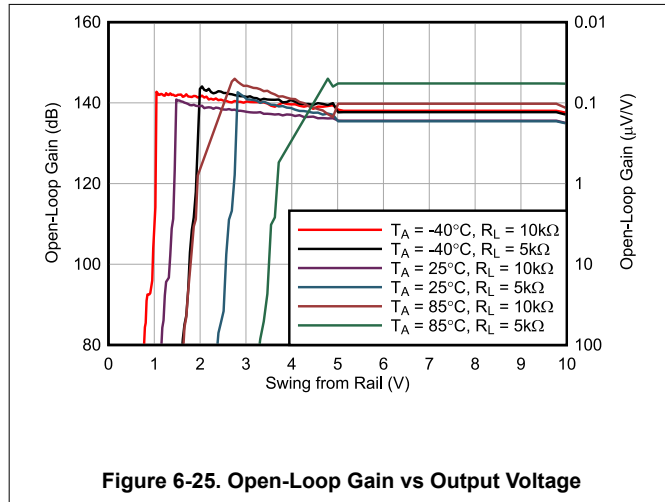

Figure 6-25. Open-Loop Gain vs Output Voltage

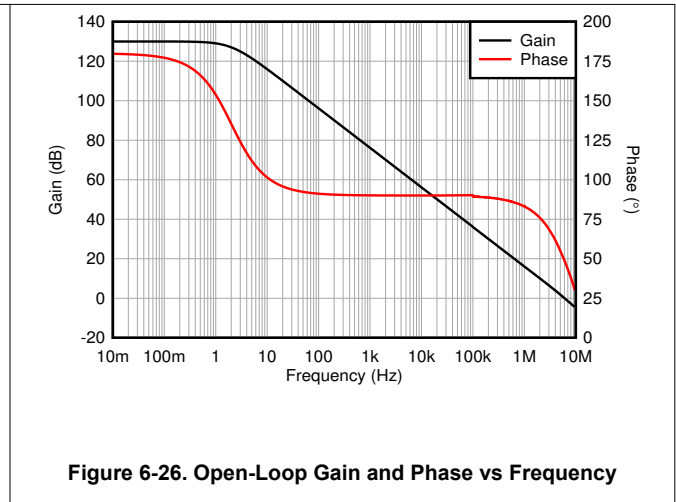

Figure 6-26. Open-Loop Gain and Phase vs Frequency

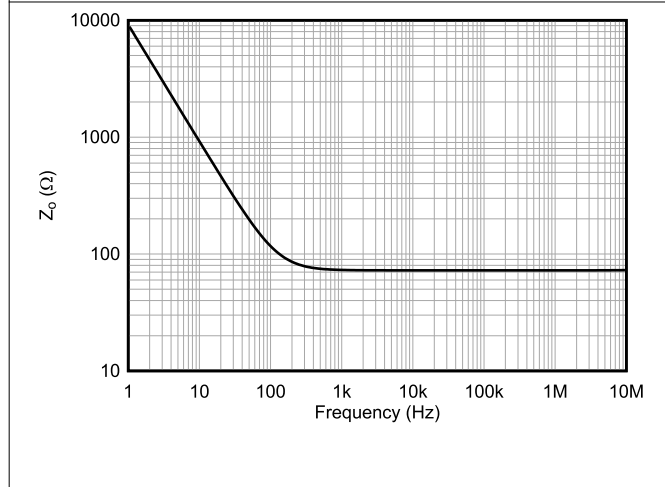

Figure 6-27. Open-Loop Output Impedance vs Frequency

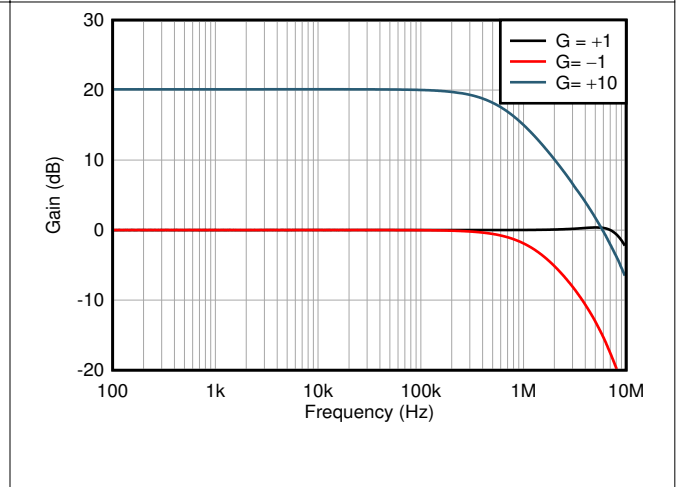

Figure 6-28. Closed-Loop Gain vs Frequency

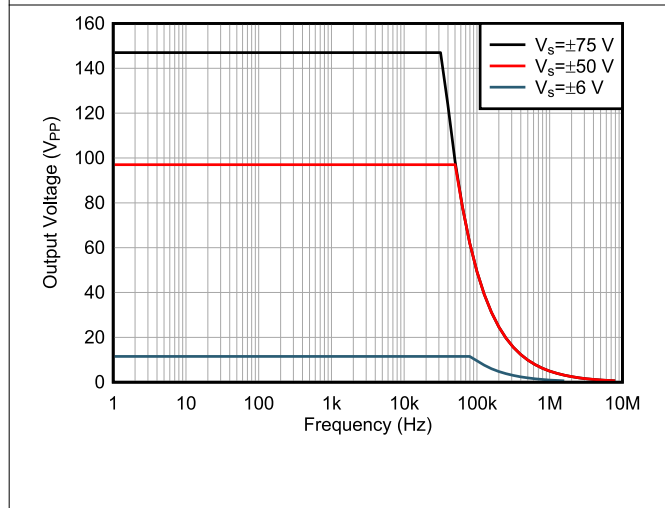

Figure 6-29. Maximum Output Voltage vs Frequency

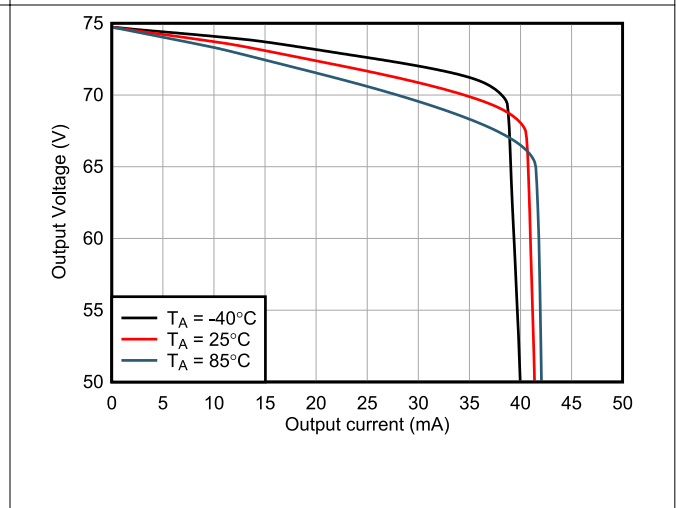

Figure 6-30. Positive Output Voltage vs Output Current

6.6 Typical Characteristics (continued)

at $T_A = 25^\circ\text{C}$, $V_S = \pm 75\text{ V}$, and $R_L = 10\text{ k}\Omega$ connected to GND, output enabled (unless otherwise noted)

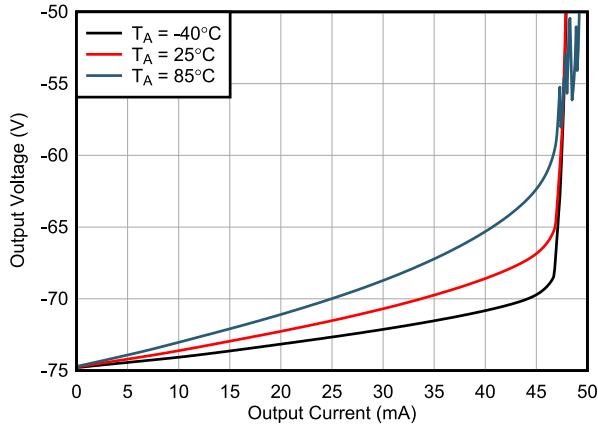

Figure 6-31. Negative Output Voltage vs Output Current

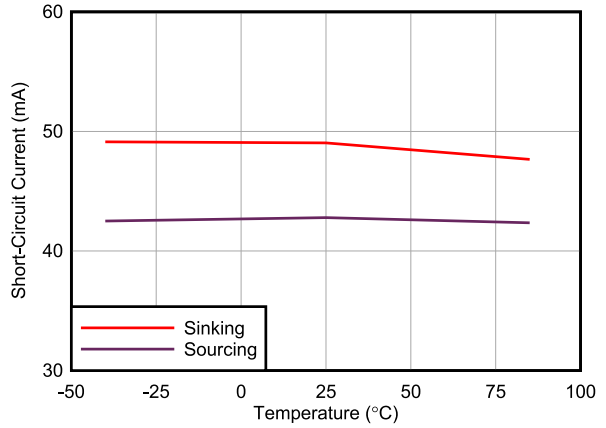

Figure 6-32. Short-Circuit Current vs Temperature

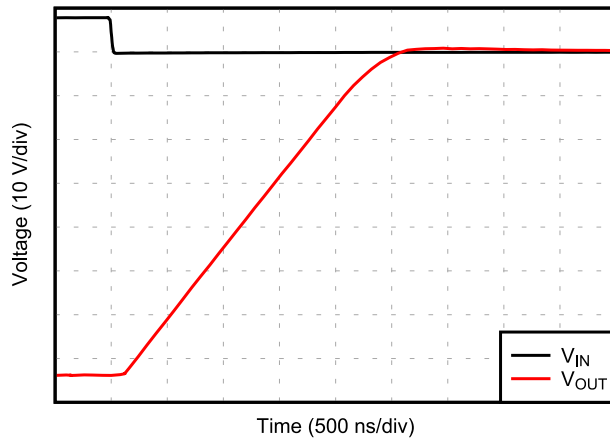

Figure 6-33. Negative Overload Recovery

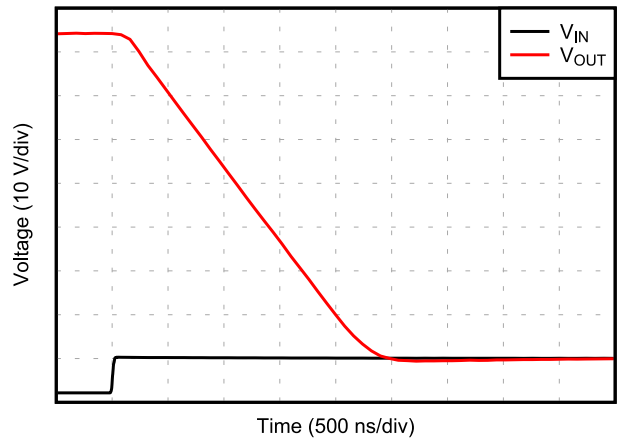

Figure 6-34. Positive Overload Recovery

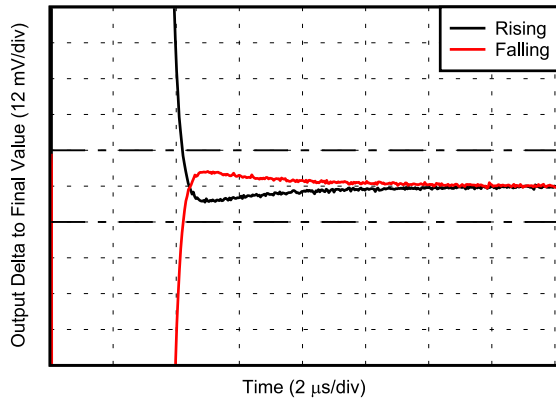

Figure 6-35. Settling Time

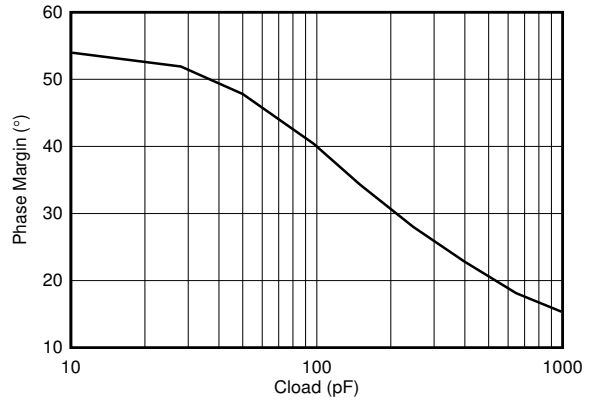

Figure 6-36. Phase Margin vs Capacitive Load

6.6 Typical Characteristics (continued)

at $T_A = 25^\circ\text{C}$, $V_S = \pm 75\text{ V}$, and $R_L = 10\text{ k}\Omega$ connected to GND, output enabled (unless otherwise noted)

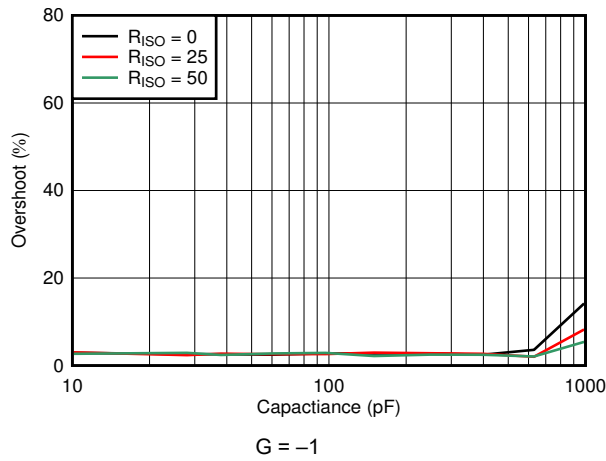

Figure 6-37. Small-Signal Overshoot vs Capacitive Load

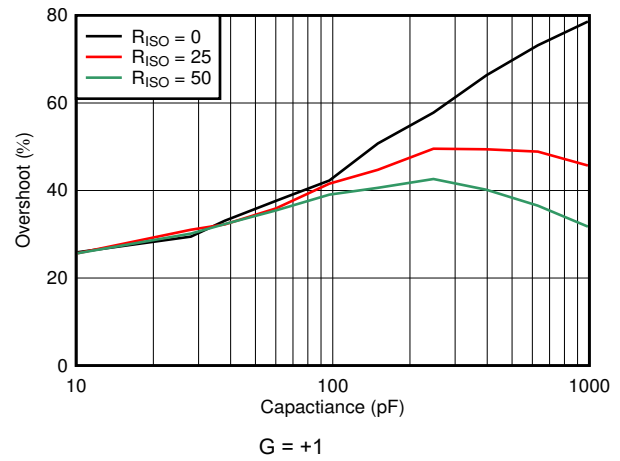

Figure 6-38. Small-Signal Overshoot vs Capacitive Load

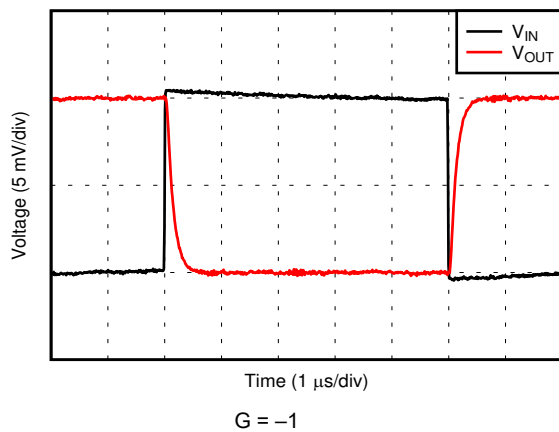

Figure 6-39. Small-Signal Step Response

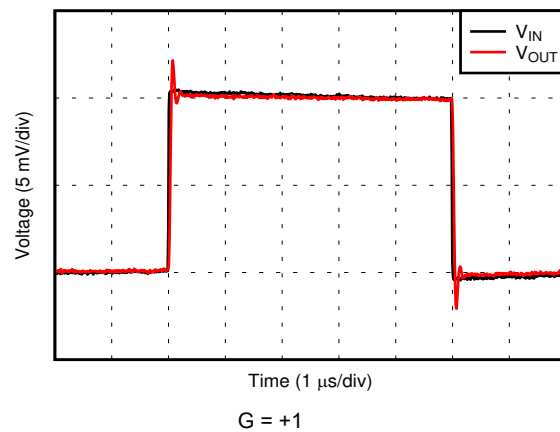

Figure 6-40. Small-Signal Step Response

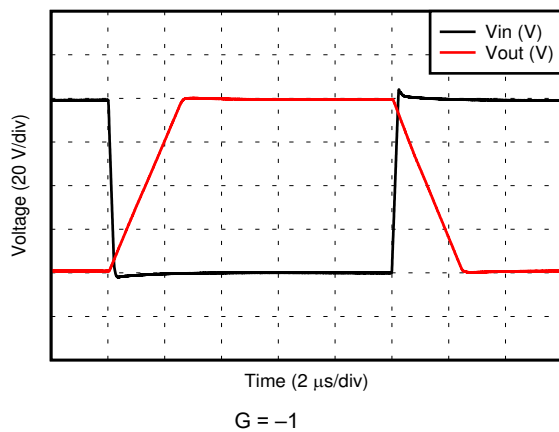

Figure 6-41. Large-Signal Step Response

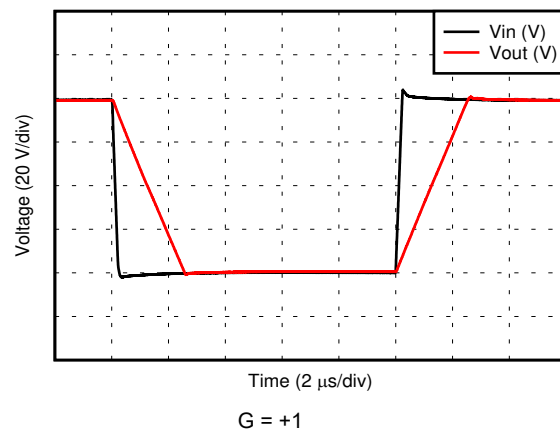

Figure 6-42. Large-Signal Step Response

6.6 Typical Characteristics (continued)

at $T_A = 25^\circ\text{C}$, $V_S = \pm 75\text{ V}$, and $R_L = 10\text{ k}\Omega$ connected to GND, output enabled (unless otherwise noted)

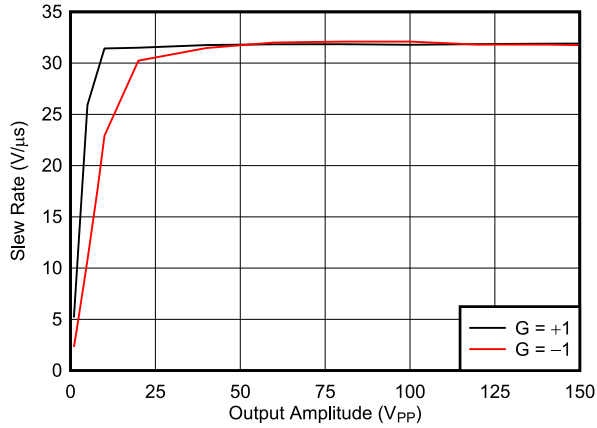

Figure 6-43. Slew Rate vs Output Step Size

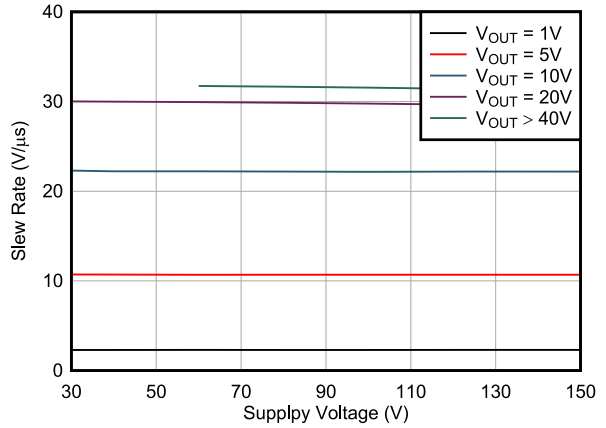

Figure 6-44. Slew Rate vs Supply Voltage (Inverting)

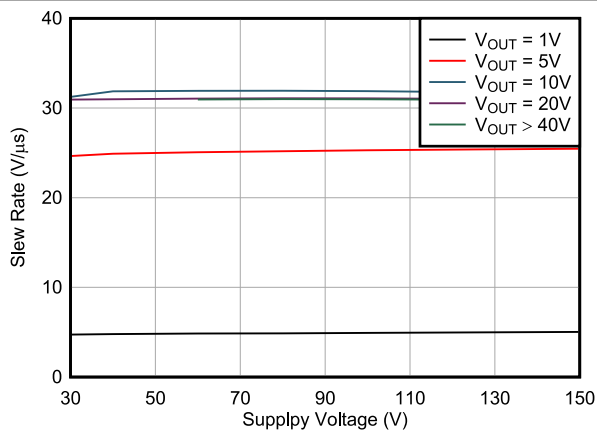

Figure 6-45. Slew Rate vs Supply Voltage (Noninverting)

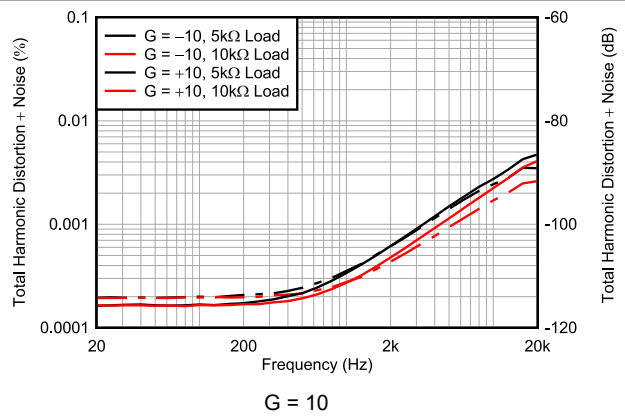

Figure 6-46. THD+N Ratio vs Frequency

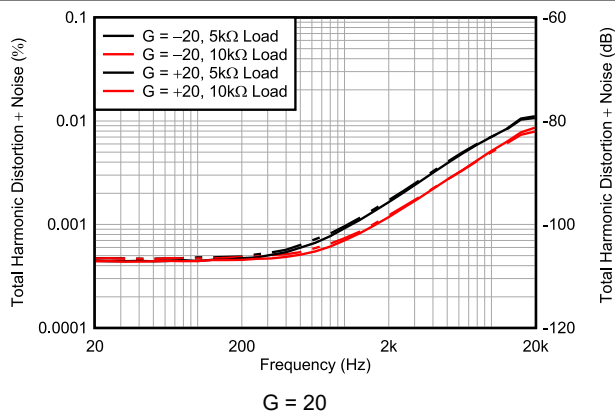

Figure 6-47. THD+N Ratio vs Frequency

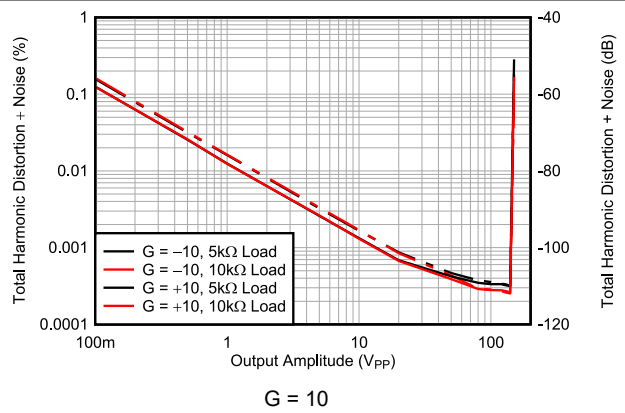
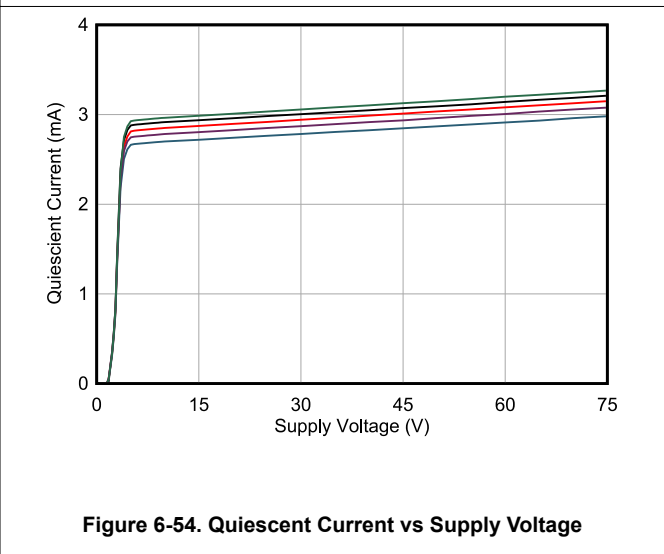
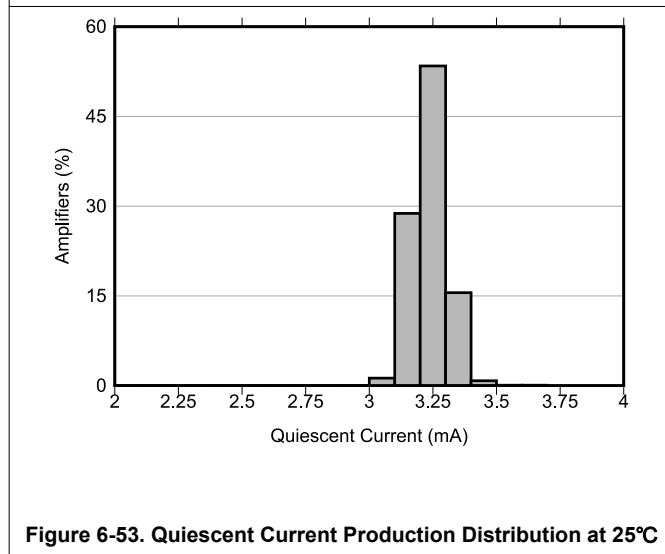
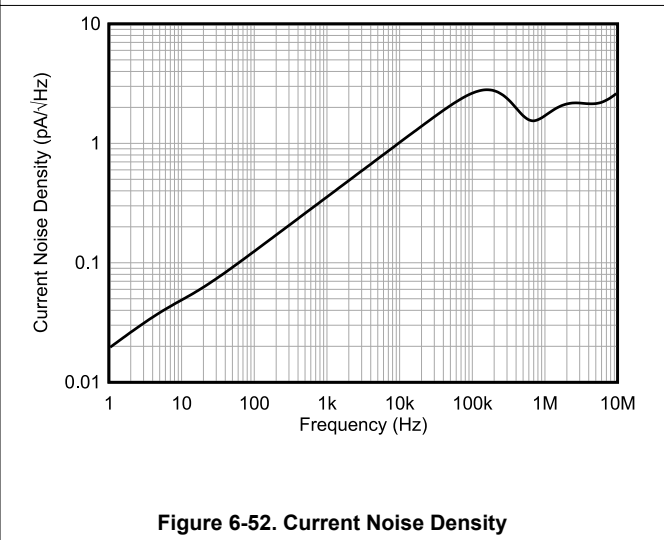
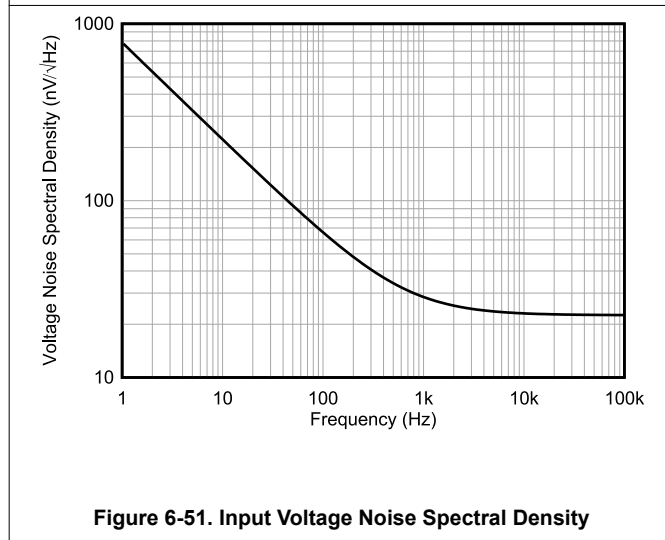
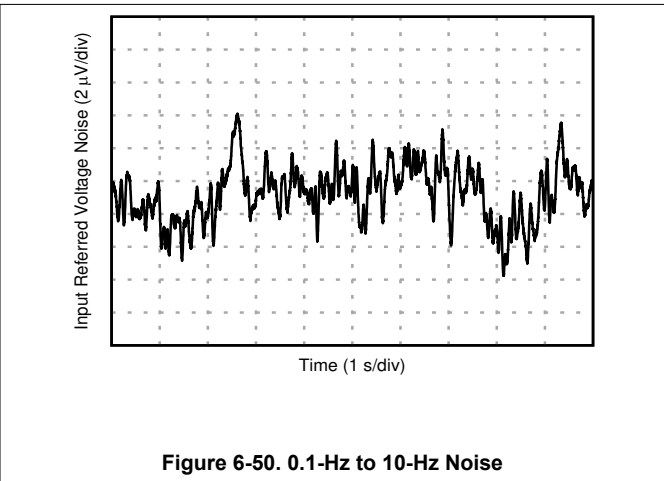
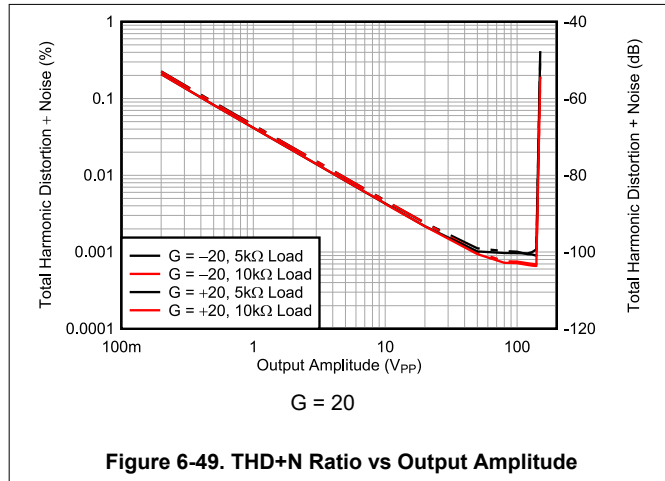

Figure 6-48. THD+N Ratio vs Output Amplitude

6.6 Typical Characteristics (continued)

at $T_A = 25^\circ\text{C}$, $V_S = \pm 75\text{ V}$, and $R_L = 10\text{ k}\Omega$ connected to GND, output enabled (unless otherwise noted)



6.6 Typical Characteristics (continued)

at $T_A = 25^\circ\text{C}$, $V_S = \pm 75\text{ V}$, and $R_L = 10\text{ k}\Omega$ connected to GND, output enabled (unless otherwise noted)

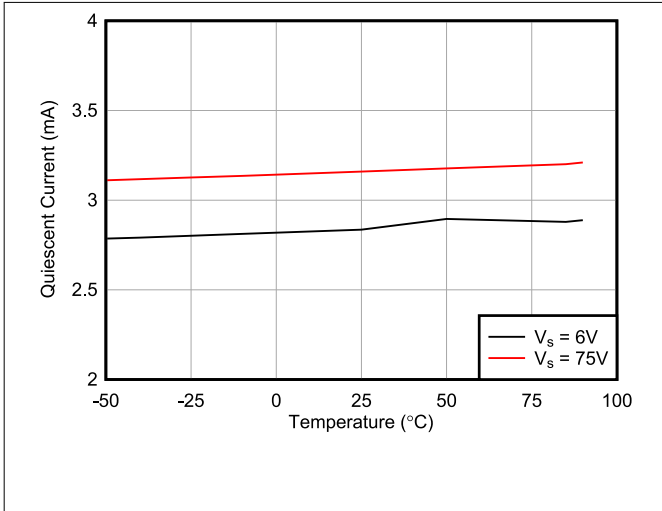

Figure 6-55. Quiescent Current vs Temperature

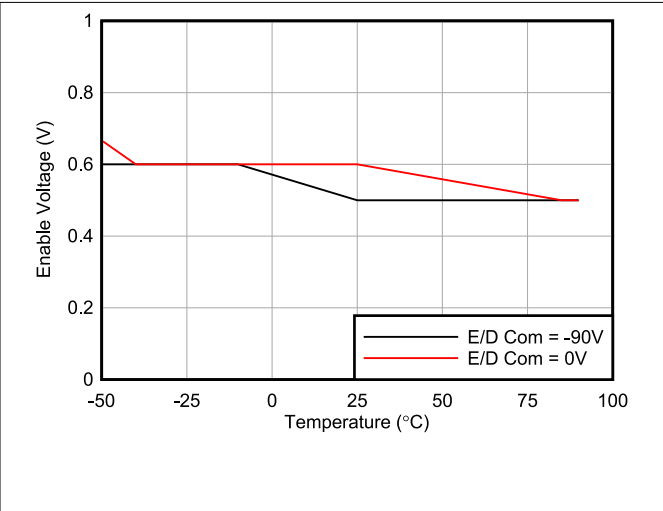

Figure 6-56. Status Flag Voltage vs Temperature

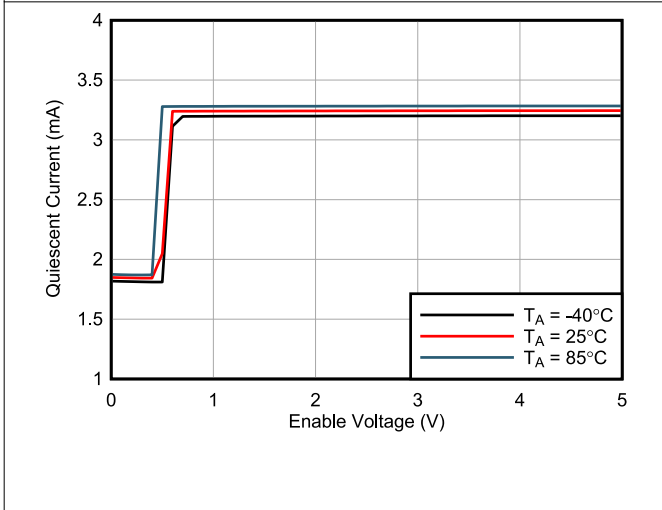

Figure 6-57. Quiescent Current vs Enable Voltage

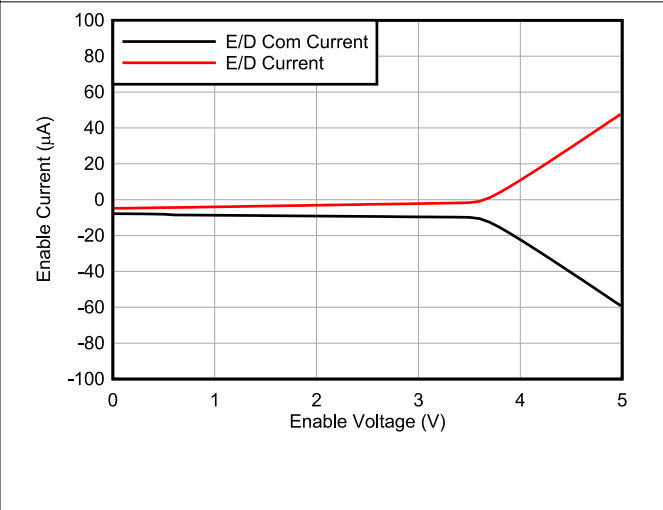

Figure 6-58. Enable Current vs Enable Voltage

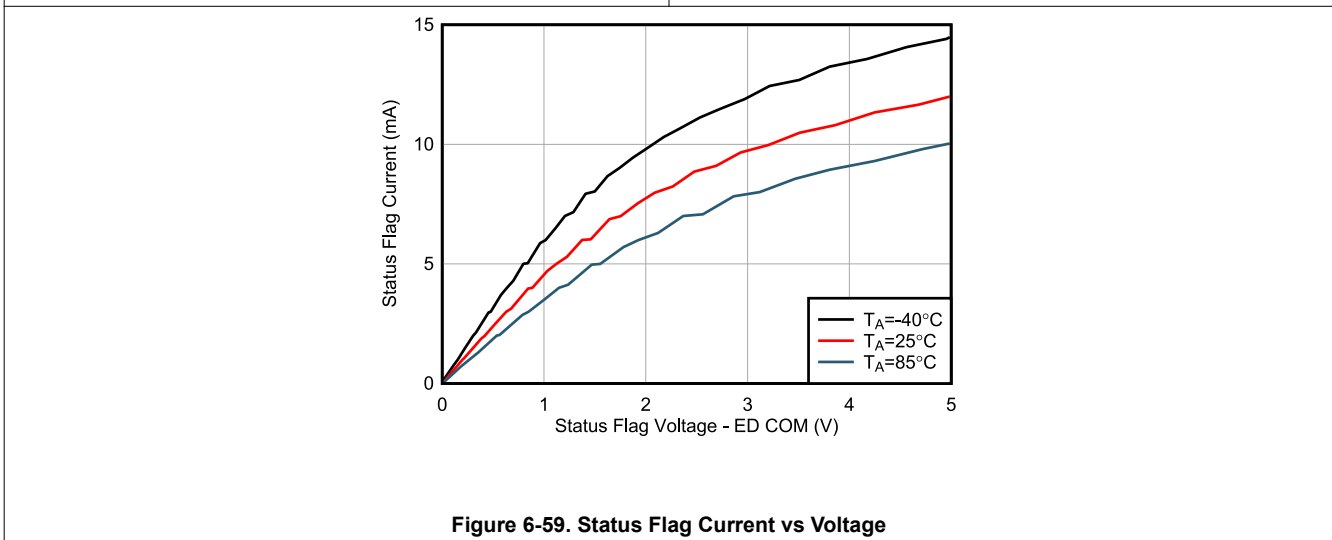

Figure 6-59. Status Flag Current vs Voltage

7 Detailed Description

7.1 Overview

The OPA455 is an operational amplifier (op amp) with a high voltage of 155 V, and a high current drive of 45 mA. This device is unity-gain stable, and features a gain-bandwidth product of 6.5 MHz. The high-voltage OPA455 offers excellent accuracy and wide output swing, and has no phase inversion problems that are typically found in similar op amps. The device can be applied in many common op-amp configurations requiring a supply voltage range from ± 6 V to ± 75 V.

The OPA455 features an enable-disable function that provides the ability to turn off the output stage and reduce power consumption when not being used. The device also features a Status Flag pin that indicates an overtemperature or overcurrent fault conditions.

7.2 Functional Block Diagram

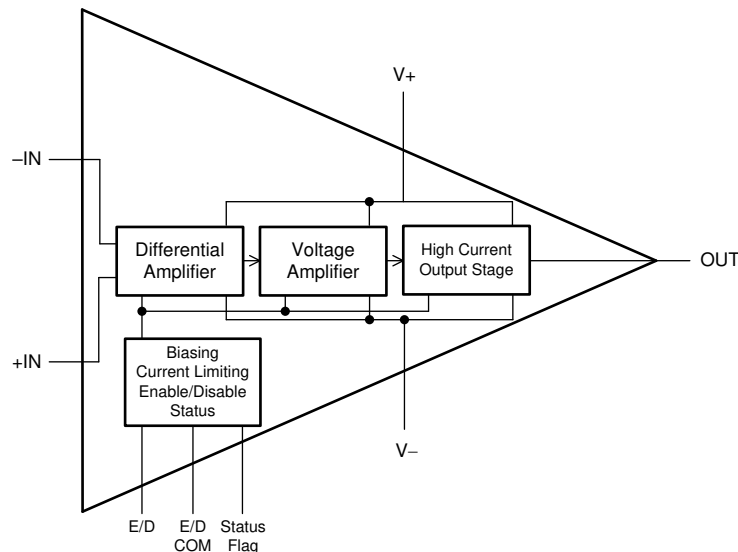

7.3 Feature Description

7.3.1 Status Flag Pin

The Status Flag pin indicates fault conditions and can be used in conjunction with the enable-disable function to implement fault control loops. This pin is triggered when the device enters an overtemperature or overcurrent fault condition.

7.3.2 Thermal Protection

The OPA455 features internal thermal protection that is triggered when the junction temperature is greater than 150°C. When the protection circuit is triggered, thermal shutdown occurs to allow the junction to return a safe operating temperature. Thermal shutdown enables the Status Flag pin, which indicates the device has entered the thermal shutdown state.

7.3.3 Current Limit

Current limiting is accomplished by internally limiting the drive to the output transistors. The output can supply the limited current continuously, unless the die temperature rises to 150°C and initiates thermal shutdown. With adequate heat dissipation, and use of the lowest possible supply voltage, the OPA455 can remain in current limit continuously without entering thermal shutdown. The best practice is to provide proper heat dissipation (either by a physical plate or by airflow) to remain well below the thermal shutdown threshold. For longest operational life of the device, keep the junction temperature below 125°C.

7.3.4 Enable and Disable

If left disconnected, the E/D Com pin is pulled near V^- (negative supply) by an internal $10\text{-}\mu\text{A}$ current source. When left floating, the E/D pin is held approximately 2 V above E/D Com by an internal $1\text{-}\mu\text{A}$ source. Even though active operation of the OPA455 results when the E/D and E/D Com pins are not connected, a moderately fast, negative-going signal capacitively coupled to the E/D pin can overpower the $1\text{-}\mu\text{A}$ pullup current and cause device shutdown. This behavior can appear as an oscillation and is encountered first near extreme cold temperatures. If the enable function is not used, a conservative approach is to connect E/D through a 30-pF capacitor to a low impedance source. Another alternative is the connection of an external current source from V^+ (positive supply) sufficient enough to hold the enable level above the shutdown threshold. Figure 7-1 shows a circuit that connects E/D and E/D Com. The E/D Com pin is limited to $(V^-) + 100\text{ V}$ to enable the use of digital ground in an application where the OPA455 power supply is $\pm 75\text{ V}$.

When the E/D pin is dropped to a voltage between 0 V and 0.65 V above the E/D Com pin voltage, the output of the OPA455 becomes disabled. While in this state, the impedance of the output increases to approximately $160\text{ k}\Omega$. Because the inputs are still active, an input signal might be passed to the output of the amplifier. The voltage at the amplifier output is reduced because of a drop across this output impedance, and may appear distorted compared to a normal operation output.

After the E/D pin voltage is raised to a voltage between 2.5 V and 5 V greater than the E/D Com, the output impedance returns to a normal state, and the amplifier operates normally.

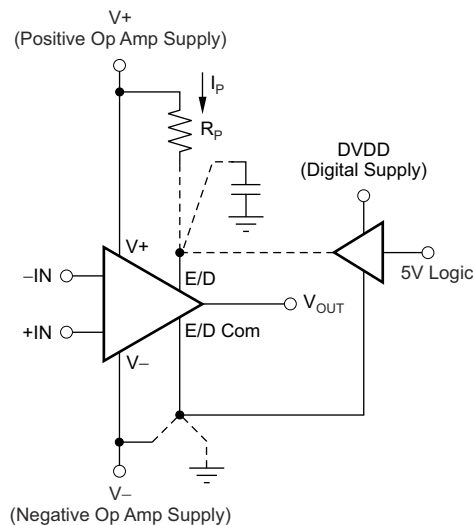

Figure 7-1. E/D and E/D Com

7.4 Device Functional Modes

A unique mode of the OPA455 is the output disable capability. This function conserves power during idle periods (quiescent current drops to approximately 1 mA). The output stage is disabled without disturbing the input signal path, not only saving power but also protecting the load. This feature makes disable useful for implementing external fault shutdown loops.

8 Application and Implementation

Note

Information in the following applications sections is not part of the TI component specification, and TI does not warrant its accuracy or completeness. TI's customers are responsible for determining suitability of components for their purposes. Customers should validate and test their design implementation to confirm system functionality.

8.1 Application Information

The OPA455 is a high-voltage, high-current operational amplifier capable of operating with supply voltages as high as ± 75 V (150 V), or as low as ± 6 V (12 V). The high-voltage process and design of the OPA455 allows the device to be used in applications where most operational amplifiers cannot be applied, such as high-voltage power-supply conditions, or when there is a need for very a high-output voltage swing. The output is capable of delivering up to ± 45 mA output current, or swinging within a few volts of the supply rails at moderate current levels. The OPA455 features input overvoltage protection, output current limiting, thermal protection, a status flag, and enable-disable capability.

8.2 Typical Applications

8.2.1 High DAC Gain Stage for Semiconductor Test Equipment

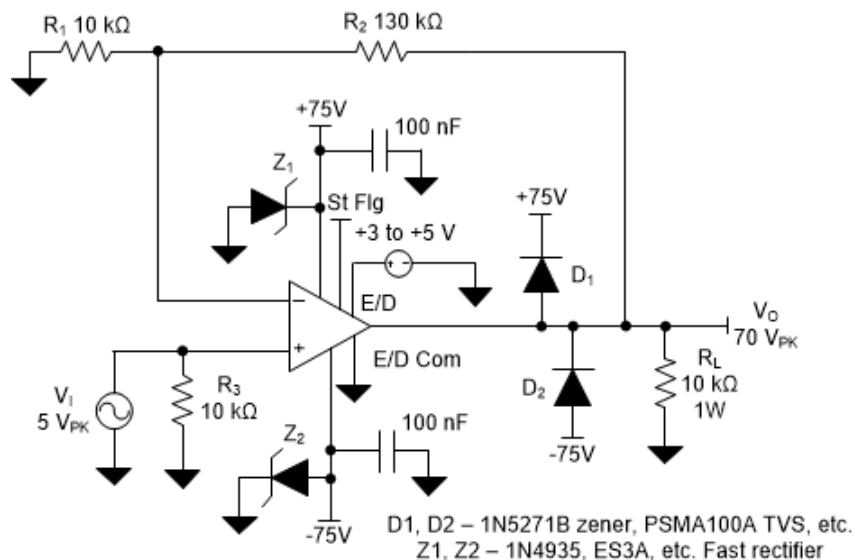

Figure 8-1. OPA455, High-Voltage Noninverting Amplifier, $A_v = 14$ V/V

8.2.1.1 Design Requirements

The OPA455 high-voltage op amp can be used in commonly applied op amp circuits, but with the added capability of allowing for the use of much higher supply voltages. A very common application of an op amp is that of a noninverting amplifier with a gain of 1 V/V or higher. Figure 8-1 shows the OPA455 in a noninverting configuration.

The design requirements for this example circuit are:

- An input of 5 V_{pk}
- A noninverting gain of 14 V/V (22.9 dB)
- A peak output voltage of 70 V, while driving a 10 k Ω output load
- Correct biasing of E/D and E/D Com
- Protection against back electromagnetic force (EMF)
- Diodes to protect output from exceeding design and damaging load

8.2.1.2 Detailed Design Procedure

Figure 8-1 shows a noninverting circuit with a moderately high closed-loop gain (A_V) of 14 V/V (22.9 dB). In this example, a $5\text{-}V_{PK}$ ac signal is amplified to $70\text{ }V_{PK}$ across a $10\text{-}k\Omega$ load resistor connected to the output. The peak current for this application is 8.5 mA, and is well within the OPA455 output current capability. Higher output current, typically up to 30 mA, may be attained at the expense of the output swing to the supply rails.

The noninverting amplifier circuit shows the OPA455 enable-disable function. When placed in disabled mode, the op amp becomes nonfunctional, and the current consumption is reduced to approximately one-third to one-half of the enabled level. An enable active state occurs when the E/D pin is left open, or is biased 3 V to 5 V greater than the E/D Com voltage level. If biased between the E/D com level, to E/D Com + 0.65 V, the OPA455 disables. More information about this function is provided in the [Enable and Disable](#) section.

Op amps designed for high-voltage and high-power applications may encounter output loads that can be quite different than those used in low-voltage, low-power, op-amp applications. Although every effort is made to make a high-voltage op amp such as the OPA455 robust and tolerant of different supply and different output load conditions, some loads can present potentially harmful circumstances.

Purely resistive output loads operating within the current capability range of the OPA455 do not present an unsafe condition, provided the thermal requirements discussed in the [Layout](#) section. Complex loads that have inductive or capacitive reactive elements might present an unsafe condition, and must be fully considered and addressed before implementation.

A potentially destructive mechanism is the back EMF transient that can be generated when driving an inductive load. D_1 , D_2 , Z_1 and Z_2 in the noninverting circuit drawing have been added to the basic OPA455 amplifier circuit to provide protection in the event of back EMF. If the voltage at the OPA455 output attempts to momentarily rise above V_+ , D_1 becomes forward-biased and clamps the voltage between the output and V_+ pins. This clamp must be sufficient to protect the OPA455 output transistor. If the event causes the V_+ voltage to increase the power supply bypass capacitor, Z_1 , or both, a Zener diode or a transient voltage suppressor (TVS) can provide a path for the transient current to ground. D_2 and Z_2 provide the same protection in the negative supply circuit.

The OPA455 noninverting amplifier circuit with a closed-loop gain of 14 V/V has a small-signal, -3-dB bandwidth of nearly 800 kHz. However, the large-signal bandwidth is likely of greater importance in a high-output-voltage application. For that mode of operation, the slew rate of the op amp and the peak output swing voltage must be considered in order to determine the maximum large-signal bandwidth. The slew rate (SR) of the OPA455 is typically $6.5\text{ V}/\mu\text{s}$, or $6.5 \times 10^6\text{ V/s}$. Using the $70\text{-}V_{PK}$ output voltage available from the noninverting circuit drawing, the maximum large-signal bandwidth is calculated from the slew rate formula. [Equation 1](#), [Equation 2](#) and [Equation 3](#) show the calculation process.

$$SR = 2\pi \times f_{MAX} \times V_{PK} \quad (1)$$

$$f_{MAX} = SR / (2\pi \times V_{PK}) \quad (2)$$

$$f_{MAX} = 6.5 \times 10^6\text{ V/s} / (2 \times \pi \times 75\text{ V}) = 14.8\text{ kHz} \quad (3)$$

where

- $SR = 6.5 \times 10^6\text{ V/s}$
- $V_{PK} = 75\text{ V}$

The best design practice for when a typical specification, such as slew rate, is used for calculation is to allow for variability in the actual value of the specification because of device manufacturing variations. In this example, keeping the large signal f_{MAX} to 10 kHz is sufficient to make sure the output avoids slew rate limiting.

8.2.1.3 Application Curve

Figure 8-2 shows the OPA455 70-V_{PK} output produced from a 5-V_{PK}, 10-kHz sine input. The results were obtained from TINA-TI™ simulation software.

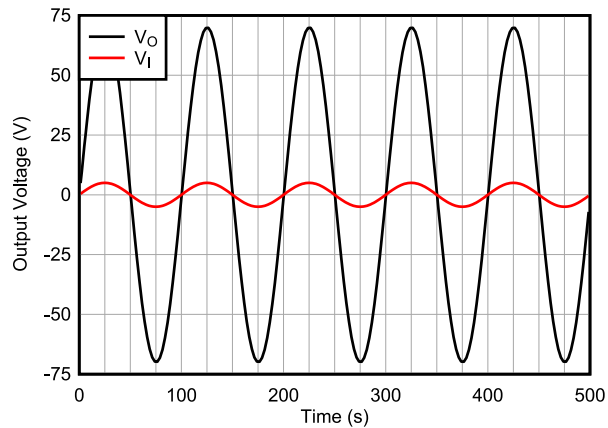

Figure 8-2. OPA455 Large-Signal Output With a 10-kHz Sine Input From TINA-TI™ Simulation Software

8.2.2 Improved Howland Current Pump for Bioimpedance Measurements in Multiparameter Patient Monitors

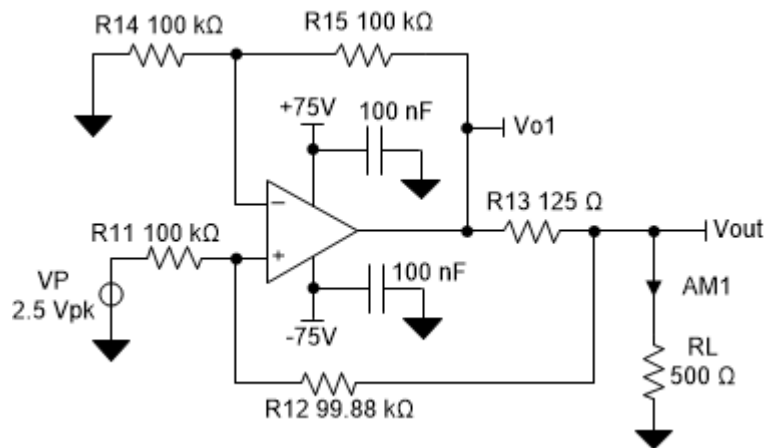

Figure 8-3. High-Voltage, 20-mA, Improved Howland Current Pump

8.2.2.1 Design Requirements

The OPA455 can be used to create a high-voltage, improved Howland current pump that provides a constant output current proportional to a single or differential input voltage applied to the pump inputs. The improved Howland current pump is described in section 3 of the [AN-1515 A Comprehensive Study of the Howland Current Pump application report](#). Information about how the current pump resistor values are determined for a specific combination of input voltage and corresponding output current are detailed in the report. Here, the OPA455 is used to provide a constant current output over a wide range of output load.

The design requirements for this example circuit are:

- Input voltage: 2.5 Vpk at 400 Hz
- Output voltage: 20 Vpk
- Output current: ± 20 mA in-phase with the output voltage

8.2.2.2 Detailed Design Procedure

The improved Howland current pump circuit is illustrated in [Figure 8-3](#). The OPA455 sources an output current of 20 mA when a low-voltage single-ended, 2.5-V reference voltage is applied to the circuit input. The source could be an actual 2.5-V precision reference. If the current-pump output current requires being set to different levels, a voltage output DAC can be used. If the input voltage polarity is reversed, the output current reverses direction, and 20 mA is sunk from the load through the OPA455 output.

The circuit provides the resistance values required to obtain a ± 20 -mA output current with the 2.5-V input voltage applied. The following can be used to select the resistors, thus setting the voltage gain and output current.

- R_{13} sets the gain, and is adjusted by the ratio of R_{14} / R_{15}
- Selecting a low value for R_{13} enables all other resistors to be high, limiting current through the feedback network
- The ratio of $R_{11} / (R_{12} + R_{13})$ must equal R_{14} / R_{15}
- If $R_{14} = R_{15}$, then $R_{12} = R_{11} - R_{13}$

Applying these relationships the resistors are selected or derived as follows:

- Let $R_{14} = R_{15} = 100 \text{ k}\Omega$
- $R_{13} = [(VP - VN) (R_{15} / R_{14})] / I_L = [(2.5 \text{ V} - 0 \text{ V}) (100 \text{ k}\Omega / 100 \text{ k}\Omega)] / 0.02 \text{ A} = 125 \Omega$
- $R_{12} = (R_{11} - R_{13}) = (100 \text{ k}\Omega - 125 \Omega) = 99.875 \text{ k}\Omega$

Verifying $R_{11} / (R_{12} + R_{13})$ must equal R_{14} / R_{15} requirement:

- $R_{12} = [R_{11}(R_{15} / R_{14})] - R_{13} = [100 \text{ k}\Omega (100 \text{ k}\Omega / 100 \text{ k}\Omega)] - 125 \Omega = 99.875 \text{ k}\Omega$

The resistor values for R_{11} through R_{15} are seen in the circuit drawing.

The load is set to be 500 Ω , the sourced output current through the load is 20 mA, and the output voltage is 10 V. The voltage directly at the OPA455 output 2.5 V higher, or 12.5 V, which compensates for the voltage drop across the 125- Ω R_{13} resistor. If needed., a feedback capacitor can be added to reduce the ac bandwidth of the improved Howland current pump circuit. In this example, no capacitor is used.

The improved Howland current pump output is limited to the combined effects of the OPA455 linear output voltage swing range, the voltage drop developed across R_{13} , and the voltage drop developed across load. For a particular output current, a maximum output voltage span can be achieved. This span is referred to as the output voltage compliance range.

The OPA455 current pump sources or sinks a constant current through a load resistance of 0 Ω on the low end, to just beyond 4.25 k Ω on the high end. This current range is portrayed in the dc transfer plot show in [Figure 8-4](#). As shown, the load can be vary from 0 Ω to 4.25 k Ω and the output remains within the span of linear output compliance range.

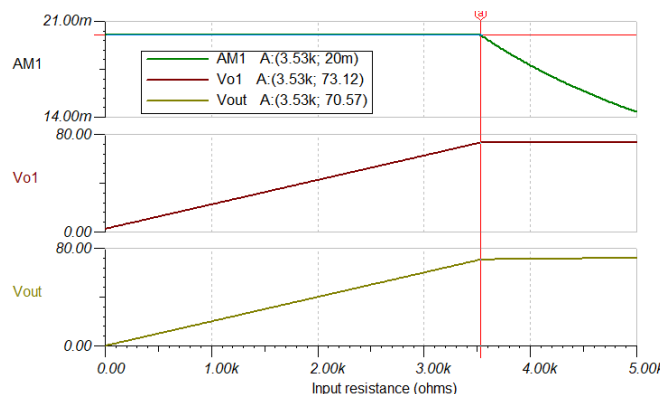

Figure 8-4. Output Voltage Compliance for an Improved Howland Current Pump

The 4.25-k Ω limit is determined by the maximum 70-V drop across the load, and the 2.5-V drop across R₁₃ when 20 mA flows through both. This voltage drop results in an output voltage of 87.5 V at the output of the OPA455, close to the positive swing limit. Beyond 4.25 k Ω , current-pump operation is forced outside the compliance range, and the output current is longer maintained at the correct level.

The OPA455 provides this wide output compliance range because of the wide, ± 75 -V power supply rating. If a standard ± 15 -V amplifier supply was used with the OPA455, or another amplifier rated for ± 15 -V supplies, the maximum load resistance is on the order of approximately 500 Ω to 600 Ω depending on the particular amplifier linear output range when delivering ± 20 mA. The wide supply range of the OPA455 enables the device to drive a much wider range of loads.

The improved Howland current pump can also be used to generate an accurate ac current with a peak output that matches a specified dc current level. A ± 20 -mA dc current source using the OPA455 has already been discussed; therefore, this current source is applied here to demonstrate how a 400-Hz, 20-mA current is produced.

The same improved Howland current pump circuit used previously is updated so that the 2.5-V dc voltage source has been replaced by a 400-Hz ac source with a peak voltage of 2.5 V, as shown in Figure 8-5. A sine wave is used in this circuit, but a triangle wave, square wave, and so on, can be used instead. The output current is dependent on the ac input voltage at any particular moment.

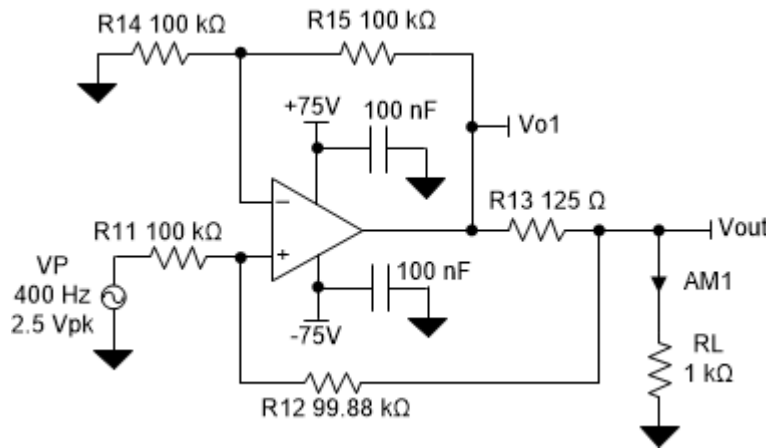

Figure 8-5. OPA455 Configured as a 400-Hz AC Current Generator

A 2.5-Vpk sine-wave source applied to the input point at R₁₁ results in a 20-mA peak current through the load, as shown in Figure 8-6. The load has been set to 1 k Ω , but any resistance that supports the output compliance range can be used.

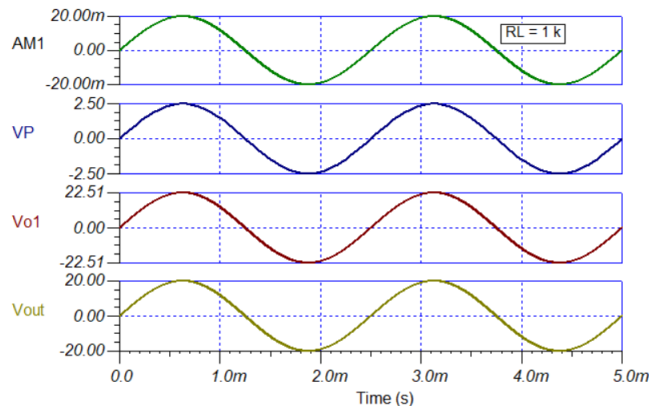

Figure 8-6. Improved Howland Current Pump Applied as a Peak AC-Current Generator

Make sure to consider the power handling ratings of the resistors used with a high-power or high-voltage amplifier such as the OPA455. In this design, when the OPA455 is providing 20 mA dc to a 4.25-k Ω load resistance, the dc power for the load and R₁₃ is simply:

- Load Power = $I^2 \cdot R_L = (20 \cdot 10^{-3} \text{ A})^2 (4.25 \cdot 10^3 \Omega) = 1.7 \text{ W}$
- Power R₁₃ = $I^2 \cdot R_{13} = (20 \cdot 10^{-3} \text{ A})^2 (125 \Omega) = 50 \text{ mW}$

Clearly, the power dissipation of the load requires attention. However, in this design, R₁₃ does not require high power dissipation under these operating conditions. The load must be rated to dissipate the 1.7 W over the expected operating temperature range for this example. Most often, resistor power dissipation is specified at an ambient temperature of 25°C, and reduces as temperature increases. The use of a resistor with a power rating greater than the power that must be dissipated is almost always necessary. For this example, the load may need to be rated for 3 W, or even 5 W, to make sure that the load does not overheat and maintains reliability. In any case, determine the power dissipation for the particular operating conditions. Be especially attentive to the power rating issue regarding surface-mount resistors. The thermal environment in which surface-mount resistors operate may be much different than a resistor exposed in free air.

The improved Howland current pump amplifier circuit relies on both negative and positive feedback for operation. More negative feedback than positive feedback is used, but that does not always provide stability when the output load characteristics are included. When unity-gain stable amplifiers such as the OPA455 are employed, and they drive a resistive load, the amplifier phase margin should be sufficient so that the circuit is stable. However, if the output load is complex, containing both resistive and reactive components (R±jX), certain combinations degrade the phase margin to the point where instability results. Instability is even more evident when this current pump is used to drive certain inductive loads.

When required, compensation is determined based on the particular circuit to which the OPA455 is being applied. Amplifier stability and compensation is a vast subject covered in numerous TI documents, and TI training programs, such as [TI Precision Labs – Op Amps](#).

9 Power Supply Recommendations

The OPA455 operates from power supplies up to ± 75 V, or a total of 150 V, with excellent performance. Most behavior remains unchanged throughout the full operating voltage range. A power-supply bypass capacitor of at least 0.1 μ F is required for proper operation. Make sure that the capacitor voltage rating is suitable for the high voltage across the full operating temperature range. Parameters that vary significantly with operating voltage are shown in the [Typical Characteristics](#) section.

Some applications do not require an equal positive and negative output voltage swing. Power-supply voltages do not have to be equal. The OPA455 operates with as little as 12 V between the supplies, and with up to 155 V between the supplies.

10 Layout

10.1 Layout Guidelines

10.1.1 Thermally-Enhanced PowerPAD™ Package

The OPA455 comes in an 8-pin SO PowerPAD package that provides an extremely low thermal resistance, $R_{\theta JC(bot)}$, path between the die and the exterior of the package. This package features an exposed thermal pad that has direct thermal contact with the die. Thus, excellent thermal performance is achieved by providing a good thermal path away from the thermal pad.

The OPA455 SO-8 PowerPAD is a standard-size SO-8 package constructed using a downset leadframe upon which the die is mounted, as [Figure 10-1](#) shows. This arrangement results in the leadframe being exposed as a thermal pad on the underside of the package. The thermal pad on the bottom of the device can then be soldered directly to the PCB, using the PCB as a heat sink. In addition, plated-through holes (vias) provide a low thermal resistance heat flow path to the back side of the PCB. This architecture enhances the OPA455 power dissipation capability significantly, eliminates the use of bulky heat sinks and slugs traditionally used in thermal packages, and allows the OPA455 to be easily mounted using standard PCB assembly techniques.

Note

The SO-8 PowerPAD is pin-compatible with standard SO-8 packages, and as such, the OPA455 is a drop-in replacement for operational amplifiers in existing sockets. Always solder the PowerPAD to the PCB V– plane, even with applications that have low power dissipation. Solder the device to the PCB to provide the necessary thermal, mechanical, and electrical connections between the leadframe die pad and the PCB.

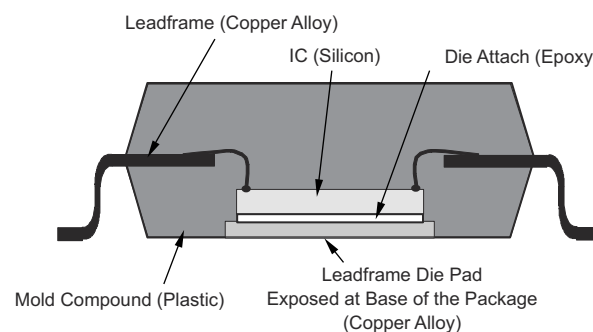

Figure 10-1. Cross Section View of a PowerPAD™ Package

10.1.2 PowerPAD™ Integrated Circuit Package Layout Guidelines

The PowerPAD integrated circuit package allows for both assembly and thermal management in one manufacturing operation. During the surface-mount solder operation (when the leads are being soldered), the thermal pad must be soldered to a copper area underneath the package. Through the use of thermal paths within this copper area, heat is conducted away from the package into either a ground plane or other heat-dissipating device. Always solder the PowerPAD to the PCB, even with applications that have low power dissipation. Follow these steps to attach the device to the PCB:

1. Connect the PowerPAD to the most negative supply voltage on the device, V_{-} .
2. Prepare the PCB with a top-side etch pattern. There must be etching for the leads, as well as etching for the thermal pad.
3. Thermal vias improve heat dissipation, but are not required. The thermal pad can connect to the PCB using an area equal to the pad size with no vias, but externally connected to V_{-} .
4. Place recommended holes in the area of the thermal pad. Recommended thermal land size and thermal via patterns for the SO-8 DDA package are shown in the thermal land pattern mechanical drawing appended at the end of this document. These holes must be 13 mils (0.013 in, or 0.3302 mm) in diameter. Keep the holes small, so that solder wicking through the holes is not a problem during reflow. The minimum recommended number of holes for the SO-8 PowerPAD package is five.
5. Additional vias can be placed anywhere along the thermal plane outside of the thermal pad area. These vias help dissipate the heat generated by the OPA455 device. These additional vias may be larger than the 13-mil diameter vias directly under the thermal pad because they are not in the thermal pad area to be soldered; thus, wicking is not a problem.
6. Connect all holes to the internal power plane of the correct voltage potential, V_{-} .
7. When connecting these holes to the plane, do not use the typical web or spoke via connection methodology. Web connections have a high thermal resistance connection that is useful for slowing the heat transfer during soldering operations, making the soldering of vias that have plane connections easier. In this application, however, low thermal resistance is desired for the most efficient heat transfer. Therefore, the holes under the OPA455 PowerPAD package must make the connections to the internal plane with a complete connection around the entire circumference of the plated-through hole.
8. The top-side solder mask must leave the pins of the package and the thermal pad area exposed. The bottom-side solder mask must cover the holes of the thermal pad area. This masking prevents solder from being pulled away from the thermal pad area during the reflow process.
9. Apply solder paste to the exposed thermal pad area and all of the device pins.
10. With these preparatory steps in place, simply place the device in position, and run through the solder reflow operation as with any standard surface-mount component.

This preparation results in a properly installed device. For detailed information on the PowerPAD package, including thermal modeling considerations and repair procedures, see the [PowerPAD™ Thermally Enhanced Package application report](#).

10.1.3 Pin Leakage

When operating the OPA455 with high supply voltages, parasitic leakages may occur between the inputs and the supplies. This effect is most noticeable at the noninverting input, +IN, when the input common-mode voltage is high compared to the negative supply voltage, V_{-} . To minimize this leakage, place guard tracing, driven at the same voltage as the input signal, alongside the input signal traces and pins.

10.1.4 Thermal Protection

Figure 10-2 shows the thermal shutdown behavior of a socketed OPA455 that internally dissipates 1 W. Unsoldered and in a socket, the $R_{\theta JA}$ of the DDA package is typically 128°C/W. With the socket at 25°C, the output stage temperature rises to the shutdown temperature of 150°C, which triggers automatic thermal shutdown of the device. The device remains in thermal shutdown (output is in a high-impedance state) until it cools to 130°C where the device is again powered. This thermal protection hysteresis feature typically prevents the amplifier from leaving the safe operating area, even with a direct short from the output to ground or either supply. The absolute maximum specification is 150 V, and the OPA455 must not be allowed to exceed 150 V under any condition. Failure as a result of breakdown, caused by spiking currents into inductive loads (particularly with elevated supply voltage), is not prevented by the thermal protection architecture.

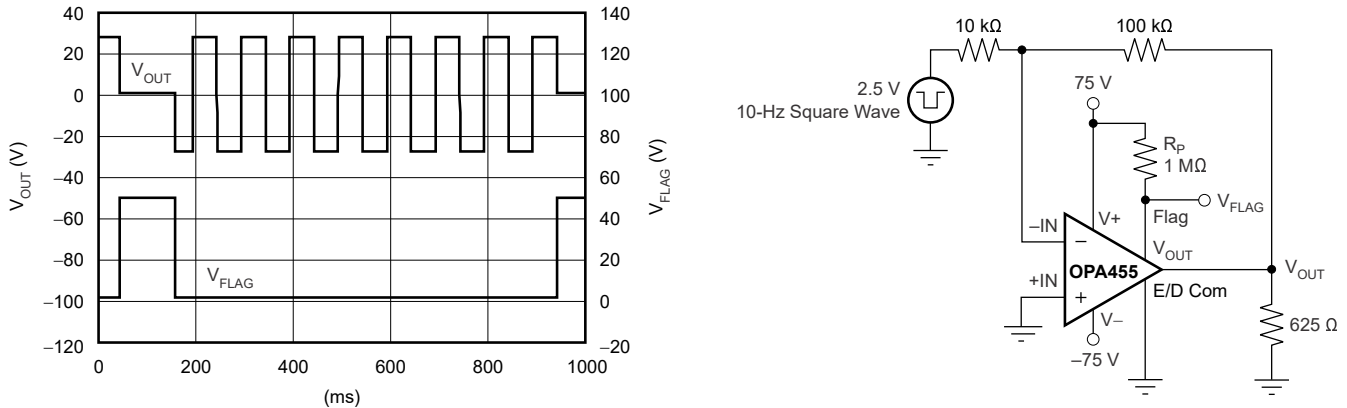

Figure 10-2. Thermal Shutdown

10.1.5 Power Dissipation

Power dissipation depends on power supply, signal, and load conditions. For dc signals, power dissipation is equal to the product of the output current times the voltage across the conducting output transistor, $P_D = I_L (V_S - V_O)$. Power dissipation can be minimized by using the lowest possible power-supply voltage necessary to provide the required output voltage swing.

For resistive loads, the maximum power dissipation occurs at a dc output voltage of one-half the power-supply voltage. Dissipation with ac signals is lower because the root-mean square (RMS) value determines heating. The [Instruments, Power Amplifier Stress and Power Handling Limitations application bulletin](#) explains how to calculate or measure dissipation with unusual loads or signals.

The OPA455 can supply output currents of up to 45 mA. Supplying this level of current is common for op amps operating from ± 15 -V supplies. However, with high supply voltages, internal power dissipation of the op amp can be quite high. Relative to the package size, operation from a single power supply (or unbalanced power supplies) can produce even greater power dissipation because a large voltage is impressed across the conducting output transistor. Applications with high power dissipation may require a heat sink or a heat spreader.

10.1.6 Heat Dissipation

Power dissipated in the OPA455 causes the junction temperature to rise. For reliable operation, junction temperature must be limited to 125°C, maximum. Maintaining a lower junction temperature always results in higher reliability. Some applications require a heat sink to make sure that the maximum operating junction temperature is not exceeded. Junction temperature can be determined according to [Equation 4](#):

$$T_J = T_A + P_D R_{\theta JA} \quad (4)$$

Package thermal resistance, $R_{\theta JA}$, is affected by mounting techniques and environments. Poor air circulation and use of sockets can significantly increase thermal resistance to the ambient environment. Many op amps placed closely together also increase the surrounding temperature. Best thermal performance is achieved by soldering the op amp onto a circuit board with wide printed circuit traces to allow greater conduction through the

op amp leads. Increasing circuit board copper area to approximately 0.5 in² decreases thermal resistance; however, minimal improvement occurs beyond 0.5 in², as shown in Figure 10-3.

For additional information on determining heat sink requirements, consult the [Heat Sinking—TO-3 Thermal Model application bulletin](#), available for download at www.ti.com.

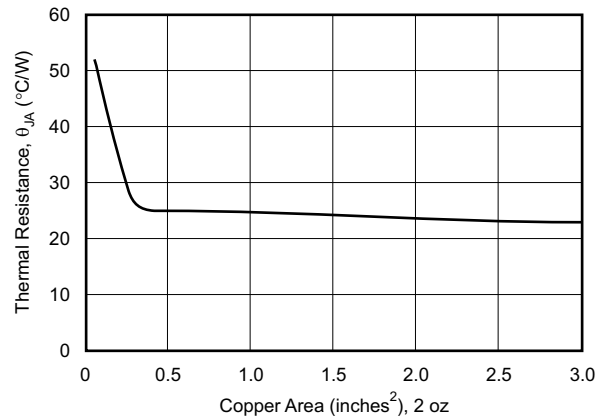

Figure 10-3. Thermal Resistance vs Circuit Board Copper Area

10.2 Layout Example

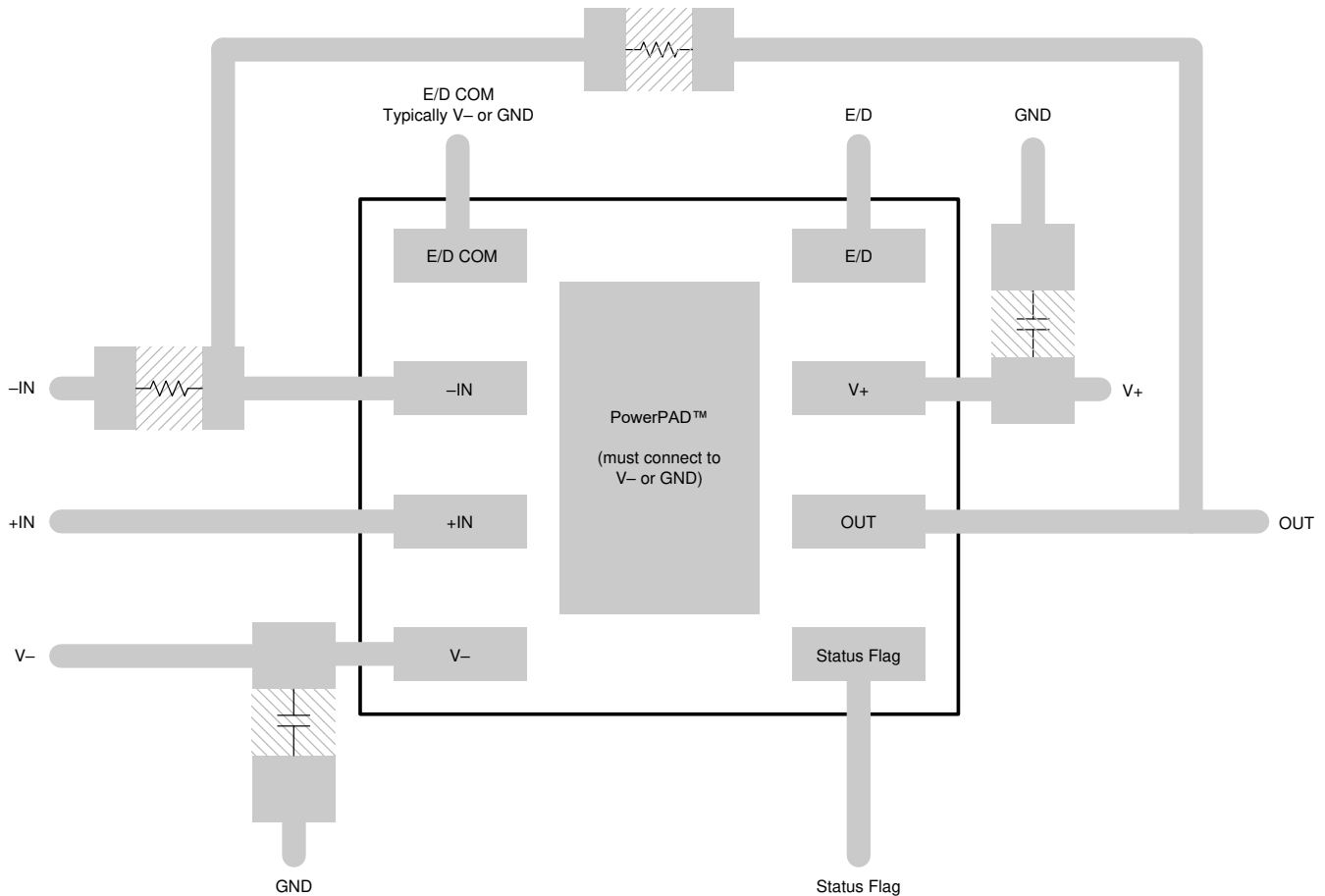

Figure 10-4. OPA455 Layout Example

11 Device and Documentation Support

11.1 Device Support

11.1.1 Development Support

11.1.1.1 TINA-TI™ Simulation Software (Free Download)

TINA™ is a simple, powerful, and easy-to-use circuit simulation program based on a SPICE engine. TINA-TI is a free, fully-functional version of the TINA software, preloaded with a library of macro models in addition to a range of both passive and active models. TINA-TI provides all the conventional dc, transient, and frequency domain analysis of SPICE, as well as additional design capabilities.

Available as a [free download](#) from the Analog eLab Design Center, TINA-TI offers extensive post-processing capability that allows users to format results in a variety of ways. Virtual instruments offer the ability to select input waveforms and probe circuit nodes, voltages, and waveforms, creating a dynamic quick-start tool.

Note

These files require that either the TINA software (from DesignSoft™) or TINA-TI software be installed. Download the free TINA-TI software from the [TINA-TI folder](#).

11.1.1.2 TI Precision Designs

TI Precision Designs are analog solutions created by TI's precision analog applications experts and offer the theory of operation, component selection, simulation, complete PCB schematic and layout, bill of materials, and measured performance of many useful circuits. TI Precision Designs are available online at: <http://www.ti.com/ww/en/analog/precision-designs/>.

11.1.1.3 WEBENCH® Filter Designer

[WEBENCH® Filter Designer](#) is a simple, powerful, and easy-to-use active filter design program. The WEBENCH® Filter Designer lets you create optimized filter designs using a selection of TI operational amplifiers and passive components from TI's vendor partners.

Available as a web-based tool from the WEBENCH® Design Center, [WEBENCH® Filter Designer](#) allows you to design, optimize, and simulate complete multistage active filter solutions within minutes.

11.2 Documentation Support

11.2.1 Related Documentation

The following documents are relevant to using the OPA455, and recommended for reference. All are available for download at www.ti.com unless otherwise noted.

- Texas Instruments, [Heat Sinking—TO-3 Thermal Model application bulletin](#)
- Texas Instruments, [Power Amplifier Stress and Power Handling Limitations application bulletin](#)
- Texas Instruments, [Op Amp Performance Analysis application bulletin](#)
- Texas Instruments, [Single-Supply Operation of Operational Amplifiers application bulletin](#)
- Texas Instruments, [Tuning in Amplifiers application bulletin](#)
- Texas Instruments, [PowerPAD™ Thermally Enhanced Package application report](#)

11.3 Support Resources

[TI E2E™ support forums](#) are an engineer's go-to source for fast, verified answers and design help — straight from the experts. Search existing answers or ask your own question to get the quick design help you need.

Linked content is provided "AS IS" by the respective contributors. They do not constitute TI specifications and do not necessarily reflect TI's views; see TI's [Terms of Use](#).

11.4 Trademarks

PowerPAD™, TINA-TI™, and TI E2E™ are trademarks of Texas Instruments.

TINA™ and DesignSoft™ are trademarks of DesignSoft, Inc.

WEBENCH® is a registered trademark of Texas Instruments.

All trademarks are the property of their respective owners.

11.5 Electrostatic Discharge Caution



This integrated circuit can be damaged by ESD. Texas Instruments recommends that all integrated circuits be handled with appropriate precautions. Failure to observe proper handling and installation procedures can cause damage.

ESD damage can range from subtle performance degradation to complete device failure. Precision integrated circuits may be more susceptible to damage because very small parametric changes could cause the device not to meet its published specifications.

11.6 Glossary

TI Glossary This glossary lists and explains terms, acronyms, and definitions.

12 Mechanical, Packaging, and Orderable Information

The following pages include mechanical, packaging, and orderable information. This information is the most current data available for the designated devices. This data is subject to change without notice and revision of this document. For browser-based versions of this data sheet, refer to the left-hand navigation.

PACKAGING INFORMATION

Orderable Device	Status (1)	Package Type	Package Drawing	Pins	Package Qty	Eco Plan (2)	Lead finish/ Ball material (6)	MSL Peak Temp (3)	Op Temp (°C)	Device Marking (4/5)	Samples
OPA455IDDA	ACTIVE	SO PowerPAD	DDA	8	75	RoHS & Green	NIPDAUAG	Level-2-260C-1 YEAR	-40 to 85	OPA455	Samples
OPA455IDDAR	ACTIVE	SO PowerPAD	DDA	8	2500	RoHS & Green	NIPDAUAG	Level-2-260C-1 YEAR	-40 to 85	OPA455	Samples

(1) The marketing status values are defined as follows:

ACTIVE: Product device recommended for new designs.

LIFEBUY: TI has announced that the device will be discontinued, and a lifetime-buy period is in effect.

NRND: Not recommended for new designs. Device is in production to support existing customers, but TI does not recommend using this part in a new design.

PREVIEW: Device has been announced but is not in production. Samples may or may not be available.

OBSOLETE: TI has discontinued the production of the device.

(2) **RoHS:** TI defines "RoHS" to mean semiconductor products that are compliant with the current EU RoHS requirements for all 10 RoHS substances, including the requirement that RoHS substance do not exceed 0.1% by weight in homogeneous materials. Where designed to be soldered at high temperatures, "RoHS" products are suitable for use in specified lead-free processes. TI may reference these types of products as "Pb-Free".

RoHS Exempt: TI defines "RoHS Exempt" to mean products that contain lead but are compliant with EU RoHS pursuant to a specific EU RoHS exemption.

Green: TI defines "Green" to mean the content of Chlorine (Cl) and Bromine (Br) based flame retardants meet JS709B low halogen requirements of <=1000ppm threshold. Antimony trioxide based flame retardants must also meet the <=1000ppm threshold requirement.

(3) MSL, Peak Temp. - The Moisture Sensitivity Level rating according to the JEDEC industry standard classifications, and peak solder temperature.

(4) There may be additional marking, which relates to the logo, the lot trace code information, or the environmental category on the device.

(5) Multiple Device Markings will be inside parentheses. Only one Device Marking contained in parentheses and separated by a "~" will appear on a device. If a line is indented then it is a continuation of the previous line and the two combined represent the entire Device Marking for that device.

(6) Lead finish/Ball material - Orderable Devices may have multiple material finish options. Finish options are separated by a vertical ruled line. Lead finish/Ball material values may wrap to two lines if the finish value exceeds the maximum column width.

Important Information and Disclaimer:The information provided on this page represents TI's knowledge and belief as of the date that it is provided. TI bases its knowledge and belief on information provided by third parties, and makes no representation or warranty as to the accuracy of such information. Efforts are underway to better integrate information from third parties. TI has taken and continues to take reasonable steps to provide representative and accurate information but may not have conducted destructive testing or chemical analysis on incoming materials and chemicals. TI and TI suppliers consider certain information to be proprietary, and thus CAS numbers and other limited information may not be available for release.

In no event shall TI's liability arising out of such information exceed the total purchase price of the TI part(s) at issue in this document sold by TI to Customer on an annual basis.

TAPE AND REEL INFORMATION



QUADRANT ASSIGNMENTS FOR PIN 1 ORIENTATION IN TAPE



*All dimensions are nominal

Device	Package Type	Package Drawing	Pins	SPQ	Reel Diameter (mm)	Reel Width W1 (mm)	A0 (mm)	B0 (mm)	K0 (mm)	P1 (mm)	W (mm)	Pin1 Quadrant
OPA455IDDAR	SO Power PAD	DDA	8	2500	330.0	12.8	6.4	5.2	2.1	8.0	12.0	Q1

TAPE AND REEL BOX DIMENSIONS



*All dimensions are nominal

Device	Package Type	Package Drawing	Pins	SPQ	Length (mm)	Width (mm)	Height (mm)
OPA455IDDAR	SO PowerPAD	DDA	8	2500	366.0	364.0	50.0



Images above are just a representation of the package family, actual package may vary.
Refer to the product data sheet for package details.

DDA0008J

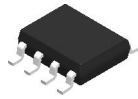

PACKAGE OUTLINE

PowerPAD™ SOIC - 1.7 mm max height

PLASTIC SMALL OUTLINE

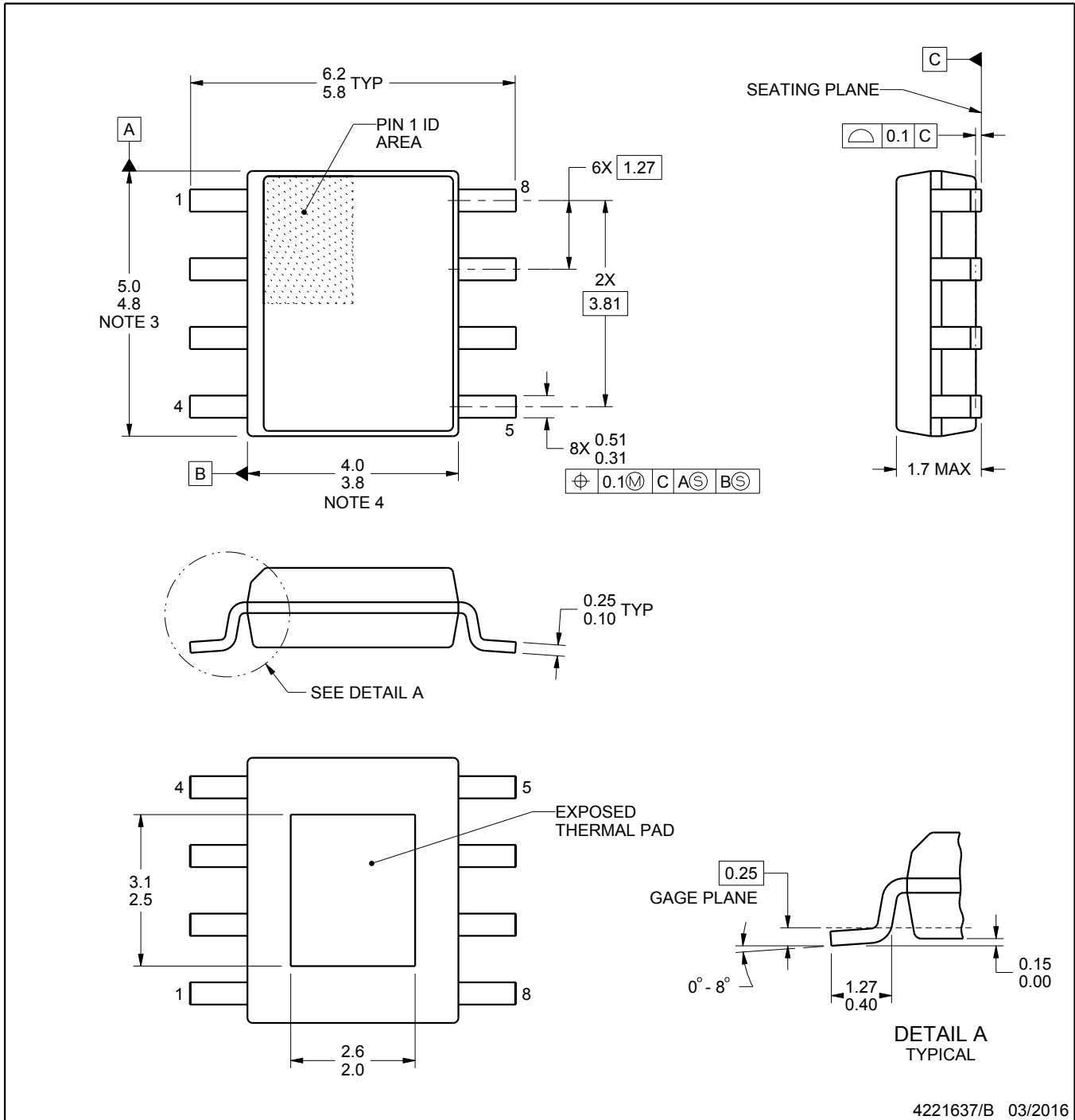

PowerPAD is a trademark of Texas Instruments.

NOTES:

1. All linear dimensions are in millimeters. Any dimensions in parenthesis are for reference only. Dimensioning and tolerancing per ASME Y14.5M.
2. This drawing is subject to change without notice.
3. This dimension does not include mold flash, protrusions, or gate burrs. Mold flash, protrusions, or gate burrs shall not exceed 0.15 mm per side.
4. This dimension does not include interlead flash. Interlead flash shall not exceed 0.25 mm per side.
5. Reference JEDEC registration MS-012, variation BA.

EXAMPLE BOARD LAYOUT

DDA0008J

PowerPAD™ SOIC - 1.7 mm max height

PLASTIC SMALL OUTLINE

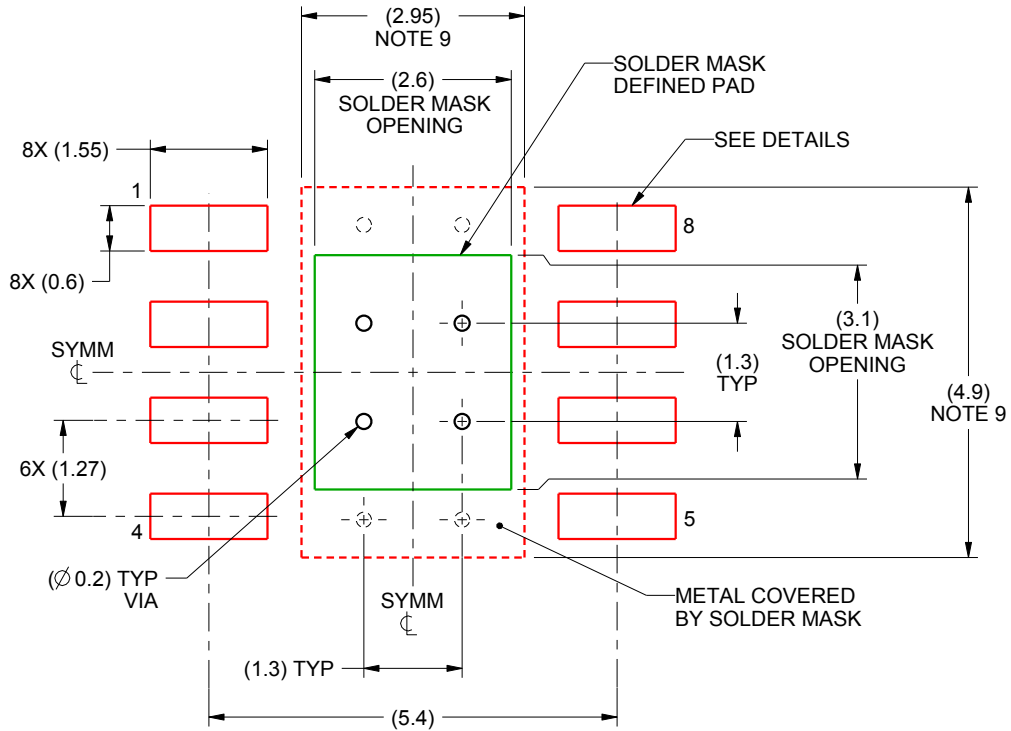

LAND PATTERN EXAMPLE
SCALE:10X

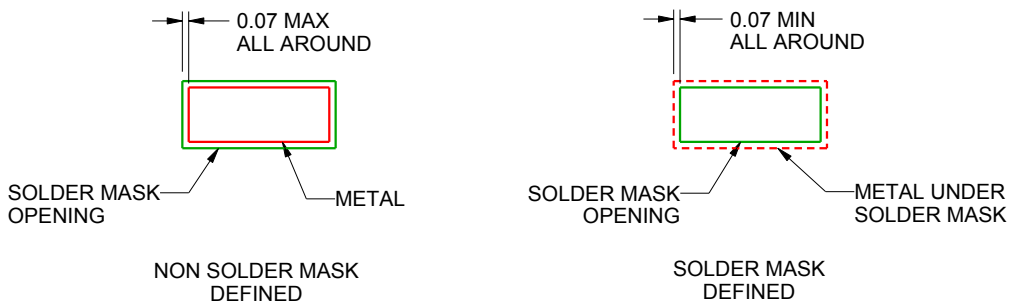

SOLDER MASK DETAILS

4221637/B 03/2016

NOTES: (continued)

- 6. Publication IPC-7351 may have alternate designs.
- 7. Solder mask tolerances between and around signal pads can vary based on board fabrication site.
- 8. This package is designed to be soldered to a thermal pad on the board. For more information, see Texas Instruments literature numbers SLMA002 (www.ti.com/lit/slma002) and SLMA004 (www.ti.com/lit/slma004).
- 9. Size of metal pad may vary due to creepage requirement.

EXAMPLE STENCIL DESIGN

DDA0008J

PowerPAD™ SOIC - 1.7 mm max height

PLASTIC SMALL OUTLINE

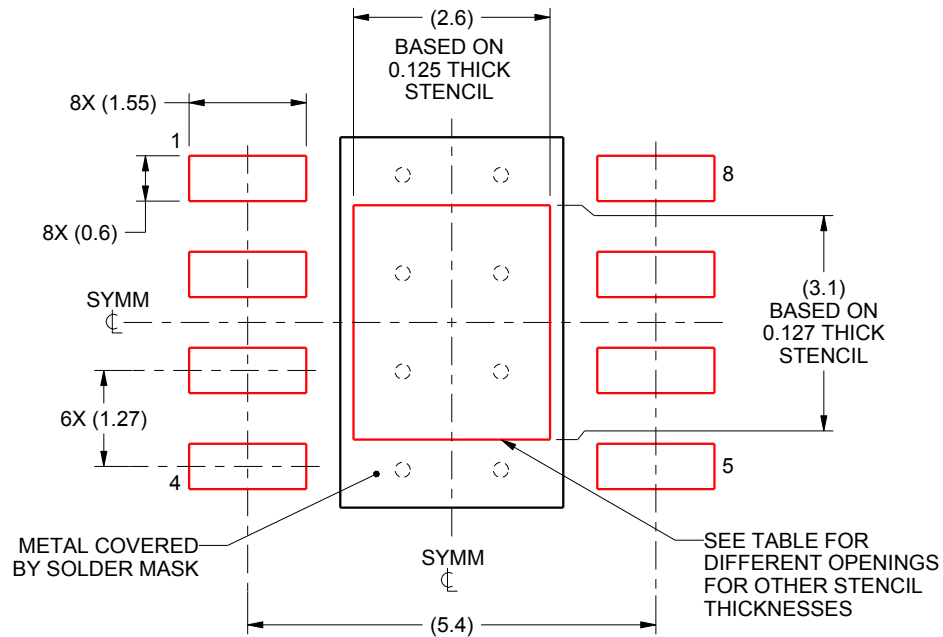

SOLDER PASTE EXAMPLE
 EXPOSED PAD
 100% PRINTED SOLDER COVERAGE BY AREA
 SCALE:10X

STENCIL THICKNESS	SOLDER STENCIL OPENING
0.1	2.91 X 3.47
0.125	2.6 X 3.1 (SHOWN)
0.150	2.37 X 2.83
0.175	2.20 X 2.62

4221637/B 03/2016

NOTES: (continued)

- 10. Laser cutting apertures with trapezoidal walls and rounded corners may offer better paste release. IPC-7525 may have alternate design recommendations.
- 11. Board assembly site may have different recommendations for stencil design.

IMPORTANT NOTICE AND DISCLAIMER

TI PROVIDES TECHNICAL AND RELIABILITY DATA (INCLUDING DATASHEETS), DESIGN RESOURCES (INCLUDING REFERENCE DESIGNS), APPLICATION OR OTHER DESIGN ADVICE, WEB TOOLS, SAFETY INFORMATION, AND OTHER RESOURCES "AS IS" AND WITH ALL FAULTS, AND DISCLAIMS ALL WARRANTIES, EXPRESS AND IMPLIED, INCLUDING WITHOUT LIMITATION ANY IMPLIED WARRANTIES OF MERCHANTABILITY, FITNESS FOR A PARTICULAR PURPOSE OR NON-INFRINGEMENT OF THIRD PARTY INTELLECTUAL PROPERTY RIGHTS.

These resources are intended for skilled developers designing with TI products. You are solely responsible for (1) selecting the appropriate TI products for your application, (2) designing, validating and testing your application, and (3) ensuring your application meets applicable standards, and any other safety, security, or other requirements. These resources are subject to change without notice. TI grants you permission to use these resources only for development of an application that uses the TI products described in the resource. Other reproduction and display of these resources is prohibited. No license is granted to any other TI intellectual property right or to any third party intellectual property right. TI disclaims responsibility for, and you will fully indemnify TI and its representatives against, any claims, damages, costs, losses, and liabilities arising out of your use of these resources.

TI's products are provided subject to TI's Terms of Sale (www.ti.com/legal/termsofsale.html) or other applicable terms available either on ti.com or provided in conjunction with such TI products. TI's provision of these resources does not expand or otherwise alter TI's applicable warranties or warranty disclaimers for TI products.

Mailing Address: Texas Instruments, Post Office Box 655303, Dallas, Texas 75265
Copyright © 2020, Texas Instruments Incorporated