

National Semiconductor is now part of
Texas Instruments.

Search <http://www.ti.com/> for the latest technical
information and details on our current products and services.

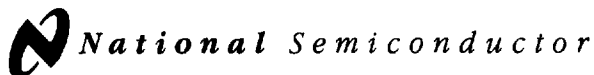

DS8922/DS8922A/DS8923/DS8923A TRI-STATE® RS-422 Dual Differential Line Driver and Receiver Pairs

General Description

The DS8922/22A and DS8923/23A are Dual Differential Line Driver and Receiver pairs. These devices are designed specifically for applications meeting the ST506, ST412 and ESDI Disk Drive Standards. In addition, the devices meet the requirements of the EIA Standard RS-422.

These devices offer an input sensitivity of 200 mV over a $\pm 7V$ common mode operating range. Hysteresis is incorporated (typically 70 mV) to improve noise margin for slowly changing input waveforms. An input fail-safe circuit is provided such that if the receiver inputs are open the output assumes the logical one state.

The DS8922A and DS8923A drivers are designed to provide unipolar differential drive to twisted pair or parallel wire transmission lines. Complementary outputs are logically ANDed and provide an output skew of 0.5 ns (typ.) with propagation delays of 12 ns.

Both devices feature TRI-STATE outputs. The DS8922/22A have independent control functions common to a driver and receiver pair. The DS8923/23A have separate driver and receiver control functions.

Power up/down circuitry is featured which will TRI-STATE the outputs and prevent erroneous glitches on the transmission lines during system power up or power down operation.

The DS8922/22A and DS8923/23A are designed to be compatible with TTL and CMOS.

Features

- 12 ns typical propagation delay
- Output skew— ± 0.5 ns typical
- Meets the requirements of EIA Standard RS-422
- Complementary Driver Outputs
- High differential or common-mode input voltage ranges of $\pm 7V$
- $\pm 0.2V$ receiver sensitivity over the input voltage range
- Receiver input fail-safe circuitry
- Receiver input hysteresis—70 mV typical
- Glitch free power up/down
- TRI-STATE outputs

Connection Diagrams

DS8922A Dual-In-Line

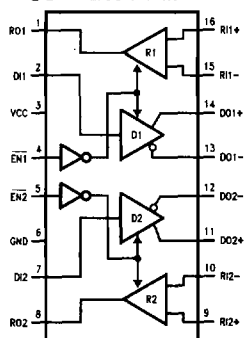

TL/F/8511-1

Order Number DS8922M, DS8922N,
DS8922AM or DS8922AN
See NS Package Number M16A or N16A

DS8923A Dual-In-Line

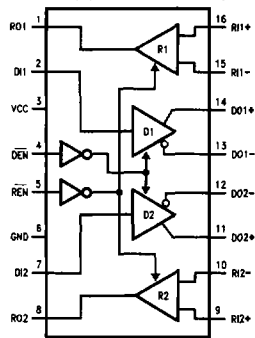

TL/F/8511-2

Order Number DS8923M, DS8923N,
DS8923AM or DS8923AN
See NS Package Number M16A or N16A

Truth Tables

DS8922/22A

EN1	EN2	RO1	RO2	DO1	DO2
0	0	ACTIVE	ACTIVE	ACTIVE	ACTIVE
1	0	HI-Z	ACTIVE	HI-Z	ACTIVE
0	1	ACTIVE	HI-Z	ACTIVE	HI-Z
1	1	HI-Z	HI-Z	HI-Z	HI-Z

DS8923/23A

DEN	REN	RO1	RO2	DO1	DO2
0	0	ACTIVE	ACTIVE	ACTIVE	ACTIVE
1	0	ACTIVE	ACTIVE	HI-Z	HI-Z
0	1	HI-Z	HI-Z	ACTIVE	ACTIVE
1	1	HI-Z	HI-Z	HI-Z	HI-Z

Absolute Maximum Ratings (Note 1)

If Military/Aerospace specified devices are required, please contact the National Semiconductor Sales Office/Distributors for availability and specifications.

Supply Voltage	7V
Drive Input Voltage	-0.5V to +7V
Output Voltage	5.5V
Receiver Output Sink Current	50 mA
Receiver Input Voltage	±10V
Differential Input Voltage	±12V

Maximum Package Power Dissipation @ +25°C	
M Package	1300 mW
N Package	1450 mW
Derate M Package	10.4 mW/°C above +25°C
Derate N Package	11.6 mW/°C above +25°C
Storage Temperature Range	-65°C to +165°C
Lead Temp. (Soldering, 4 seconds)	260°C

Recommended Operating Conditions

	Min	Max	Units
Supply Voltage	4.5	5.5	V
Temperature (T _A)	0	70	°C

DS8922/22A and DS8923/23A Electrical Characteristics (Notes 2, 3, and 4)

Symbol	Conditions	Min	Typ	Max	Units
RECEIVER					
V _{TH}	-7V ≤ V _{CM} ≤ +7V	-200	±35	+200	mV
V _{HYST}	-7V ≤ V _{CM} ≤ +7V	15	70		mV
R _{IN}	V _{IN} = -7V, +7V (Other Input = GND)	4.0	6.0		kΩ
I _{IN}	V _{IN} = 10V			3.25	mA
	V _{IN} = -10V			-3.25	mA
V _{OH}	V _{CC} = MIN, I _{OH} = -400 μA	2.5			V
V _{OL}	V _{CC} = MAX, I _{OL} = 8 mA			0.5	V
I _{SC}	V _{CC} = MAX, V _{OUT} = 0V	-15		-100	mA
DRIVER					
V _{OH}	V _{CC} = MIN, I _{OH} = -20 mA	2.5			V
V _{OL}	V _{CC} = MIN, I _{OL} = +20 mA			0.5	V
I _{OFF}	V _{CC} = 0V, V _{OUT} = 5.5V			100	μA
V _T - V _T				0.4	V
V _T		2.0			V
V _{OS} - V _{OS}				0.4	V
I _{SC}	V _{CC} = MAX, V _{OUT} = 0V	-30		-150	mA
DRIVER and RECEIVER					
I _{OZ} TRI-STATE Leakage	V _{CC} = MAX	V _{OUT} = 2.5V		50	μA
		V _{OUT} = 0.4V		-50	μA
I _{CC}	V _{CC} = MAX	ACTIVE		76	mA
		TRI-STATE		78	mA
DRIVER and ENABLE INPUTS					
V _{IH}		2.0			V
V _{IL}				0.8	V
I _{IL}	V _{CC} = MAX, V _{IN} = 0.4V		-40	-200	μA
I _{IH}	V _{CC} = MAX, V _{IN} = 2.7V			20	μA
I _I	V _{CC} = MAX, V _{IN} = 7.0V			100	μA
V _{CL}	V _{CC} = MIN, I _{IN} = -18 mA			-1.5	V

Receiver Switching Characteristics (Figures 1, 2 and 3)

Parameter	Conditions	Min	Typ	Max		Units
				8922/23	8922A/23A	
T_{pLH}	CL = 30 pF		12	22.5	20	ns
T_{pHL}	CL = 30 pF		12	22.5	20	ns
$ T_{pLH} - T_{pHL} $	CL = 30 pF		0.5	5	3.5	ns
Skew (Channel to Channel)	CL = 30 pF		0.5	3.0	2.0	ns
T_{pLZ}	CL = 15 pF S2 Open		15			ns
T_{pHZ}	CL = 15 pF S1 Open		15			ns
T_{pZL}	CL = 30 pF S2 Open		20			ns
T_{pZH}	CL = 30 pF S1 Open		20			ns

Driver Switching Characteristics

Parameter	Conditions	Min	Typ	Max		Units
				8922/23	8922A/23A	
SINGLE ENDED CHARACTERISTICS (Figures 4, 5, 6 and 8)						
T_{pLH}	CL = 30 pF		12	15	15	ns
T_{pHL}	CL = 30 pF		12	15	15	ns
T_{TLH}	CL = 30 pF		5	10	10	ns
T_{THL}	CL = 30 pF		5	10	10	ns
$ T_{pLH} - T_{pHL} $	CL = 30 pF		0.5			ns
Skew	CL = 30 pF (Note 5)		0.5	5	3.5	ns
Skew (Channel to Channel)			0.5	3.0	2.0	ns
T_{pLZ}	CL = 30 pF		15			ns
T_{pHZ}	CL = 30 pF		15			ns
T_{pZL}	CL = 30 pF		20			ns
T_{pZH}	CL = 30 pF		20			ns
DIFFERENTIAL SWITCHING CHARACTERISTICS (Note 6, Figures 4 and 7)						
T_{pLH}	CL = 30 pF		12	15	15	ns
T_{pHL}	CL = 30 pF		12	15	15	ns
$ T_{pLH} - T_{pHL} $	CL = 30 pF		0.5	6.0	2.75	ns

Note 1: "Absolute Maximum Ratings" are those values beyond which the safety of the device cannot be guaranteed. They are not meant to imply that the device should be operated at these limits. The Table of "Electrical Characteristics" provides conditions for actual device operation.

Note 2: All currents into device pins are shown as positive values; all currents out of the device are shown as negative; all voltages are referenced to ground unless otherwise specified. All values shown as max or min are classified on absolute value basis.

Note 3: All typical values are $V_{CC} = 5V$, $T_A = 25^\circ C$.

Note 4: Only one output at a time should be shorted.

Note 5: Difference between complementary outputs at the 50% point.

Note 6: Differential Delays are defined as calculated results from single ended rise and fall time measurements. This approach in establishing AC performance specifications has been taken due to limitations of available Automatic Test Equipment (ATE).

The calculated ATE results assume a linear transition between measurement points and are a result of the following equations:

$$T_{cp} = \frac{(T_{fb} \times T_{rb}) - (T_{ra} \times T_{fa})}{T_{rb} - T_{ra} - T_{fa} + T_{fb}}$$

Where: T_{cp} = Crossing Point

T_{ra} , T_{rb} , T_{fa} and T_{fb} are time measurements with respect to the input.

Switching Time Waveforms

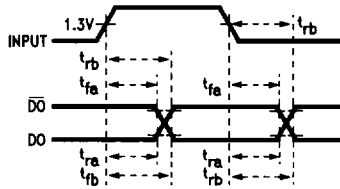

TL/F/8511-3

AC Test Circuits and Switching Waveforms

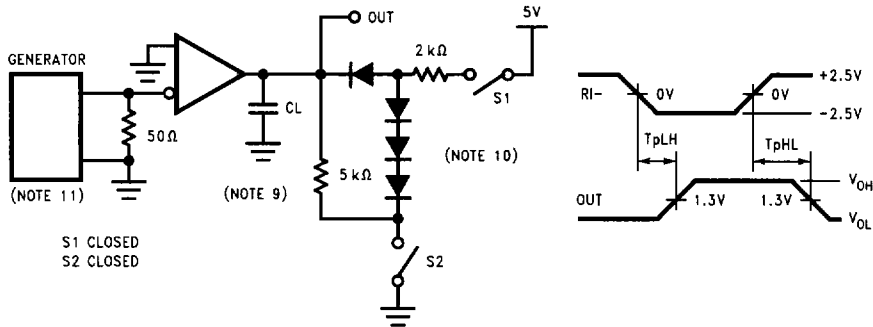

FIGURE 1

TL/F/8511-4

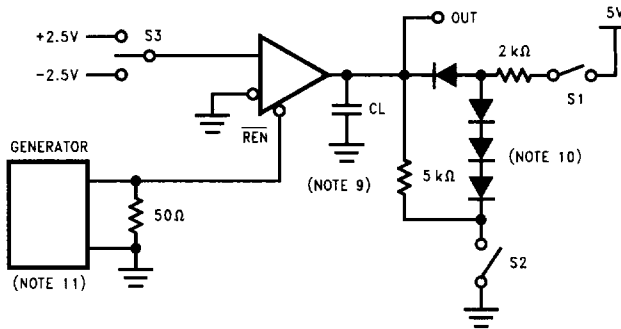

FIGURE 2

TL/F/8511-5

	S1	S2	S3
T _{PLZ}	Closed	Open	+2.5V
T _{PHZ}	Open	Closed	-2.5V
T _{PZL}	Closed	Open	+2.5V
T _{PZH}	Open	Closed	-2.5V

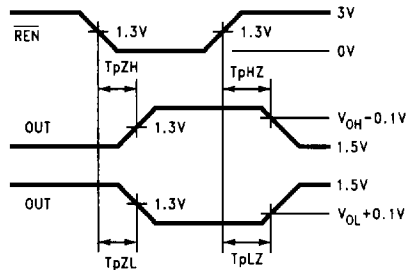
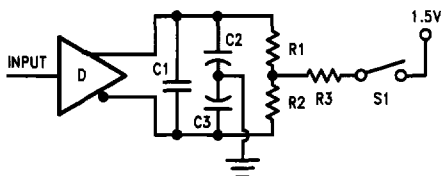

FIGURE 3

TL/F/8511-6

AC Test Circuit and Switching Waveforms (Continued)



NOTE: C1=C2=C3=30 pF, R1=R2=50 Ω, R3=500 Ω

TL/F/8511-7

FIGURE 4

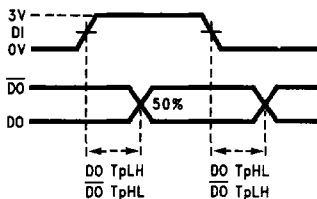

TL/F/8511-8

FIGURE 5

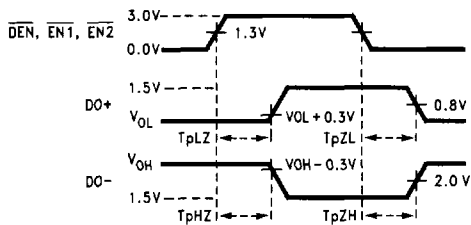

TL/F/8511-9

FIGURE 6

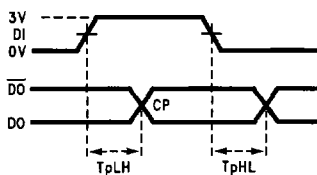

TL/F/8511-10

FIGURE 7

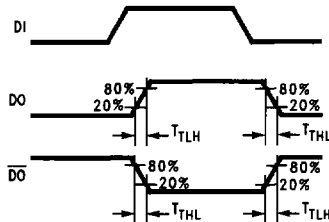

TL/F/8511-13

FIGURE 8

Typical Performance Characteristics (DS8923A)

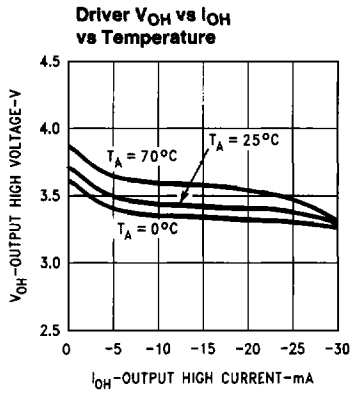

TL/F/8511-14

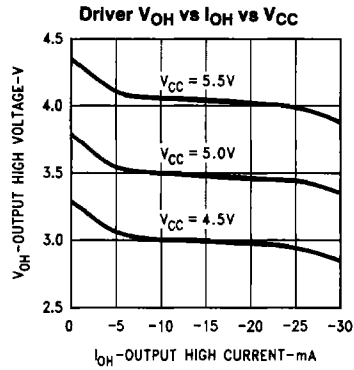

TL/F/8511-15

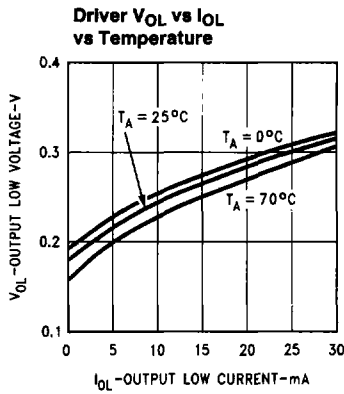

TL/F/8511-16

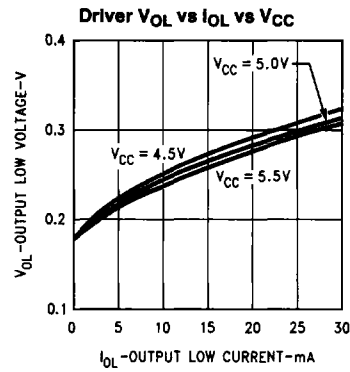

TL/F/8511-17

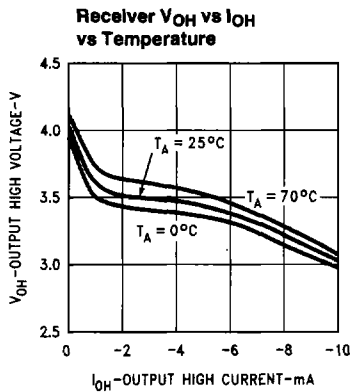

TL/F/8511-18

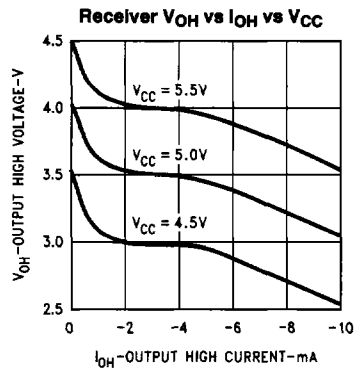

TL/F/8511-19

Typical Performance Characteristics (DS8923A) (Continued)

Receiver V_{OL} vs I_{OL} vs Temperature

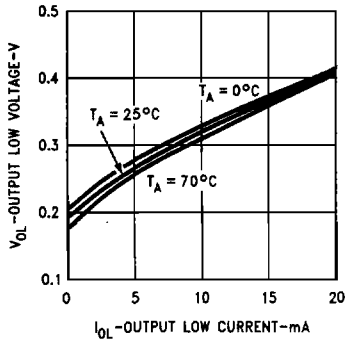

TL/F/8511-20

Receiver V_{OL} vs I_{OL} vs V_{CC}

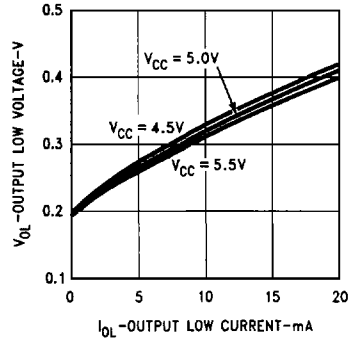

TL/F/8511-21

Driver Differential Propagation Delay vs Temperature

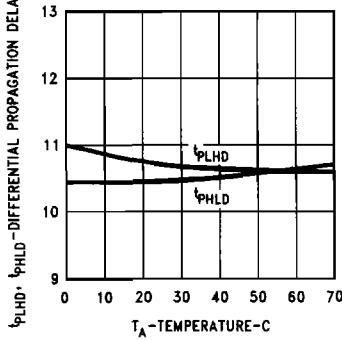

TL/F/8511-22

Driver Differential Propagation Delay vs V_{CC}

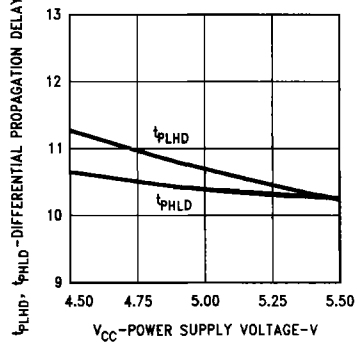

TL/F/8511-23

Receiver Propagation Delay vs Temperature

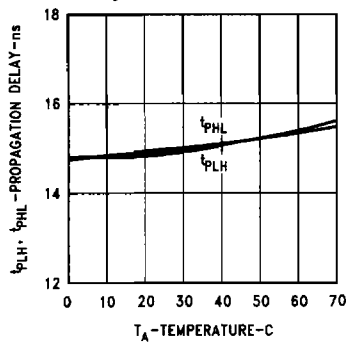

TL/F/8511-24

Receiver Propagation Delay vs V_{CC}

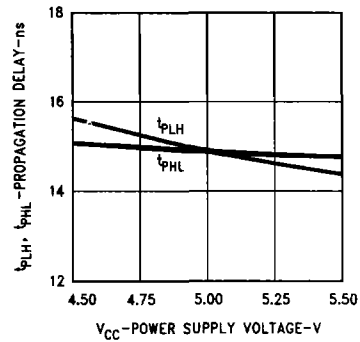

TL/F/8511-25

Typical Performance Characteristics (DS8923A) (Continued)

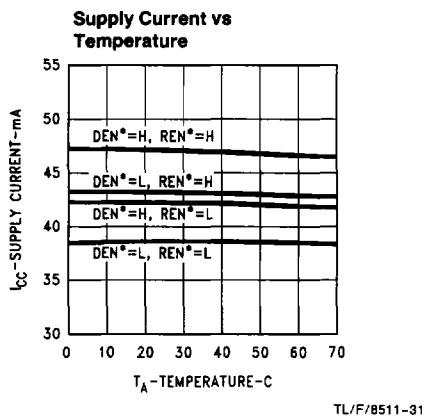
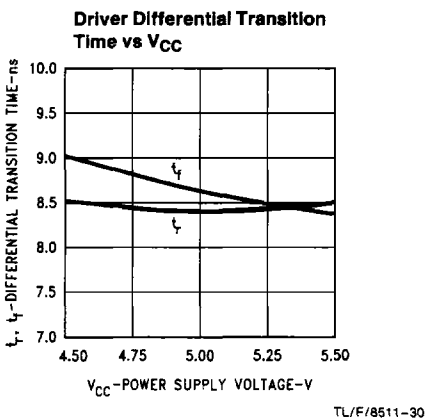
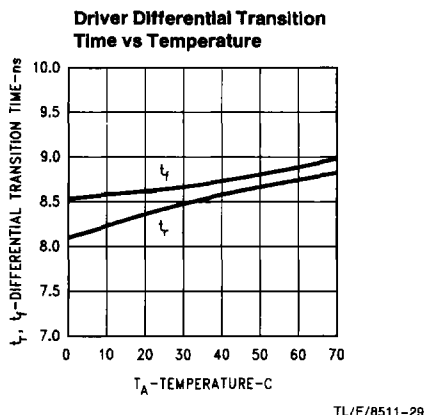
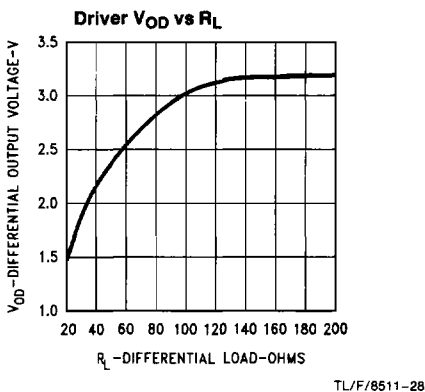
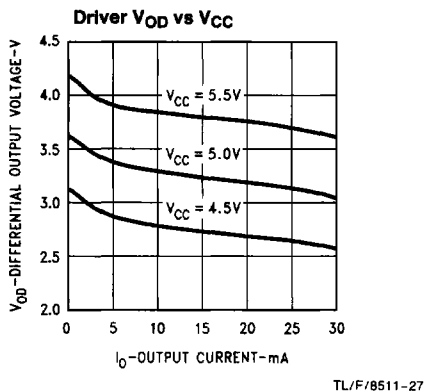
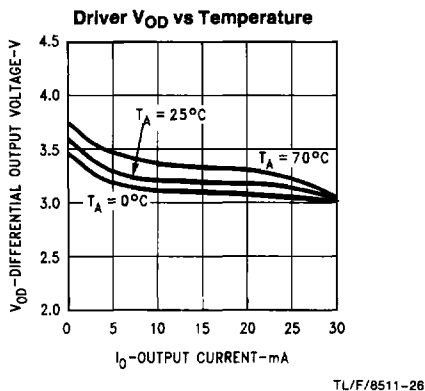

Typical Performance Characteristics (DS8923A) (Continued)

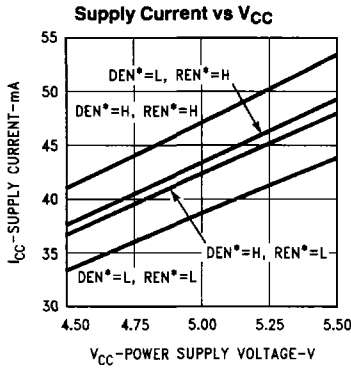

TL/F/8511-32

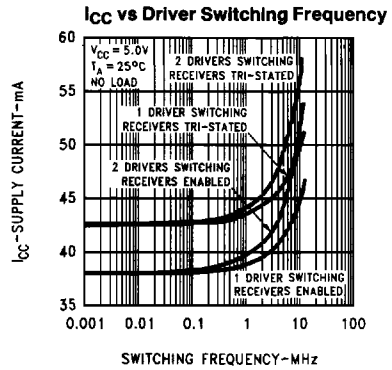

TL/F/8511-33

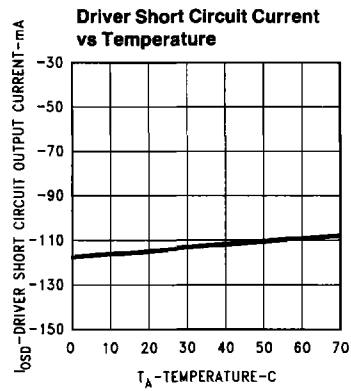

TL/F/8511-34

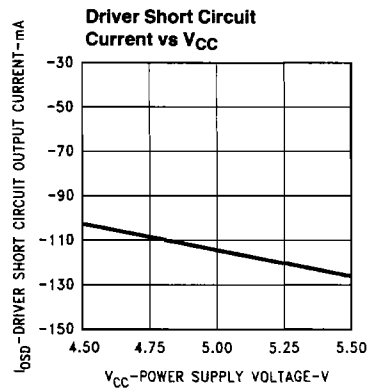

TL/F/8511-35

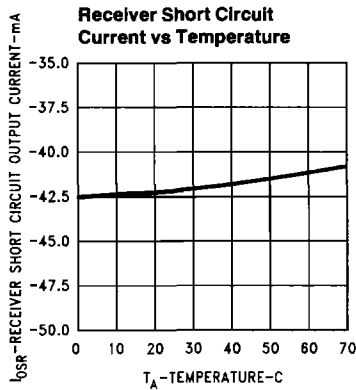

TL/F/8511-36

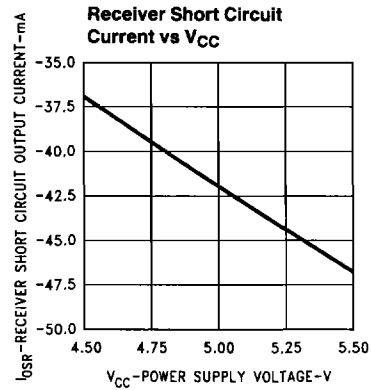

TL/F/8511-37

Typical Applications

ESDI Application

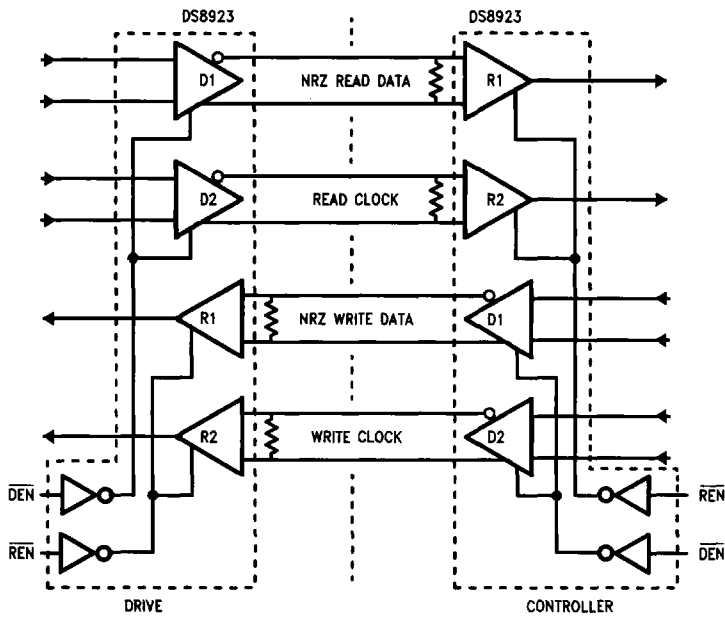

TL/F/8511-11

ST504 and ST412 Applications

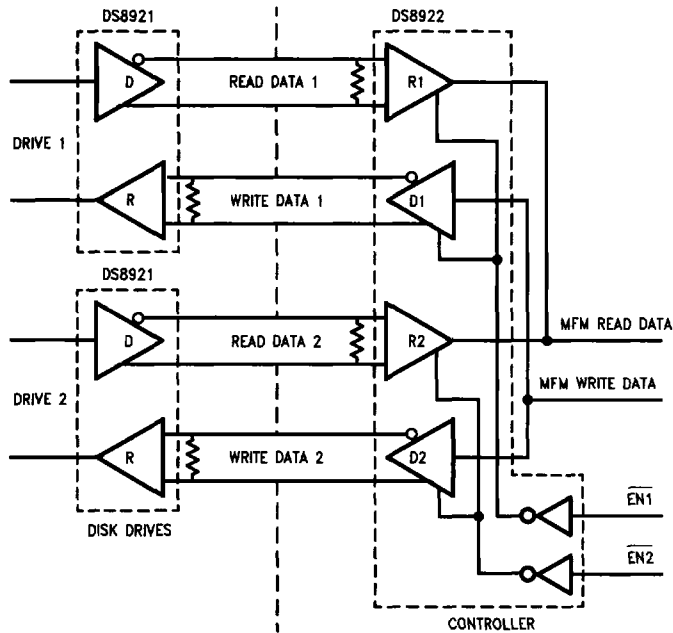

TL/F/8511-12