

## DS75150 Dual Line Driver

### General Description

The DS75150 is a dual monolithic line driver designed to satisfy the requirements of the standard interface between data terminal equipment and data communication equipment as defined by EIA Standard RS-232-C. A rate of 20,000 bits per second can be transmitted with a full 2500 pF load. Other applications are in data-transmission systems using relatively short single lines, in level translators, and for driving MOS devices. The logic input is compatible with most TTL and LS families. Operation is from  $-12\text{V}$  and  $+12\text{V}$  power supplies.

### Features

- Withstands sustained output short-circuit to any low impedance voltage between  $-25\text{V}$  and  $+25\text{V}$
- $2\ \mu\text{s}$  max transition time through the  $-3\text{V}$  to  $+3\text{V}$  transition region under full 2500 pF load
- Inputs compatible with most TTL and LS families
- Common strobe input
- Inverting output
- Slew rate can be controlled with an external capacitor at the output
- Standard supply voltages  $\pm 12\text{V}$

### Schematic and Connection Diagrams

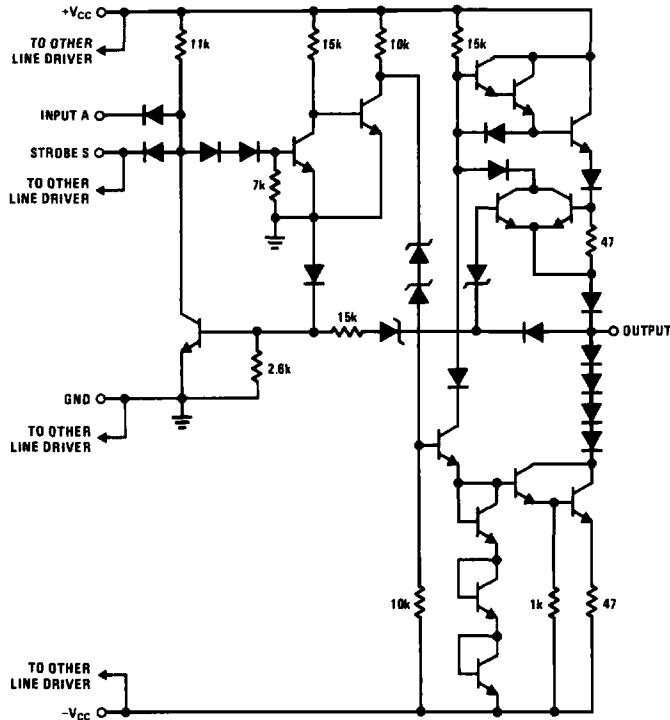

Component values shown are nominal.  
1/2 of circuit shown

TL/F/5794-1

### Dual-In-Line Package

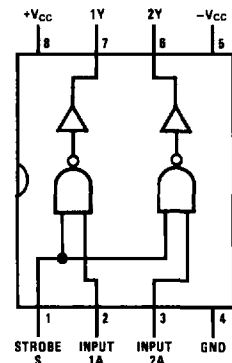

TL/F/5794-2

### Top View

Positive Logic C =  $\overline{AS}$

**Order Number**  
DS75150M or DS75150N  
**See NS Package Number**  
M08A or N08E

**Absolute Maximum Ratings** (Note 1)

If Military/Aerospace specified devices are required, please contact the National Semiconductor Sales Office/Distributors for availability and specifications.

Supply Voltage $+V_{CC}$	15V
Supply Voltage $-V_{CC}$	15V
Input Voltage	15V
Applied Output Voltage	+25V
Storage Temperature Range	-65°C to +150°C
Maximum Power Dissipation* at 25°C	
Molded DIP Package	1022 mW
SO Package	655 mW
Lead Temperature (Soldering, 4 sec.)	260°C

\*Derate molded DIP package 8.2 mW/°C above 25°C. Derate SO package 8.01 mW/°C above 25°C.

**Operating Conditions**

	Min	Max	Units
Supply Voltage ( $+V_{CC}$ )	10.8	13.2	V
Supply Voltage ( $-V_{CC}$ )	-10.8	-13.2	V
Input Voltage ( $V_I$ )	0	+5.5	V
Output Voltage ( $V_O$ )		±15	V
Operating Ambient Temperature Range ( $T_A$ )	0	+70	°C

**DC Electrical Characteristics** (Notes 2, 3, 4 and 5)

Symbol	Parameter	Conditions	Min	Typ	Max	Units
$V_{IH}$	High-Level Input Voltage	(Figure 1)	2			V
$V_{IL}$	Low-Level Input Voltage	(Figure 2)			0.8	V
$V_{OH}$	High-Level Output Voltage	$+V_{CC} = 10.8V, -V_{CC} = -13.2V, V_{IL} = 0.8V, R_L = 3\text{ k}\Omega$ to $7\text{ k}\Omega$ (Figure 2)	5	8		V
$V_{OL}$	Low-Level Output Voltage	$+V_{CC} = 10.8V, -V_{CC} = -10.8V, V_{IH} = 2V, R_L = 3\text{ k}\Omega$ to $7\text{ k}\Omega$ (Figure 1)		-8	-5	V
$I_{IH}$	High-Level Input Current	$+V_{CC} = 13.2V, -V_{CC} = -13.2V, V_I = 2.4V$ , (Figure 3) Data Input		1	10	$\mu\text{A}$
		$+V_{CC} = 13.2V, -V_{CC} = -13.2V, V_I = 2.4V$ , (Figure 3) Strobe Input		2	20	$\mu\text{A}$
$I_{IL}$	Low-Level Input Current	$+V_{CC} = 13.2V, -V_{CC} = -13.2V, V_I = 0.4V$ , (Figure 3) Data Input		-1	-1.6	mA
		$+V_{CC} = 13.2V, -V_{CC} = -13.2V, V_I = 0.4V$ , (Figure 3) Strobe Input		-2	-3.2	mA
$I_{OS}$	Short-Circuit Output Current	$+V_{CC} = 13.2V, -V_{CC} = -13.2V$ , (Figure 4), (Note 4) $V_O = 25V$		2	5	mA
		$V_O = -25V$		-3	-6	mA
		$V_O = 0V, V_I = 3V$		15	30	mA
		$V_O = 0V, V_I = 0V$		-15	-30	mA
$+I_{OCH}$	Supply Current From $+V_{CC}$ , High-Level Output	$+V_{CC} = 13.2V, -V_{CC} = -13.2V, V_I = 0V, R_L = 3\text{ k}\Omega, T_A = 25^\circ\text{C}$ , (Figure 5)		10	22	mA
$-I_{OCH}$	Supply Current From $-V_{CC}$ , High-Level Output	$+V_{CC} = 13.2V, -V_{CC} = -13.2V, V_I = 0V, R_L = 3\text{ k}\Omega, T_A = 25^\circ\text{C}$ , (Figure 5)		-1	-10	mA
$+I_{OCL}$	Supply Current From $+V_{CC}$ , Low-Level Output	$+V_{CC} = 13.2V, -V_{CC} = -13.2V, V_I = 3V, R_L = 3\text{ k}\Omega, T_A = 25^\circ\text{C}$ , (Figure 5)		8	17	mA
$-I_{OCL}$	Supply Current From $-V_{CC}$ , Low-Level Output	$+V_{CC} = 13.2V, -V_{CC} = -13.2V, V_I = 3V, R_L = 3\text{ k}\Omega, T_A = 25^\circ\text{C}$ , (Figure 5)		-9	-20	mA

**Note 1:** "Absolute Maximum Ratings" are those values beyond which the safety of the device cannot be guaranteed. Except for "Operating Temperature Range" they are not meant to imply that the devices should be operated at these limits. The table of "Electrical Characteristics" provides conditions for actual device operation.

**Note 2:** Unless otherwise specified min/max limits apply across the 0°C to +70°C range for the DS75150. All typical values are  $T_A = 25^\circ\text{C}$  and  $+V_{CC} = 12V, -V_{CC} = -12V$ .

**Note 3:** All current into device pins shown as positive, out of device pins as negative, all voltages referenced to ground unless otherwise noted. All values shown as max or min on absolute value basis.

**Note 4:** Only one output at a time should be shorted.

**Note 5:** The algebraic convention where the most-positive (least-negative) limit is designated as maximum is used in this data sheet for logic levels only, e.g., when -5V is the maximum, the typical value is more-negative voltage.

## AC Electrical Characteristics (+V<sub>CC</sub> = 12V, -V<sub>CC</sub> = -12V, T<sub>A</sub> = 25°C)

Symbol	Parameter	Conditions	Min	Typ	Max	Units
t <sub>TLH</sub>	Transition Time, Low-to-High Level Output	C <sub>L</sub> = 2500 pF, R <sub>L</sub> = 3 kΩ to 7 kΩ, (Figure 6)	0.2	1.4	2	μs
t <sub>THL</sub>	Transition Time, High-to-Low Level Output	C <sub>L</sub> = 2500 pF, R <sub>L</sub> = 3 kΩ to 7 kΩ, (Figure 6)	0.2	1.5	2	μs
t <sub>TLH</sub>	Transition Time, Low-to-High Level Output	C <sub>L</sub> = 15 pF, R <sub>L</sub> = 7 kΩ, (Figure 6)		40		ns
t <sub>THL</sub>	Transition Time, High-to-Low Level Output	C <sub>L</sub> = 15 pF, R <sub>L</sub> = 7 kΩ, (Figure 6)		20		ns
t <sub>PLH</sub>	Propagation Delay Time Low-to-High Level Output	C <sub>L</sub> = 15 pF, R <sub>L</sub> = 7 kΩ, (Figure 6)		60		ns
t <sub>PHL</sub>	Propagation Delay Time High-to-Low Level Output	C <sub>L</sub> = 15 pF, R <sub>L</sub> = 7 kΩ, (Figure 6)		45		ns

## DC Test Circuits

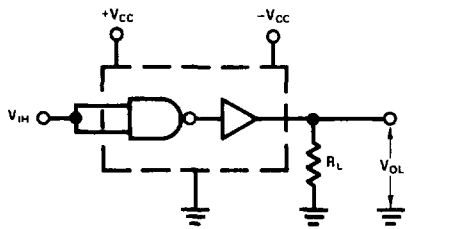
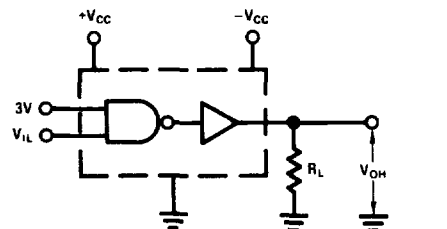

FIGURE 1. V<sub>IH</sub>, V<sub>OL</sub>

TL/F/5794-3



Each input is tested separately.

FIGURE 2. V<sub>IL</sub>, V<sub>OH</sub>

TL/F/5794-4

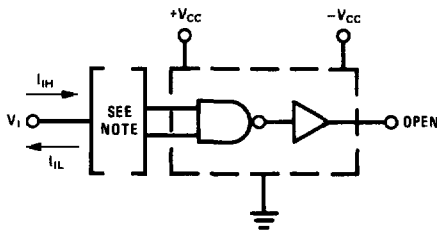

TL/F/5794-5

**Note:** When testing I<sub>IH</sub>, the other input is at 3V; when testing I<sub>IL</sub>, the other input is open.

FIGURE 3. I<sub>IH</sub>, I<sub>IL</sub>

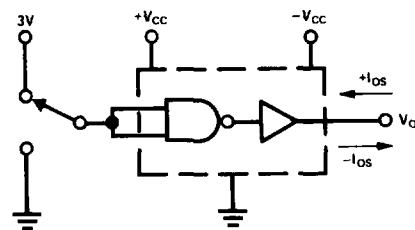

TL/F/5794-6

I<sub>OS</sub> is tested for both input conditions at each of the specified output conditions.

FIGURE 4. I<sub>OS</sub>

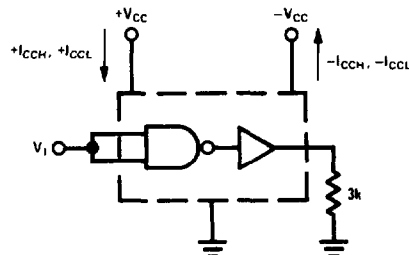
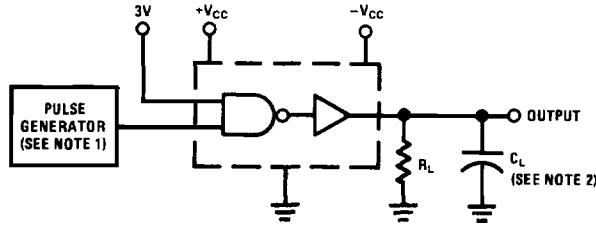

FIGURE 5. I<sub>CCH+</sub>, I<sub>CCH-</sub>, I<sub>CCL+</sub>, I<sub>CCL-</sub>

TL/F/5794-7

### AC Test Circuit and Switching Waveforms



TL/F/5794-8

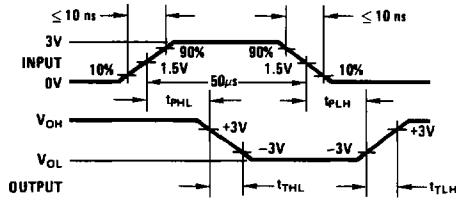

TL/F/5794-9

**Note 1:** The pulse generator has the following characteristics:  
duty cycle ≤ 50%, Z<sub>OUT</sub> ≈ 50 Ω.

**Note 2:** C<sub>L</sub> includes probe and jig capacitance.

FIGURE 6

### Typical Performance Characteristics

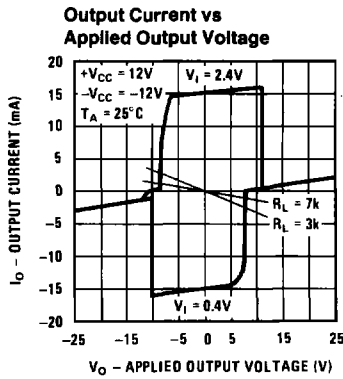

TL/F/5794-10

FIGURE 7