

OPA859 1.8 GHz Unity-Gain Bandwidth, 3.3-nV/ $\sqrt{\text{Hz}}$, FET Input Amplifier

1 Features

- High Unity-Gain Bandwidth: 1.8 GHz
- Gain Bandwidth Product: 900 MHz
- Ultra-Low Bias Current MOSFET Inputs: 10 pA
- Low Input Voltage Noise: 3.3 nV/ $\sqrt{\text{Hz}}$
- Slew Rate: 1150 V/ μs
- Low Input Capacitance:
 - Common-Mode: 0.6 pF
 - Differential: 0.2 pF
- Wide Input Common-Mode Range:
 - 1.4 V from Positive Supply
 - Includes Negative Supply
- 2.5 V_{PP} Output Swing in TIA Configuration
- Supply Voltage Range: 3.3 V to 5.25 V
- Quiescent Current: 20.5 mA
- Package: 8-Pin WSON
- Temperature Range: –40 to +125°C

2 Applications

- High-Speed Transimpedance Amplifier
- Laser Distance Measurement
- CCD Output Buffer
- High-Speed Buffer
- Optical Time Domain Reflectometry (OTDR)
- High-Speed Active Filter
- 3D Scanner
- Silicon Photomultiplier (SiPM) Buffer Amplifier
- Photomultiplier Tube Post Amplifier

3 Description

The OPA859 is a wideband, low-noise operational amplifier with CMOS inputs for wideband transimpedance and voltage amplifier applications. When the device is configured as a transimpedance amplifier (TIA), the 0.9-GHz gain bandwidth product (GBWP) enables high closed-loop bandwidths in low-capacitance photodiode applications.

The graph below shows the bandwidth and noise performance of the OPA859 as a function of the photodiode capacitance when the amplifier is set as a TIA. The total noise is calculated along a bandwidth range extending from dc to the calculated frequency, f , on the left-hand scale. The OPA859 package has a feedback pin (FB) that simplifies the feedback network connection between the input and the output.

The OPA859 is optimized to operate in optical time-of-flight (ToF) systems where the OPA859 is used with time-to-digital converters, such as the [TDC7201](#). Use the OPA859 to drive a high-speed analog-to-digital converter (ADC) in high-resolution LIDAR systems with a differential output amplifier, such as the [THS4541](#) or [LMH5401](#).

Device Information⁽¹⁾

PART NUMBER	PACKAGE	BODY SIZE (NOM)
OPA859	WSON (8)	2.00 mm x 2.00 mm

(1) For all available packages, see the package option addendum at the end of the data sheet.

High-Speed Time-of-Flight Receiver

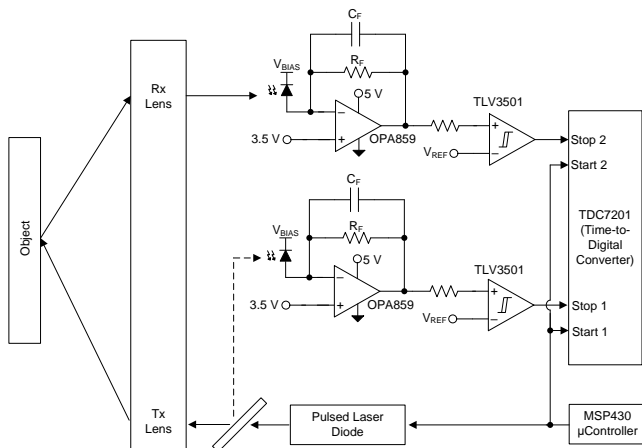

Photodiode Capacitance vs Bandwidth and Noise

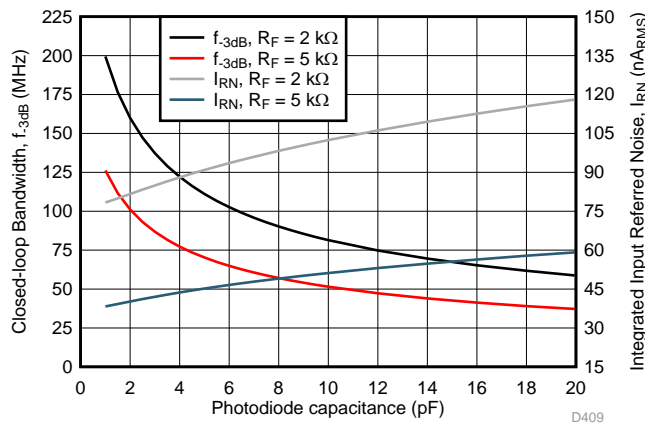

D409



Table of Contents

1 Features	1	9.3 Feature Description.....	16
2 Applications	1	9.4 Device Functional Modes.....	19
3 Description	1	10 Application and Implementation	20
4 Revision History	2	10.1 Application Information.....	20
5 Device Comparison Table	3	10.2 Typical Application	21
6 Pin Configuration and Functions	3	11 Power Supply Recommendations	23
7 Specifications	4	12 Layout	24
7.1 Absolute Maximum Ratings	4	12.1 Layout Guidelines	24
7.2 ESD Ratings.....	4	12.2 Layout Example	24
7.3 Recommended Operating Conditions.....	4	13 Device and Documentation Support	25
7.4 Thermal Information	4	13.1 Device Support.....	25
7.5 Electrical Characteristics	5	13.2 Documentation Support	25
7.6 Typical Characteristics.....	7	13.3 Receiving Notification of Documentation Updates	25
8 Parameter Measurement Information	14	13.4 Community Resources.....	25
8.1 Parameter Measurement Information	14	13.5 Trademarks	25
9 Detailed Description	15	13.6 Electrostatic Discharge Caution.....	25
9.1 Overview	15	13.7 Glossary	25
9.2 Functional Block Diagram	15	14 Mechanical, Packaging, and Orderable Information	26

4 Revision History

DATE	REVISION	NOTES
September 2018	*	Initial release.

5 Device Comparison Table

DEVICE	INPUT TYPE	MINIMUM STABLE GAIN	VOLTAGE NOISE (nV/√Hz)	INPUT CAPACITANCE (pF)	GAIN BANDWIDTH (GHz)
OPA859	CMOS	1 V/V	3.3	0.8	0.9
OPA858	CMOS	7 V/V	2.5	0.8	5.5
OPA855	Bipolar	7 V/V	0.98	0.8	8
LMH6629	Bipolar	10 V/V	0.69	5.7	4

6 Pin Configuration and Functions

DSG Package
8-Pin WSON With Exposed Thermal Pad
Top View

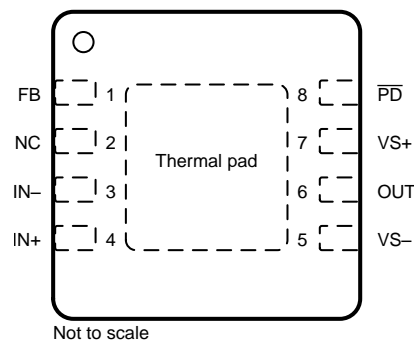

Pin Functions

PIN		I/O	DESCRIPTION
NAME	NO.		
FB	1	I	Feedback connection to output of amplifier
IN-	3	I	Inverting input
IN+	4	I	Noninverting input
NC	2	—	Do not connect
OUT	6	O	Amplifier output
$\overline{\text{PD}}$	8	I	Power down connection. $\overline{\text{PD}}$ = logic low = power off mode; PD = logic high = normal operation.
VS-	5	—	Negative voltage supply
VS+	7	—	Positive voltage supply
Thermal pad		—	Connect the thermal pad to VS-

7 Specifications

7.1 Absolute Maximum Ratings

over operating free-air temperature range (unless otherwise noted)⁽¹⁾

		MIN	MAX	UNIT
V_S	Total supply voltage ($V_{S+} - V_{S-}$)		5.5	V
V_{IN+}, V_{IN-}	Input voltage	$(V_{S-}) - 0.5$	$(V_{S+}) + 0.5$	V
V_{ID}	Differential input voltage		1	V
V_{OUT}	Output voltage	$(V_{S-}) - 0.5$	$(V_{S+}) + 0.5$	V
I_{IN}	Continuous input current		±10	mA
I_{OUT}	Continuous output current ⁽²⁾		±100	mA
T_J	Junction temperature		150	°C
T_A	Operating free-air temperature	-40	125	°C
T_{stg}	Storage temperature	-65	150	°C

- (1) Stresses beyond those listed under *Absolute Maximum Ratings* may cause permanent damage to the device. These are stress ratings only, which do not imply functional operation of the device at these or any other conditions beyond those indicated under *Recommended Operating Conditions*. Exposure to absolute-maximum-rated conditions for extended periods may affect device reliability.
- (2) Long-term continuous output current for electromigration limits.

7.2 ESD Ratings

			VALUE	UNIT
$V_{(ESD)}$	Electrostatic discharge	Human-body model (HBM), per ANSI/ESDA/JEDEC JS-001 ⁽¹⁾	±1000	V
		Charged-device model (CDM), per JEDEC specification JESD22-C101 ⁽²⁾	±1500	

- (1) JEDEC document JEP155 states that 500-V HBM allows safe manufacturing with a standard ESD control process.
- (2) JEDEC document JEP157 states that 250-V CDM allows safe manufacturing with a standard ESD control process.

7.3 Recommended Operating Conditions

over operating free-air temperature range (unless otherwise noted)

		MIN	NOM	MAX	UNIT
V_S	Total supply voltage ($V_{S+} - V_{S-}$)	3.3	5	5.25	V
T_A	Operating free-air temperature	-40		125	°C

7.4 Thermal Information

THERMAL METRIC ⁽¹⁾		OPA859	UNIT
		DSG (WSON)	
		8 PINS	
$R_{\theta JA}$	Junction-to-ambient thermal resistance	80.1	°C/W
$R_{\theta JC(top)}$	Junction-to-case (top) thermal resistance	100	°C/W
$R_{\theta JB}$	Junction-to-board thermal resistance	45	°C/W
Ψ_{JT}	Junction-to-top characterization parameter	6.8	°C/W
Ψ_{JB}	Junction-to-board characterization parameter	45.2	°C/W
$R_{\theta JC(bot)}$	Junction-to-case (bottom) thermal resistance	22.7	°C/W

- (1) For more information about traditional and new thermal metrics, see the [Semiconductor and IC Package Thermal Metrics application report](#).

7.5 Electrical Characteristics

$V_{S+} = 5\text{ V}$, $V_{S-} = 0\text{ V}$, input common-mode biased at midsupply, unity gain configuration, $R_L = 200\ \Omega$, output load is referenced to midsupply, and $T_A \approx +25^\circ\text{C}$ (unless otherwise noted)

PARAMETER		TEST CONDITIONS	MIN	TYP	MAX	UNIT
AC PERFORMANCE						
SSBW	Small-signal bandwidth	$V_{OUT} = 100\text{ mV}_{PP}$		1.8		GHz
LSBW	Large-signal bandwidth	$V_{OUT} = 2\text{ V}_{PP}$		400		MHz
GBWP	Gain-bandwidth product			900		MHz
	Bandwidth for 0.1dB flatness			140		MHz
SR	Slew rate (10% - 90%)	$V_{OUT} = 2\text{-V step}$		1150		V/ μs
t_r	Rise time	$V_{OUT} = 100\text{-mV step}$		0.3		ns
t_f	Fall time	$V_{OUT} = 100\text{-mV step}$		0.3		ns
	Settling time to 0.1%	$V_{OUT} = 2\text{-V step}$		8		ns
	Settling time to 0.001%	$V_{OUT} = 2\text{-V step}$		3000		ns
	Overshoot/undershoot	$V_{OUT} = 2\text{-V step}$		7%		
HD2	Second-order harmonic distortion	$f = 10\text{ MHz}$, $V_{OUT} = 2\text{ V}_{PP}$		90		dBc
		$f = 100\text{ MHz}$, $V_{OUT} = 2\text{ V}_{PP}$		60		
HD3	Third-order harmonic distortion	$f = 10\text{ MHz}$, $V_{OUT} = 2\text{ V}_{PP}$		86		dBc
		$f = 100\text{ MHz}$, $V_{OUT} = 2\text{ V}_{PP}$		64		
e_n	Input-referred voltage noise	$f = 1\text{ MHz}$		3.3		nV/ $\sqrt{\text{Hz}}$
Z_{OUT}	Closed-loop output impedance	$f = 1\text{ MHz}$		0.15		Ω
DC PERFORMANCE						
A_{OL}	Open-loop voltage gain		60	65		dB
V_{OS}	Input offset voltage	$T_A = 25^\circ\text{C}$	-5	± 0.9	5	mV
$\Delta V_{OS}/\Delta T$	Input offset voltage drift	$T_A = -40^\circ\text{C}$ to $+125^\circ\text{C}$		-2		$\mu\text{V}/^\circ\text{C}$
I_{BN} , I_{BI}	Input bias current	$T_A = 25^\circ\text{C}$	-5	± 0.5	5	pA
I_{BOS}	Input offset current	$T_A = 25^\circ\text{C}$	-5	± 0.1	5	pA
CMRR	Common-mode rejection ratio	$V_{CM} = \pm 0.5\text{ V}$	70	84		dB
INPUT						
	Common-mode input resistance			1		G Ω
C_{CM}	Common-mode input capacitance			0.62		pF
	Differential input resistance			1		G Ω
C_{DIFF}	Differential input capacitance			0.2		pF
V_{IH}	Common-mode input range (high)	$V_{S+} = 3.3\text{ V}$, CMRR > 66 dB	1.7	1.9		V
V_{IL}	Common-mode input range (low)	$V_{S+} = 3.3\text{ V}$, CMRR > 66 dB		0	0.4	V
V_{IH}	Common-mode input range (high)	CMRR > 66 dB	3.4	3.6		V
		$T_A = -40^\circ\text{C}$ to $+125^\circ\text{C}$, CMRR > 66 dB		3.4		
V_{IL}	Common-mode input range (low)	CMRR > 66 dB		0	0.4	V
		$T_A = -40^\circ\text{C}$ to $+125^\circ\text{C}$, CMRR > 66 dB		0.35	0.45	
OUTPUT						
V_{OH}	Output voltage (high)	$V_{S+} = 3.3\text{ V}$, $T_A = 25^\circ\text{C}$	2.3	2.4		V
V_{OH}	Output voltage (high)	$T_A = 25^\circ\text{C}$	3.95	4.1		V
		$T_A = -40^\circ\text{C}$ to $+125^\circ\text{C}$		3.9		
V_{OL}	Output voltage (low)	$V_{S+} = 3.3\text{ V}$, $T_A = 25^\circ\text{C}$		1.05	1.15	V
V_{OL}	Output voltage (low)	$T_A = 25^\circ\text{C}$		1.1	1.15	V
		$T_A = -40^\circ\text{C}$ to $+125^\circ\text{C}$		1.2		
I_{O_LIN}	Linear output drive (sink and source)	$R_L = 10\ \Omega$, $A_{OL} > 52\text{ dB}$	65	76		mA
		$T_A = -40^\circ\text{C}$ to $+125^\circ\text{C}$, $R_L = 10\ \Omega$, $A_{OL} > 52\text{ dB}$		64		
I_{SC}	Output short-circuit current		85	105		mA

Electrical Characteristics (continued)

$V_{S+} = 5\text{ V}$, $V_{S-} = 0\text{ V}$, input common-mode biased at midsupply, unity gain configuration, $R_L = 200\ \Omega$, output load is referenced to midsupply, and $T_A \approx +25^\circ\text{C}$ (unless otherwise noted)

PARAMETER		TEST CONDITIONS	MIN	TYP	MAX	UNIT
POWER SUPPLY						
I_Q	Quiescent current	$V_{S+} = 5\text{ V}$	18	20.5	24	mA
		$V_{S+} = 3.3\text{ V}$	17.5	20	23.5	
		$V_{S+} = 5.25\text{ V}$	18	21	24	
		$T_A = 125^\circ\text{C}$		24.5		
		$T_A = -40^\circ\text{C}$		18.5		
PSRR+	Positive power-supply rejection ratio		66	74		dB
PSRR–	Negative power-supply rejection ratio		64	72		
POWER DOWN						
	Disable voltage threshold	Amplifier OFF below this voltage	0.65	1		V
	Enable voltage threshold	Amplifier ON above this voltage		1.5	1.8	V
	Power-down quiescent current			70	140	μA
	$\overline{\text{PD}}$ bias current			70	200	μA
	Turnon time delay	Time to $V_{\text{OUT}} = 90\%$ of final value		25		ns
	Turnoff time delay			120		ns

7.6 Typical Characteristics

at $T_A = 25^\circ\text{C}$, $V_{S+} = 2.5\text{ V}$, $V_{S-} = -2.5\text{ V}$, $V_{IN+} = 0\text{ V}$, Gain = 1 V/V, $R_F = 0\ \Omega$, $R_L = 200\ \Omega$, and output load referenced to midsupply (unless otherwise noted)

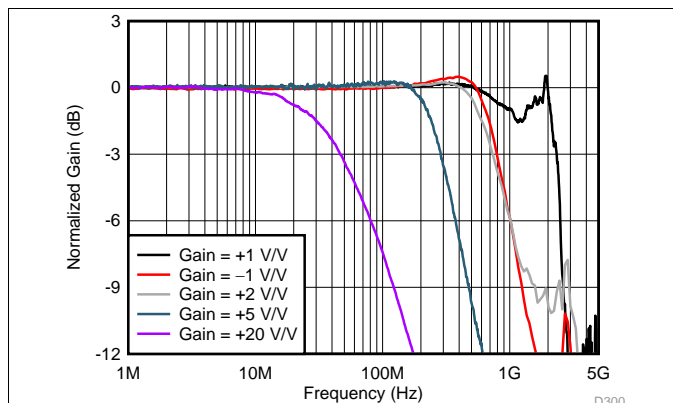

$V_{OUT} = 100\text{ mV}_{PP}$; see [Parameter Measurement Information](#) for circuit configuration

Figure 1. Small-Signal Frequency Response vs Gain

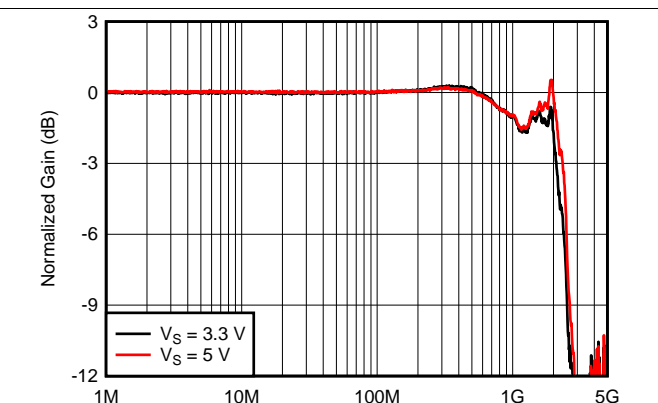

$V_{OUT} = 100\text{ mV}_{PP}$

Figure 2. Small-Signal Frequency Response vs Supply Voltage

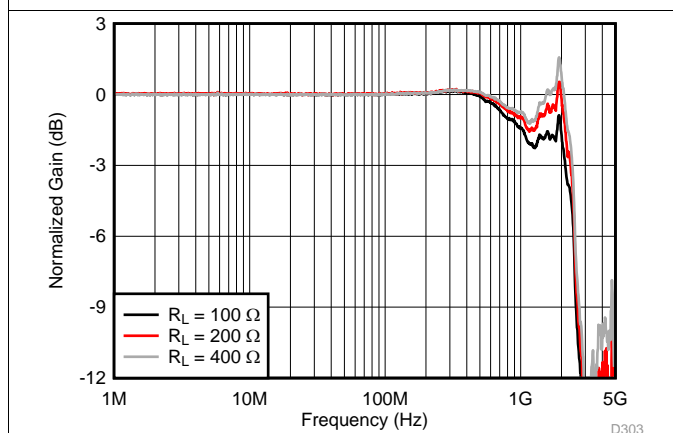

$V_{OUT} = 100\text{ mV}_{PP}$

Figure 3. Small-Signal Frequency Response vs Output Load

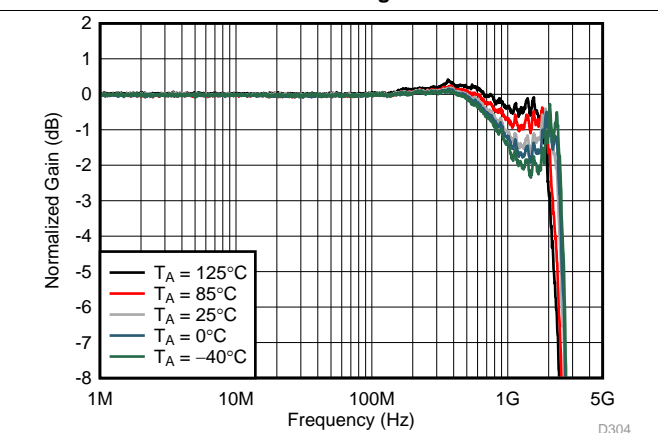

$V_{OUT} = 100\text{ mV}_{PP}$

Figure 4. Small-Signal Frequency Response vs Ambient Temperature

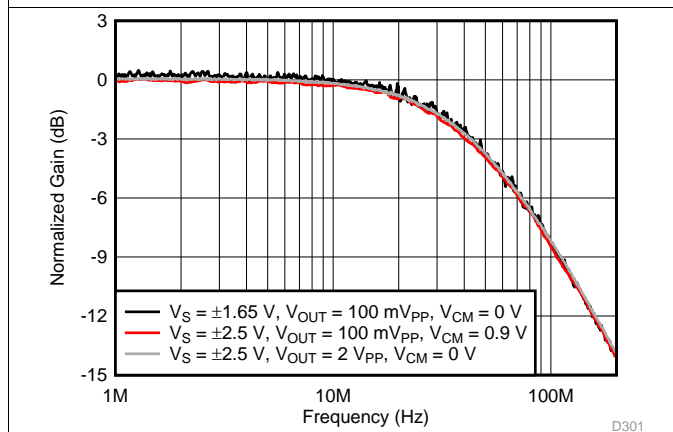

Gain = 20 V/V

$R_F = 453\ \Omega$

Figure 5. Frequency Response at Gain = 20 V/V

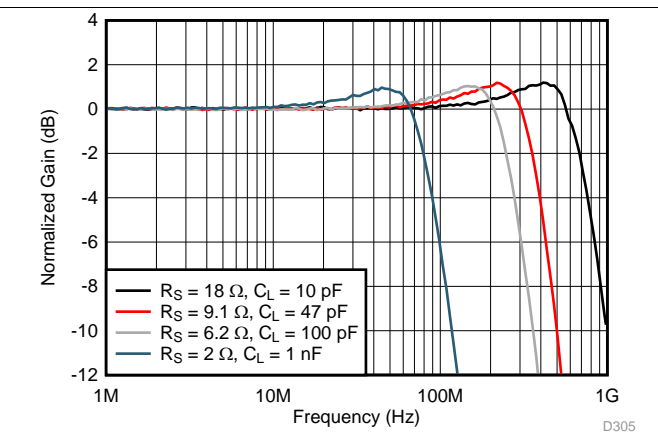

$V_{OUT} = 100\text{ mV}_{PP}$, See [Figure 46](#) for circuit configuration

Figure 6. Small-Signal Frequency Response vs Capacitive Load

Typical Characteristics (continued)

at $T_A = 25^\circ\text{C}$, $V_{S+} = 2.5\text{ V}$, $V_{S-} = -2.5\text{ V}$, $V_{IN+} = 0\text{ V}$, Gain = 1 V/V, $R_F = 0\ \Omega$, $R_L = 200\ \Omega$, and output load referenced to midsupply (unless otherwise noted)

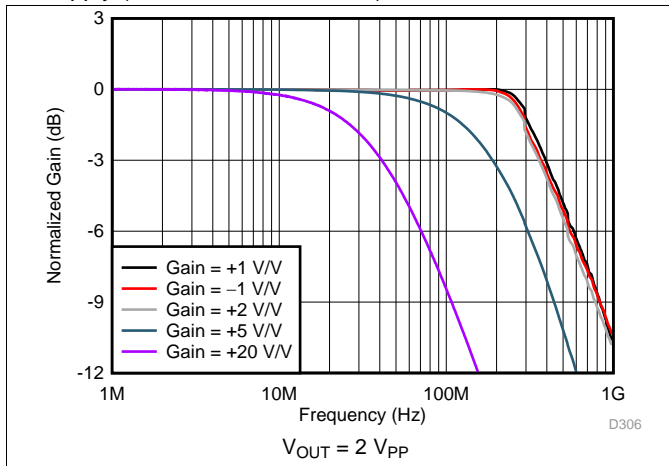

Figure 7. Large-Signal Frequency Response vs Gain

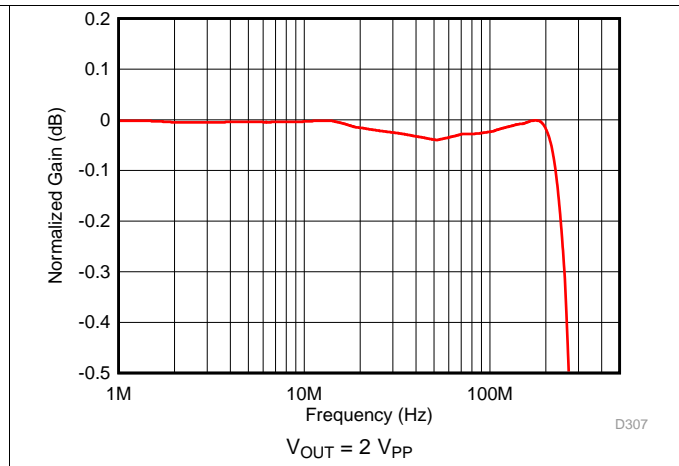

Figure 8. Large-Signal Response for 0.1-dB Gain Flatness

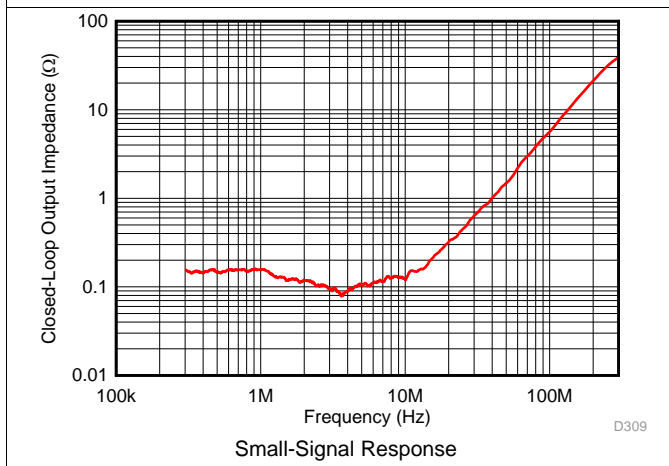

Figure 9. Closed-Loop Output Impedance vs Frequency

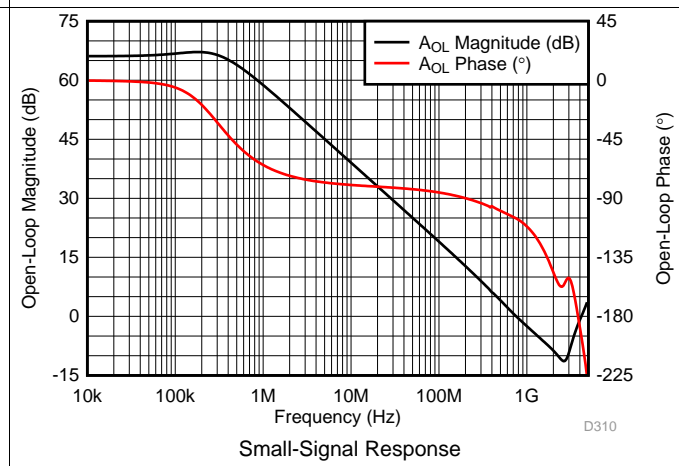

Figure 10. Open-Loop Magnitude and Phase vs Frequency

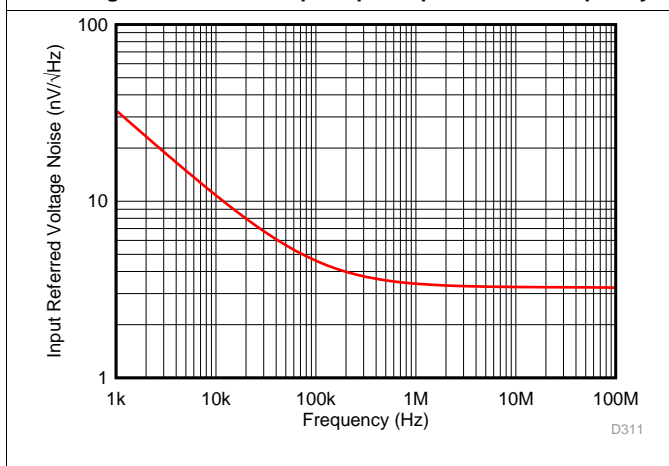

Figure 11. Voltage Noise Density vs Frequency

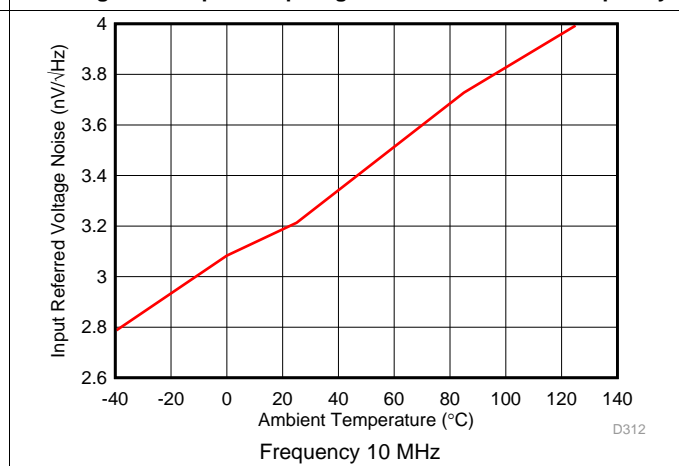

Figure 12. Voltage Noise Density vs Ambient Temperature

Typical Characteristics (continued)

at $T_A = 25^\circ\text{C}$, $V_{S+} = 2.5\text{ V}$, $V_{S-} = -2.5\text{ V}$, $V_{IN+} = 0\text{ V}$, Gain = 1 V/V, $R_F = 0\ \Omega$, $R_L = 200\ \Omega$, and output load referenced to midsupply (unless otherwise noted)

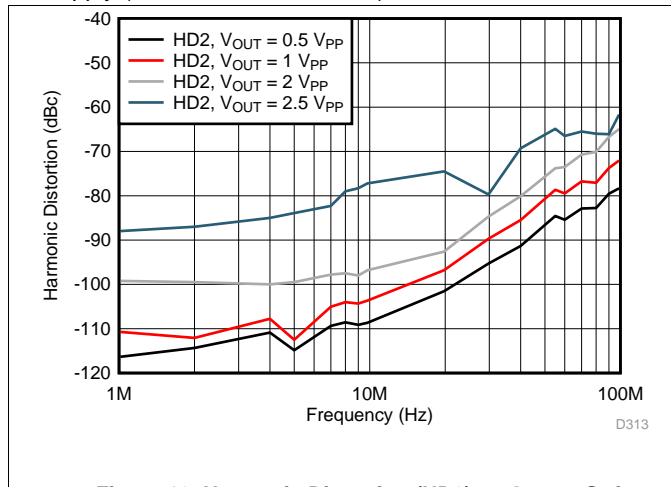

Figure 13. Harmonic Distortion (HD2) vs Output Swing

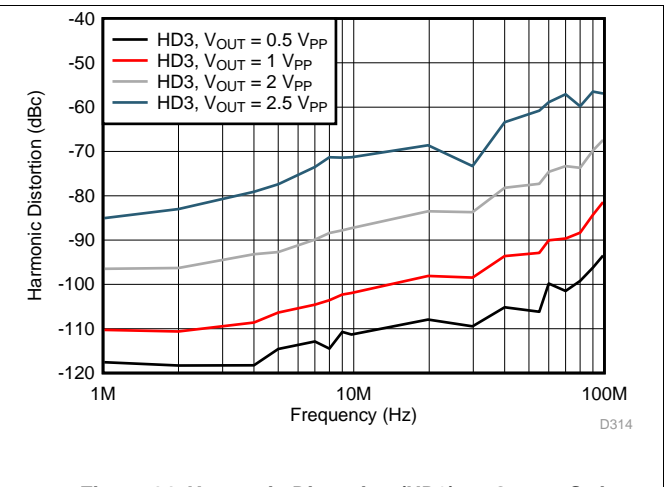

Figure 14. Harmonic Distortion (HD3) vs Output Swing

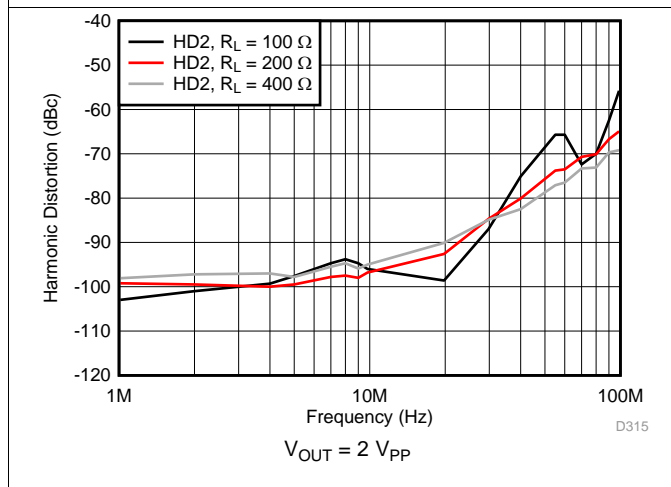

Figure 15. Harmonic Distortion (HD2) vs Output Load

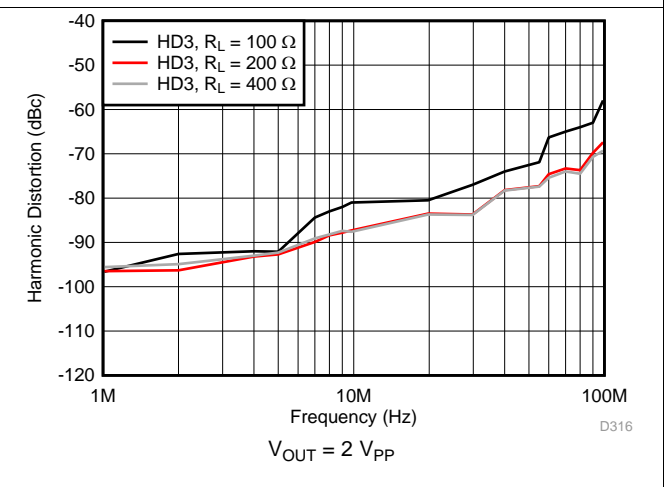

Figure 16. Harmonic Distortion (HD3) vs Output Load

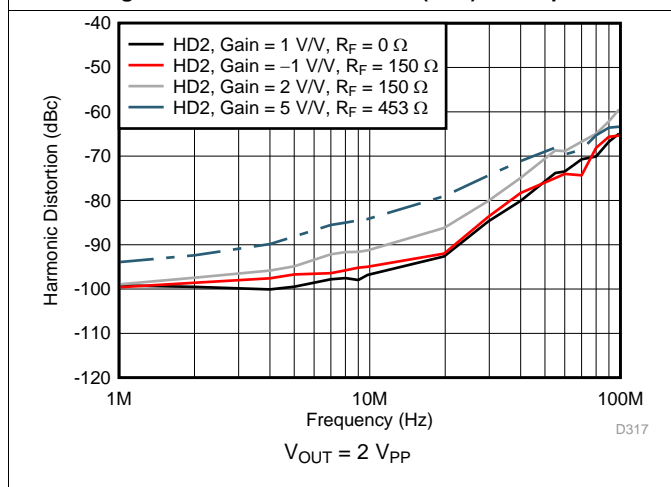

Figure 17. Harmonic Distortion (HD2) vs Gain

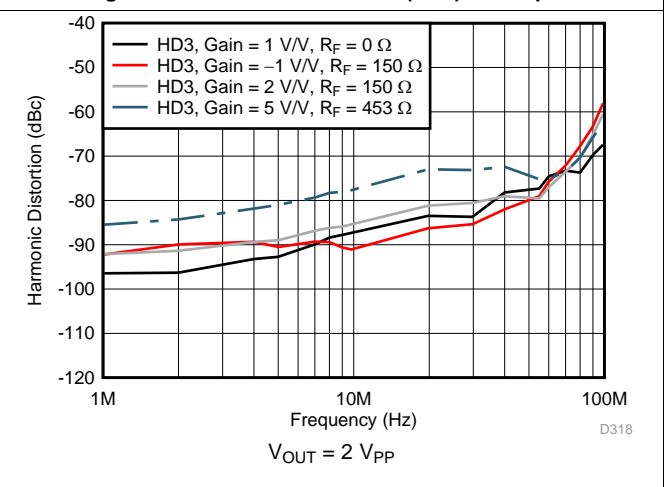

Figure 18. Harmonic Distortion (HD3) vs Gain

Typical Characteristics (continued)

at $T_A = 25^\circ\text{C}$, $V_{S+} = 2.5\text{ V}$, $V_{S-} = -2.5\text{ V}$, $V_{IN+} = 0\text{ V}$, Gain = 1 V/V, $R_F = 0\ \Omega$, $R_L = 200\ \Omega$, and output load referenced to midsupply (unless otherwise noted)

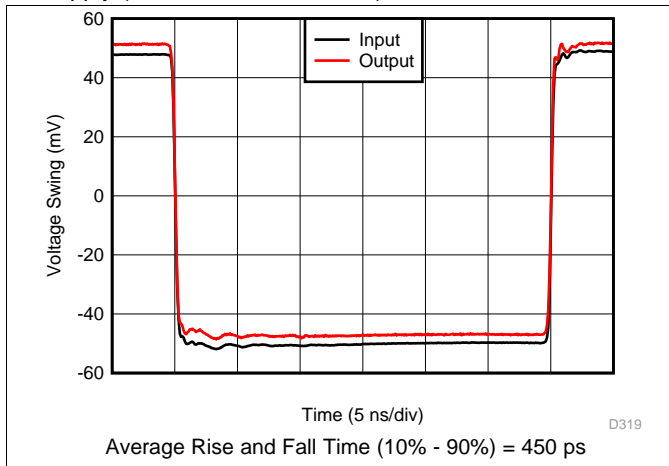

Figure 19. Small-Signal Transient Response

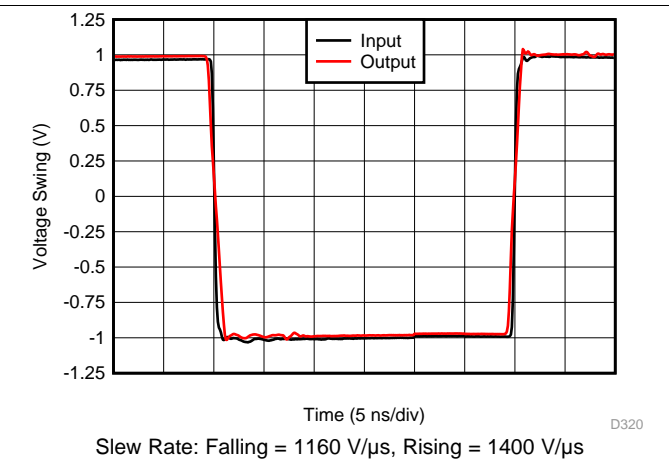

Figure 20. Large-Signal Transient Response

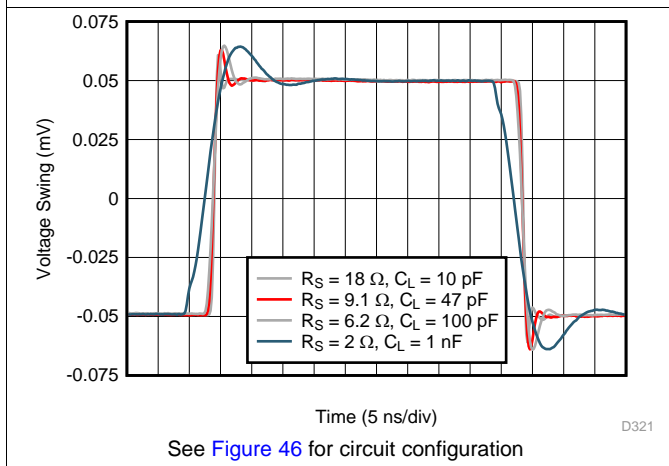

Figure 21. Small-Signal Transient Response vs Capacitive Load

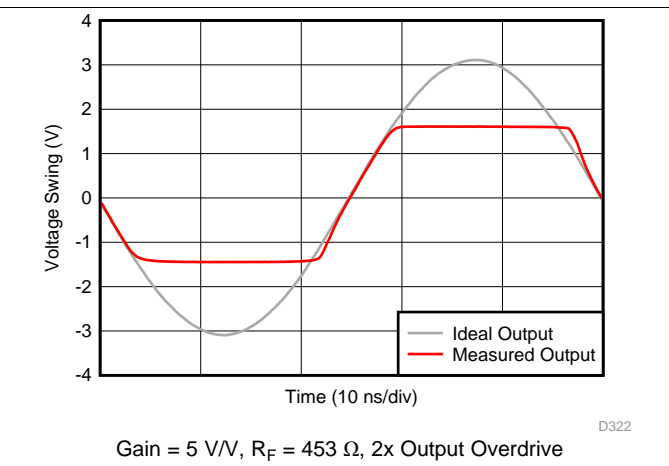

Figure 22. Output Overload Response

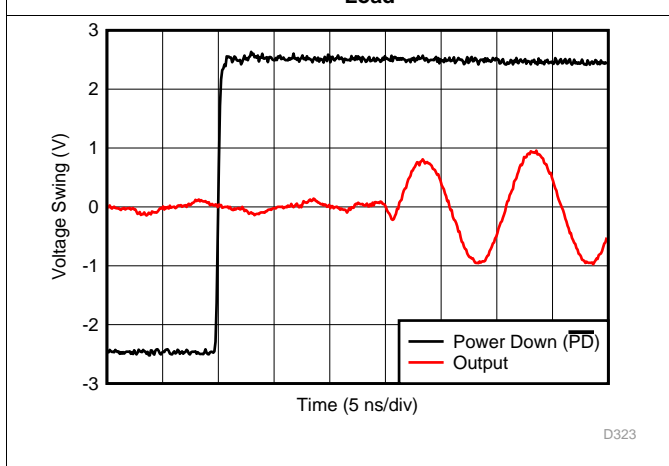

Figure 23. Turnon Transient Response

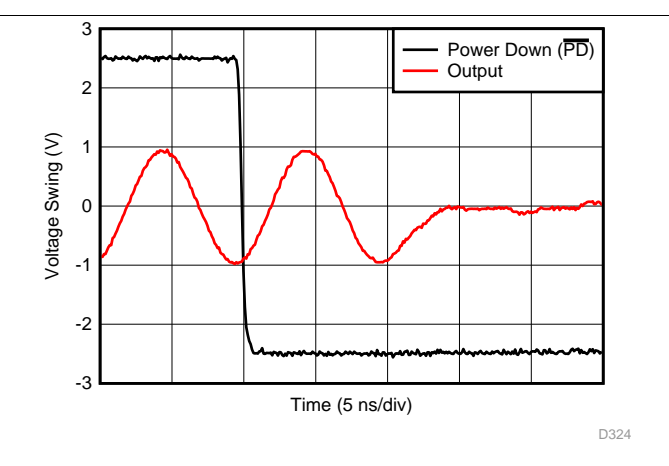

Figure 24. Turnoff Transient Response

Typical Characteristics (continued)

at $T_A = 25^\circ\text{C}$, $V_{S+} = 2.5\text{ V}$, $V_{S-} = -2.5\text{ V}$, $V_{IN+} = 0\text{ V}$, Gain = 1 V/V, $R_F = 0\ \Omega$, $R_L = 200\ \Omega$, and output load referenced to midsupply (unless otherwise noted)

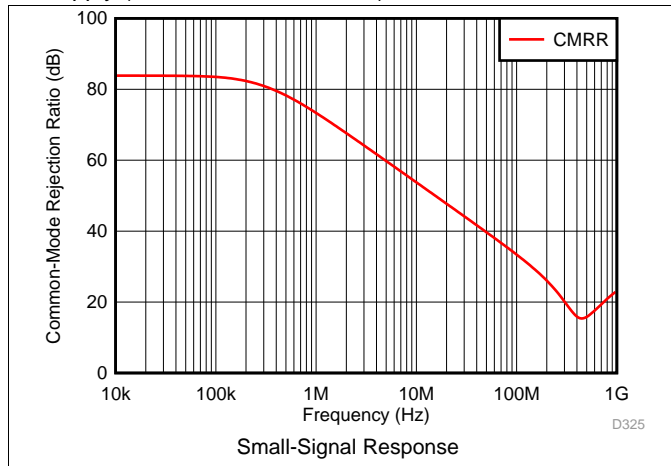

Figure 25. Common-Mode Rejection Ratio vs Frequency

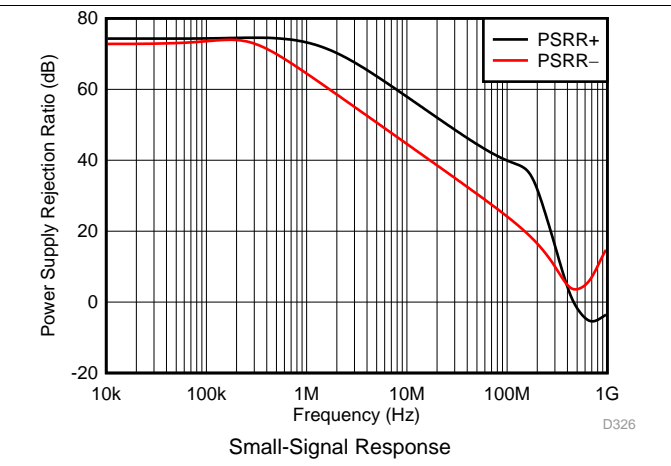

Figure 26. Power Supply Rejection Ratio vs Frequency

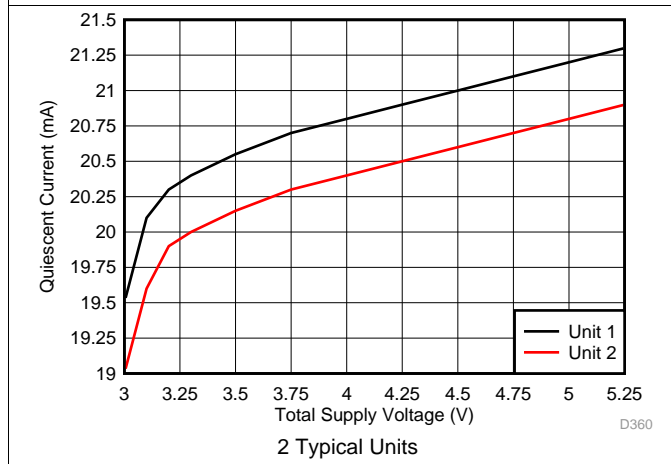

Figure 27. Quiescent Current vs Supply Voltage

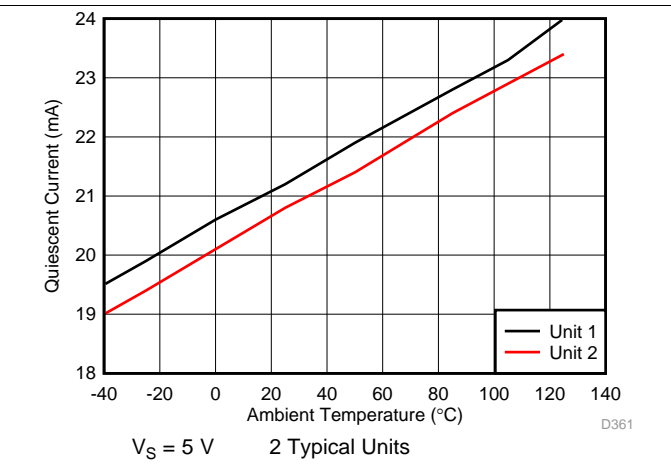

Figure 28. Quiescent Current vs Ambient Temperature

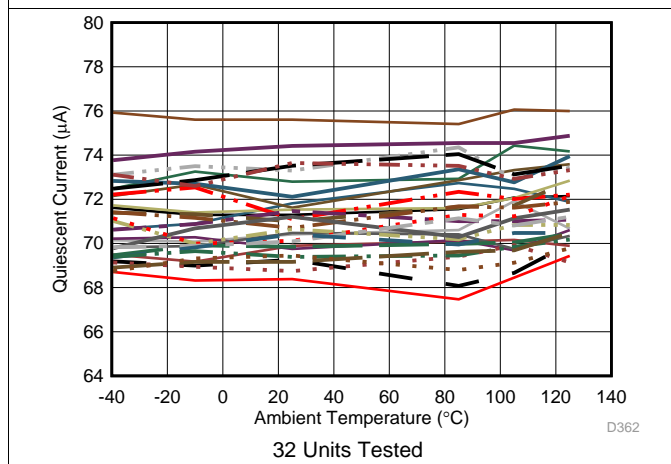

Figure 29. Quiescent Current (Amplifier Disabled) vs Ambient Temperature

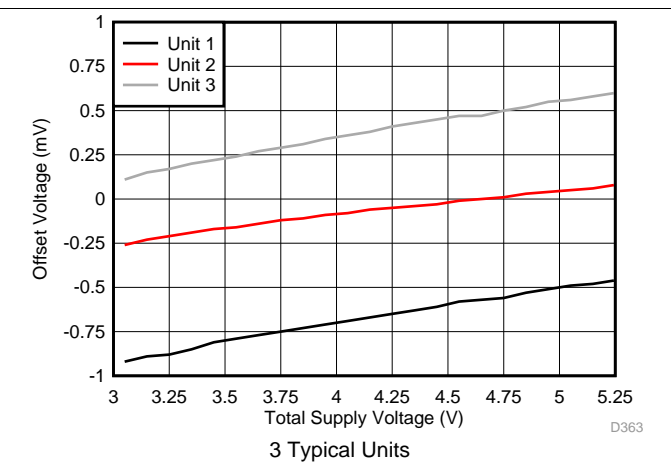

Figure 30. Offset Voltage vs Supply Voltage

Typical Characteristics (continued)

at $T_A = 25^\circ\text{C}$, $V_{S+} = 2.5\text{ V}$, $V_{S-} = -2.5\text{ V}$, $V_{IN+} = 0\text{ V}$, Gain = 1 V/V, $R_F = 0\ \Omega$, $R_L = 200\ \Omega$, and output load referenced to midsupply (unless otherwise noted)

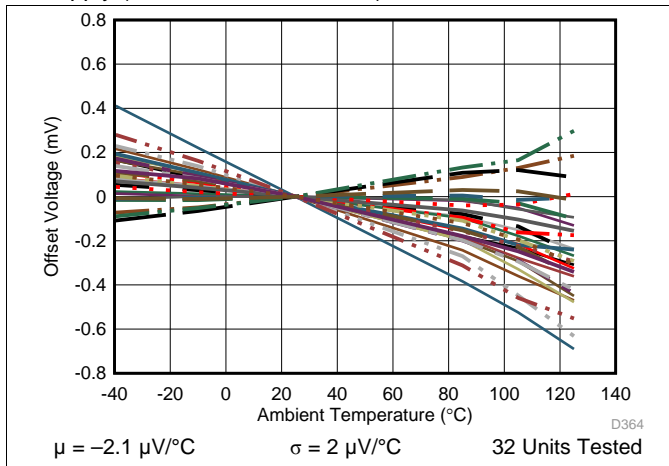

Figure 31. Offset Voltage vs Ambient Temperature

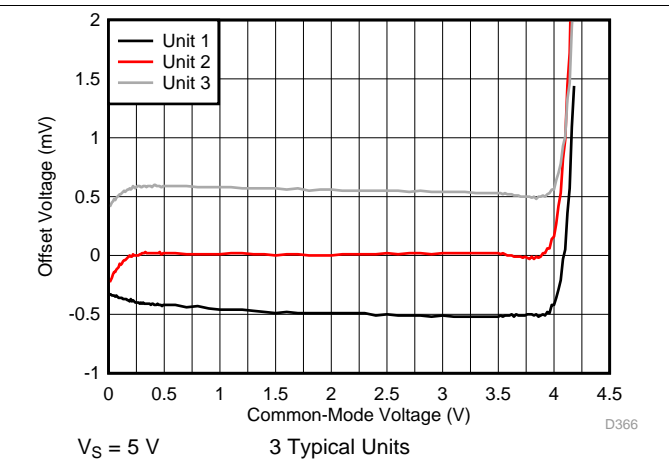

Figure 32. Offset Voltage vs Input Common-Mode Voltage

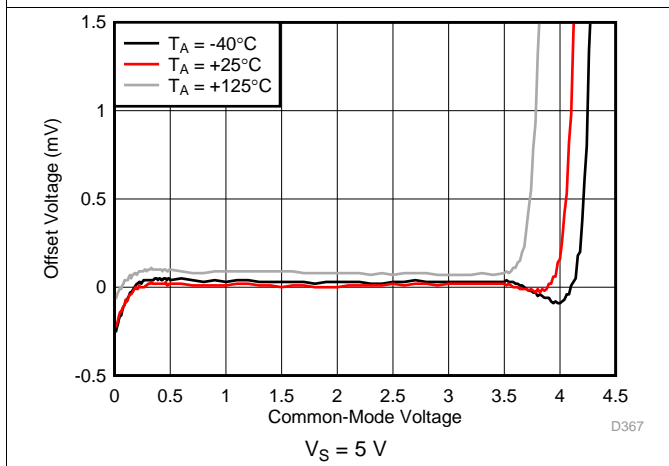

Figure 33. Offset Voltage vs Input Common-Mode Voltage vs Ambient Temperature

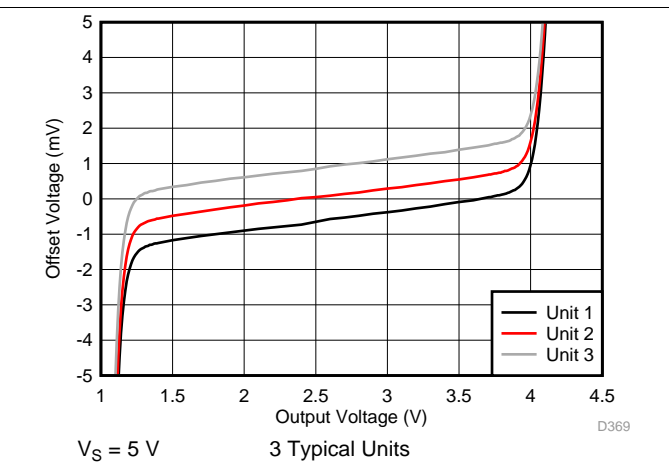

Figure 34. Offset Voltage vs Output Swing

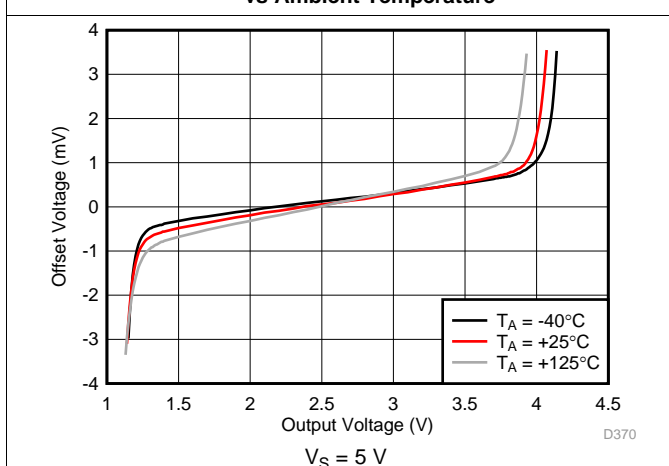

Figure 35. Offset Voltage vs Output Swing vs Ambient Temperature

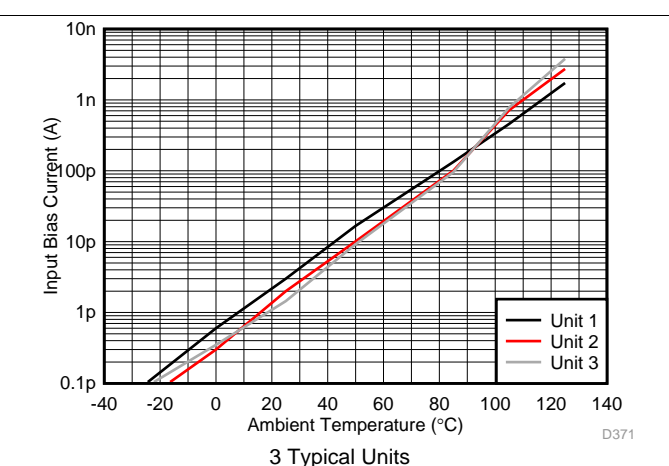

Figure 36. Input Bias Current vs Ambient Temperature

Typical Characteristics (continued)

at $T_A = 25^\circ\text{C}$, $V_{S+} = 2.5\text{ V}$, $V_{S-} = -2.5\text{ V}$, $V_{IN+} = 0\text{ V}$, Gain = 1 V/V, $R_F = 0\ \Omega$, $R_L = 200\ \Omega$, and output load referenced to midsupply (unless otherwise noted)

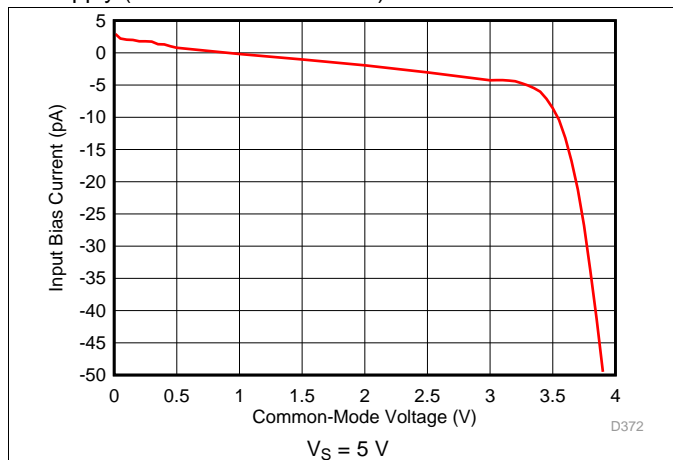

Figure 37. Input Bias Current vs Input Common-Mode Voltage

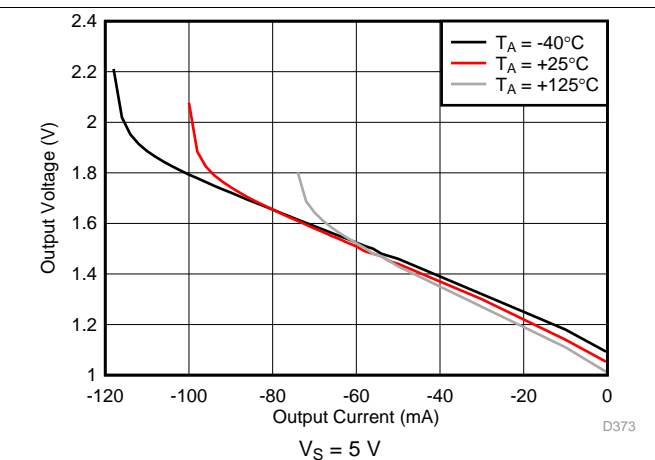

Figure 38. Output Swing vs Sinking Current

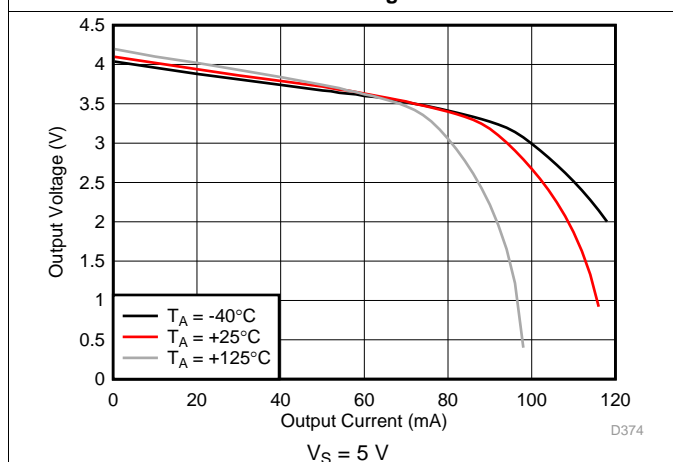
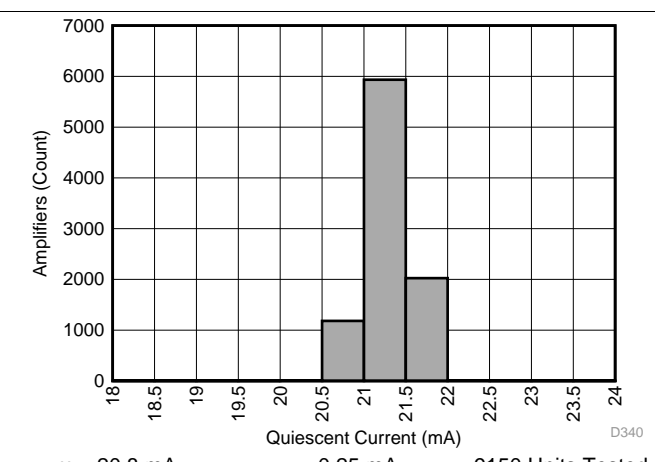
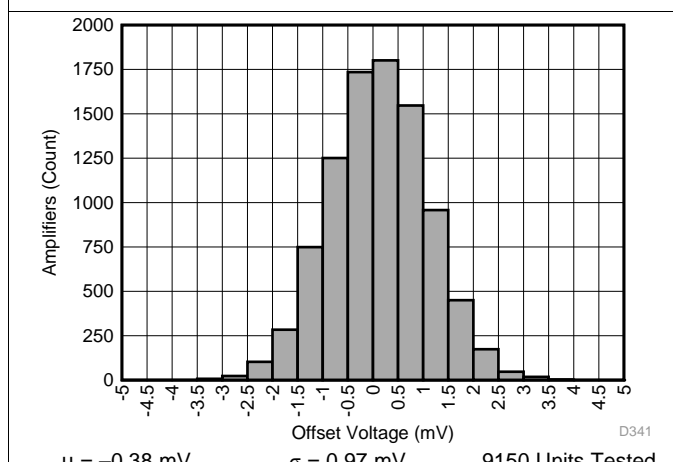

Figure 39. Output Swing vs Sourcing Current



$\mu = 20.8\text{ mA}$ $\sigma = 0.25\text{ mA}$ 9150 Units Tested

Figure 40. Quiescent Current Distribution



$\mu = -0.38\text{ mV}$ $\sigma = 0.97\text{ mV}$ 9150 Units Tested

Figure 41. Offset Voltage Distribution

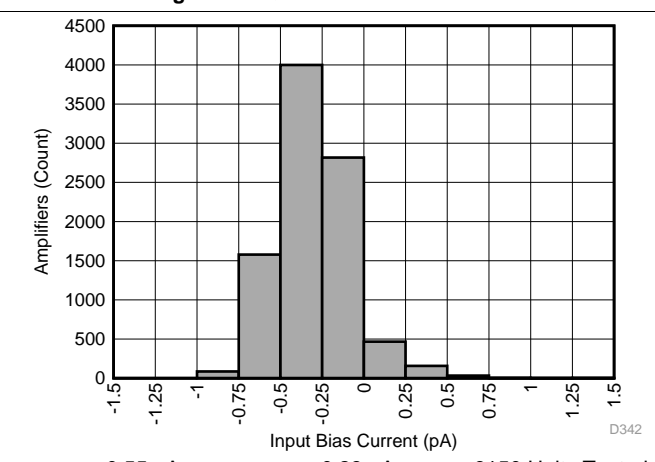

$\mu = -0.55\text{ pA}$ $\sigma = 0.23\text{ pA}$ 9150 Units Tested

Figure 42. Input Bias Current Distribution

8 Parameter Measurement Information

8.1 Parameter Measurement Information

The various test setup configurations for the OPA859 are shown in the figures below. When configuring the OPA859 as a noninverting amplifier in gains less 3 V/V, set $R_F = 150 \Omega$. When configuring the OPA859 as a noninverting amplifier in gains of 4 V/V and greater, set $R_F = 453 \Omega$.

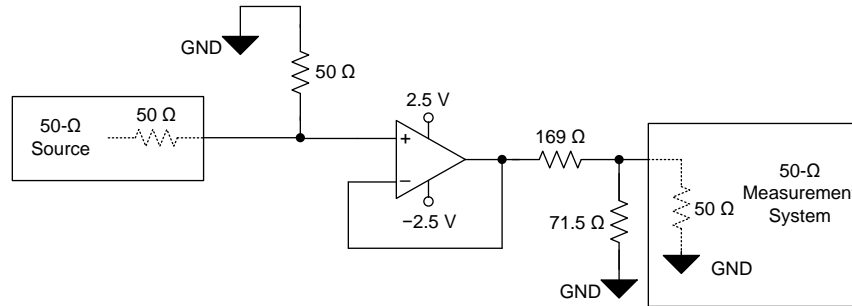
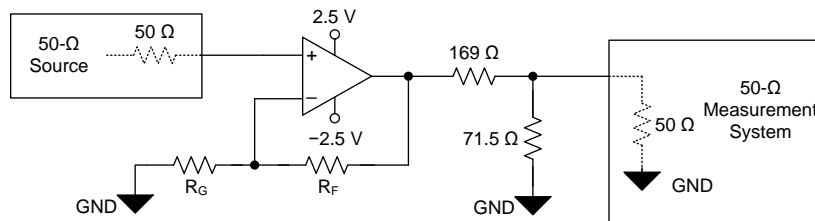

Figure 43. Unity-Gain Buffer Configuration



R_G values depend on gain configuration

Figure 44. Noninverting Configuration

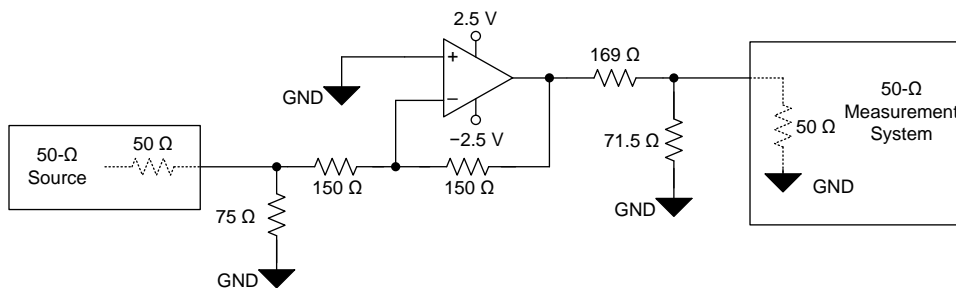

Figure 45. Inverting Configuration (Gain = -1 V/V)

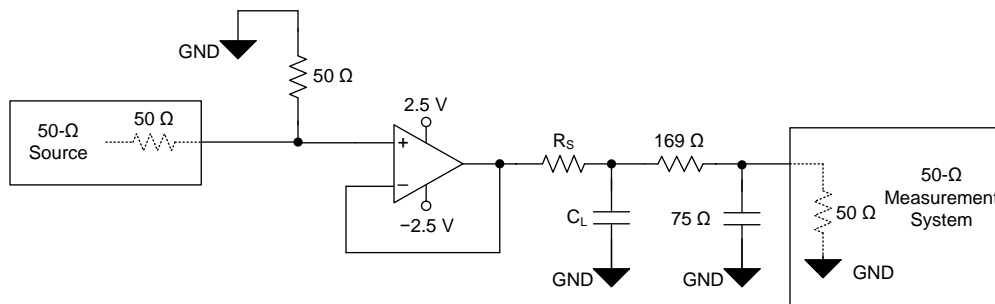

Figure 46. Capacitive Load Driver Configuration

9 Detailed Description

9.1 Overview

The ultra-wide, 900-MHz gain bandwidth product (GBWP) of the OPA859, combined with the broadband voltage noise of $3.3 \text{ nV}/\sqrt{\text{Hz}}$, produces a viable amplifier for wideband transimpedance applications, high-speed data acquisition systems, and applications with weak signal inputs that require low-noise and high-gain front ends. The OPA859 combines multiple features to optimize dynamic performance. In addition to the wide small-signal bandwidth, the OPA859 has 400 MHz of large-signal bandwidth ($V_{\text{OUT}} = 2 V_{\text{PP}}$), and a slew rate of $1150 \text{ V}/\mu\text{s}$.

The OPA859 is offered in a 2-mm x 2-mm, 8-pin WSON package that features a feedback (FB) pin for a simple feedback network connection between the amplifiers output and inverting input. Excess capacitance on an amplifiers input pin can reduce phase margin causing instability. This problem is exacerbated in the case of very wideband amplifiers like the OPA859. To reduce the effects of stray capacitance on the input node, the OPA859 pinout features an isolation pin (NC) between the feedback and inverting input pins that increases the physical spacing between them thereby reducing parasitic coupling at high frequencies. The OPA859 also features a very low capacitance input stage with only 0.8-pF of total input capacitance.

9.2 Functional Block Diagram

The OPA859 is a classic, voltage feedback operational amplifier (op amp) with two high-impedance inputs and a low-impedance output. Standard application circuits are supported, like the two basic options shown in [Figure 47](#) and [Figure 48](#). The DC operating point for each configuration is level-shifted by the reference voltage (V_{REF}), which is typically set to midsupply in single-supply operation. V_{REF} is typically connected to ground in split-supply applications.

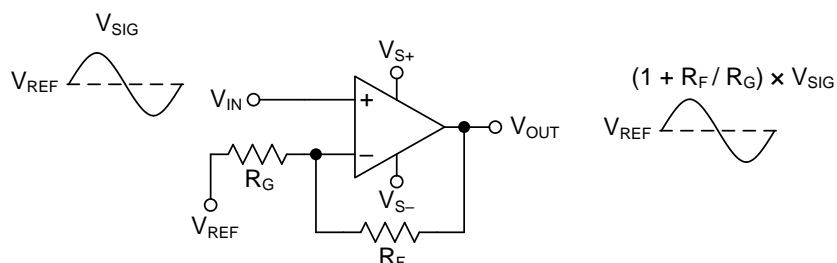

Figure 47. Noninverting Amplifier

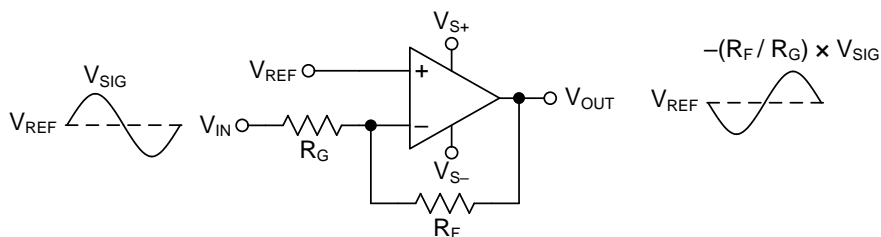

Figure 48. Inverting Amplifier

9.3 Feature Description

9.3.1 Input and ESD Protection

The OPA859 is fabricated on a low-voltage, high-speed, BiCMOS process. The internal, junction breakdown voltages are low for these small geometry devices, and as a result, all device pins are protected with internal ESD protection diodes to the power supplies as Figure 49 shows. There are two antiparallel diodes between the inputs of the amplifier that clamp the inputs during an overrange or fault condition.

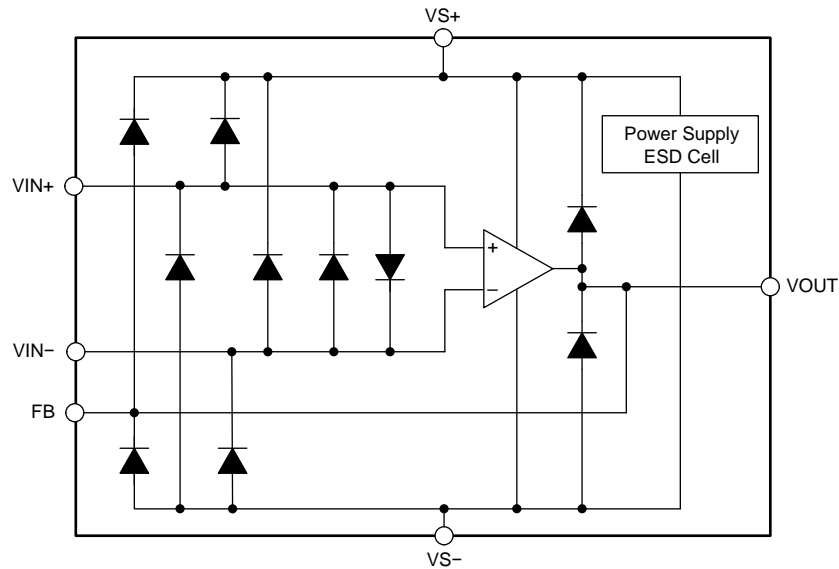

Figure 49. Internal ESD Structure

9.3.2 Feedback Pin

The OPA859 pin layout is optimized to minimize parasitic inductance and capacitance, which is critical in high-speed analog design. The FB pin (pin 1) is internally connected to the output of the amplifier. The FB pin is separated from the inverting input of the amplifier (pin 3) by a no connect (NC) pin (pin 2). The NC pin must be left floating. There are two advantages to this pin layout:

1. A feedback resistor (R_F) can connect between the FB and IN- pin on the same side of the package (see Figure 50) rather than going around the package.
2. The isolation created by the NC pin minimizes the capacitive coupling between the FB and IN- pins by increasing the physical separation between the pins.

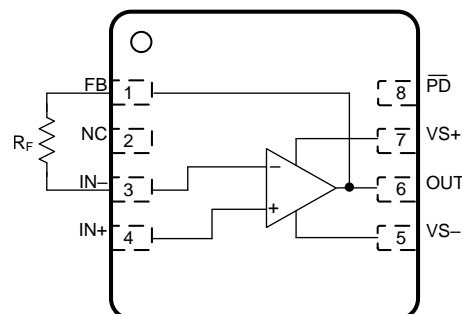

Figure 50. R_F Connection Between FB and IN- Pins

Feature Description (continued)

9.3.3 Wide Gain-Bandwidth Product

Figure 10 shows the open-loop magnitude and phase response of the OPA859. Calculate the gain bandwidth product of any op amp by determining the frequency at which the A_{OL} is 40 dB and multiplying that frequency by a factor of 100. The open-loop response shows the OPA859 to have approximately 63° of phase-margin when configured as a unity-gain buffer.

Figure 51 shows the open-loop magnitude (A_{OL}) of the OPA859 as a function of temperature. The results show approximately 5° of phase-margin variation over the entire temperature range. Semiconductor process variation is the naturally occurring variation in the attributes of a transistor (Early-voltage, β , channel-length and width) and other passive elements (resistors and capacitors) when fabricated into an integrated circuit. The process variation can occur across devices on a single wafer, or, across devices over multiple wafer lots over time. Typically the variation across a single wafer is tightly controlled. Figure 52 shows the A_{OL} magnitude of the OPA859 as a function of process variation over time. The results show the A_{OL} curve for the nominal process corner and the variation one standard deviation from the nominal. The simulated results show less than 2° of phase-margin difference within a standard deviation of process variation when the amplifier is configured as a unity-gain buffer.

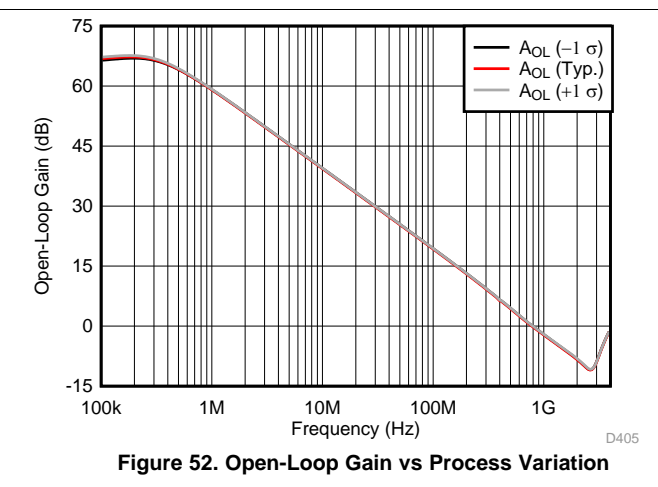
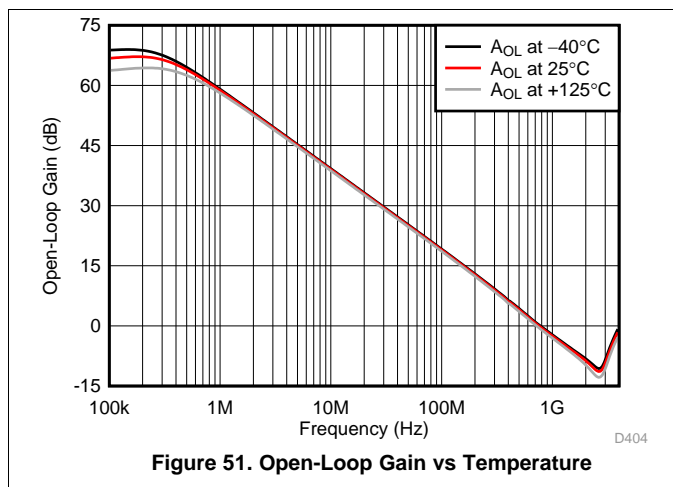

Feature Description (continued)

9.3.4 Slew Rate and Output Stage

In addition to wide bandwidth, the OPA859 features a high slew rate of 1150 V/ μ s. The slew rate is a critical parameter in high-speed pulse applications with narrow sub-10-ns pulses, such as optical time-domain reflectometry (OTDR) and LIDAR. The high slew rate of the OPA859 implies that the device accurately reproduces a 2-V, sub-ns pulse edge, as seen in [Figure 20](#). The wide bandwidth and slew rate of the OPA859 make it an excellent amplifier for high-speed, signal-chain front ends.

[Figure 53](#) shows the open-loop output impedance of the OPA859 as a function of frequency. To achieve high slew rates and low output impedance across frequency, the output swing of the OPA859 is limited to approximately 3 V. The OPA859 is typically used in conjunction with high-speed pipeline ADCs and flash ADCs that have limited input ranges. Therefore, the OPA859 output swing range coupled with the class-leading voltage noise specification for a CMOS amplifier maximizes the overall dynamic range of the signal chain.

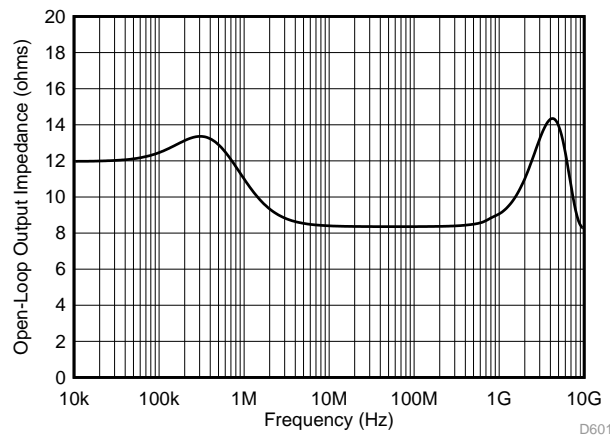

Figure 53. Open-Loop Output Impedance (Z_{OL}) vs Frequency

9.3.5 Current Noise

The input impedance of CMOS and JFET input amplifiers at low frequencies exceed several G Ω s. However, at higher frequencies, the transistors parasitic capacitance to the drain, source, and substrate reduces the impedance. The high impedance at low frequencies eliminates any bias current and the associated shot noise. At higher frequencies, the input current noise increases (see [Figure 54](#)) as a result of capacitive coupling between the CMOS gate oxide and the underlying transistor channel. This phenomenon is a natural artifact of the construction of the transistor and is unavoidable.

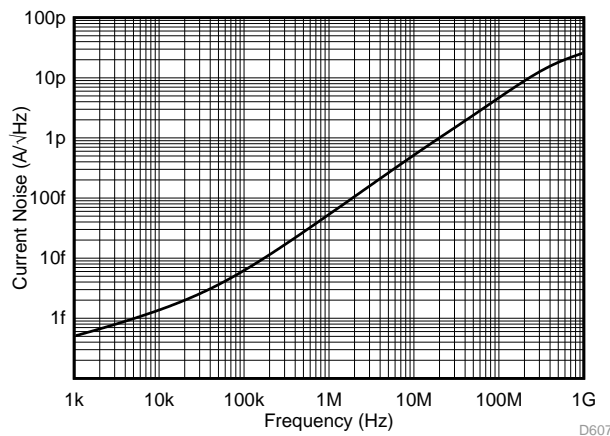

Figure 54. Input Current Noise (I_{BN} and I_{BI}) vs Frequency

9.4 Device Functional Modes

9.4.1 Split-Supply and Single-Supply Operation

The OPA859 can be configured with single-sided supplies or split-supplies as shown in [Figure 60](#). Split-supply operation using balanced supplies with the input common-mode set to ground eases lab testing because most signal generators, network analyzers, spectrum analyzers, and other lab equipment typically reference inputs and outputs to ground. Split-supply operation is preferred in systems where the signals swing around ground. However, the system requires two supply rails. In split-supply operation, the thermal pad must be connected to the negative supply.

Newer systems use a single power supply to improve efficiency and reduce the cost of the extra power supply. The OPA859 can be used with a single positive supply (negative supply at ground) with no change in performance if the input common-mode and output swing are biased within the linear operation of the device. In single-supply operation, level shift the dc input and output reference voltages by half the difference between the power supply rails. This configuration maintains the input common-mode and output load reference at midsupply. To eliminate gain errors, the source driving the reference input common-mode voltage must have low output impedance across the frequency range of interest. In this case, the thermal pad must be connected to ground.

9.4.2 Power-Down Mode

The OPA859 features a power-down mode to reduce the quiescent current to conserve power. [Figure 23](#) and [Figure 24](#) show the transient response of the OPA859 as the $\overline{\text{PD}}$ pin toggles between the disabled and enabled states.

The $\overline{\text{PD}}$ disable and enable threshold voltages are with reference to the negative supply. If the amplifier is configured with the positive supply at 3.3 V and the negative supply at ground, then the disable and enable threshold voltages are 0.65 V and 1.8 V, respectively. If the amplifier is configured with $\pm 1.65\text{-V}$ supplies, then the disable and enable threshold voltages are at -1 V and 0.15 V , respectively. If the amplifier is configured with $\pm 2.5\text{-V}$ supplies, then the threshold voltages are at -1.85 V and -0.7 V .

[Figure 55](#) shows the switching behavior of a typical amplifier as the $\overline{\text{PD}}$ pin is swept down from the enabled state to the disabled state. Similarly, [Figure 56](#) shows the switching behavior of a typical amplifier as the $\overline{\text{PD}}$ pin is swept up from the disabled state to the enabled state. The small difference in the switching thresholds between the down sweep and the up sweep is caused by the hysteresis designed into the amplifier to increase immunity to noise on the $\overline{\text{PD}}$ pin.

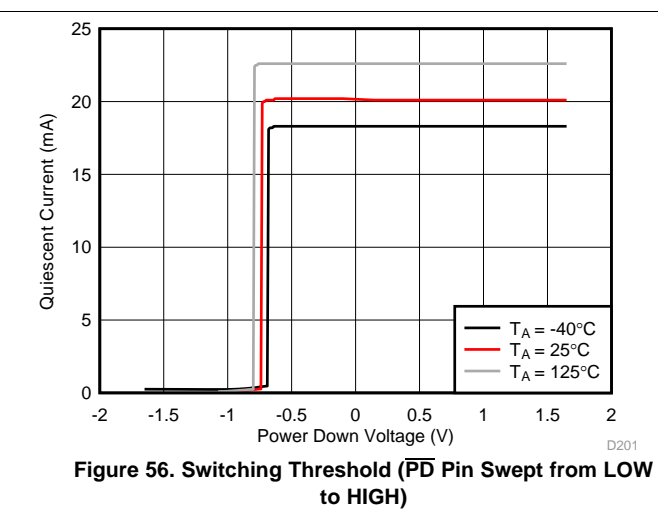
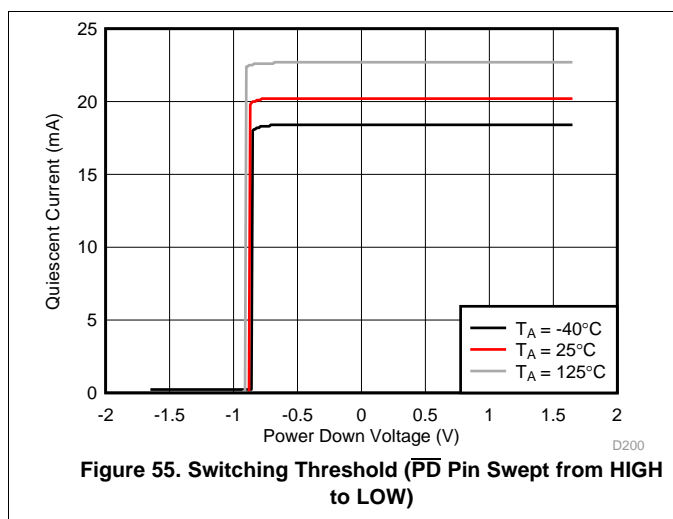

Connecting the $\overline{\text{PD}}$ pin low disables the amplifier and places the output in a high-impedance state. When the amplifier is configured as a noninverting amplifier, the feedback (R_F) and gain (R_G) resistor network form a parallel load to the output of the amplifier. To protect the input stage of the amplifier, the OPA859 uses internal, back-to-back protection diodes between the inverting and noninverting input pins as [Figure 49](#) shows. In the power-down state, if the differential voltage between the input pins of the amplifier exceeds a diode voltage drop, an additional low-impedance path is created between the noninverting input pin and the output pin.

10 Application and Implementation

NOTE

Information in the following applications sections is not part of the TI component specification, and TI does not warrant its accuracy or completeness. TI's customers are responsible for determining suitability of components for their purposes. Customers should validate and test their design implementation to confirm system functionality.

10.1 Application Information

The OPA859 offers high input impedance, very high-bandwidth, high slew-rate, low noise, and better than –60 dBc of distortion performance at frequencies up to 100 MHz. These features make this device an excellent front-end buffer in high-speed data acquisition systems. The wide bandwidth also makes this amplifier an excellent choice for high-gain active filter systems.

10.2 Typical Application

Figure 57 shows the OPA859 configured as a transimpedance amplifier (U1) in a wide-bandwidth, optical front-end system. A second OPA859 configured as a unity-gain buffer (U2) sets a dc offset voltage to the THS4520. The THS4520 is used to convert the single-ended transimpedance output of the OPA859 into a differential output signal. The THS4520 drives the input of the ADS54J64, 14-bit, 1-GSPS analog-to-digital converter (ADC) that digitizes the analog signal.

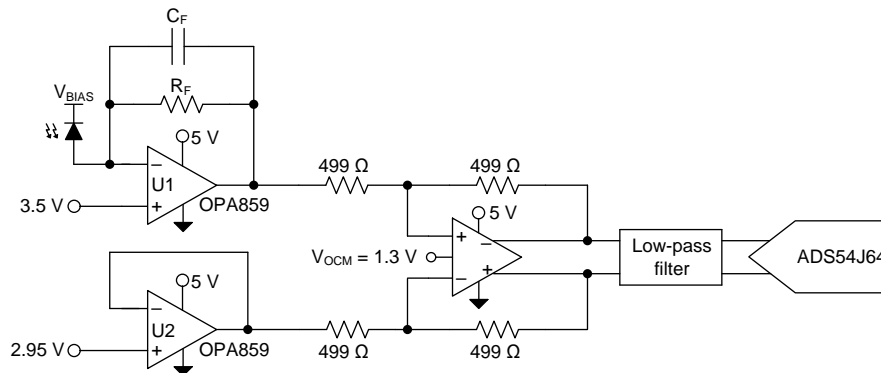

Figure 57. OPA859 as Both a TIA and a Buffer in an Optical Front-End System

10.2.1 Design Requirements

The objective is to design a low noise, wideband optical front-end system using the OPA859 as a transimpedance amplifier. The design requirements are:

- Amplifier supply voltage: 5 V
- TIA common-mode voltage: 3.5 V
- THS4520 gain: 1 V/V
- ADC input common-mode voltage: 1.3 V
- ADC analog differential input range: 1.1 V_{PP}

10.2.2 Detailed Design Procedure

The OPA859 meets the growing demand for wideband, low-noise photodiode amplifiers. The closed-loop bandwidth of a transimpedance amplifier is a function of the following:

1. The total input capacitance (C_{IN}). This total includes the photodiode capacitance, the input capacitance of the amplifier (common-mode and differential capacitance) and any stray capacitance from the PCB.
2. The op amp gain bandwidth product (GBWP).
3. The transimpedance gain (R_F).

Figure 57 shows the OPA859 configured as a TIA, with the avalanche photodiode (APD) reverse biased so that the APD cathode is tied to a large positive bias voltage. In this configuration, the APD sources current into the op amp feedback loop so that the output swings in a negative direction relative to the input common-mode voltage. To maximize the output swing in the negative direction, the OPA859 common-mode voltage is set close to the positive limit; only 1.5 V from the positive supply rail. The feedback resistance (R_F) and the input capacitance (C_{IN}) form a zero in the noise gain that results in instability if left unchecked. To counteract the effect of the zero, a pole is inserted into the noise gain transfer function by adding the feedback capacitor (C_F).

The *Transimpedance Considerations for High-Speed Amplifiers Application Report* discusses theories and equations that show how to compensate a transimpedance amplifier for a particular transimpedance gain and input capacitance. The bandwidth and compensation equations from the application report are available in an Excel™ calculator. *What You Need To Know About Transimpedance Amplifiers – Part 1* provides a link to the calculator.

Typical Application (continued)

The equations and calculators in the referenced application report and blog posts are used to model the bandwidth (f_{-3dB}) and noise (I_{RN}) performance of the OPA859 configured as a TIA. The resultant performance is shown in [Figure 58](#) and [Figure 59](#). The left-side Y-axis shows the closed-loop bandwidth performance, whereas the right side of the graph shows the integrated input-referred noise. The noise bandwidth to calculate I_{RN} for a fixed R_F and C_{PD} is set equal to the f_{-3dB} frequency. [Figure 58](#) shows the amplifier performance as a function of photodiode capacitance (C_{PD}) for $R_F = 10\text{ k}\Omega$ and $20\text{ k}\Omega$. Increasing C_{PD} decreases the closed-loop bandwidth. To maximize bandwidth, make sure to reduce any stray parasitic capacitance from the PCB. The OPA859 is designed with 0.8 pF of total input capacitance to minimize the effect of stray capacitance on system performance. [Figure 59](#) shows the amplifier performance as a function of R_F for $C_{PD} = 1\text{ pF}$ and 2 pF . Increasing R_F results in lower bandwidth. To maximize the signal-to-noise ratio (SNR) in an optical front-end system, maximize the gain in the TIA stage. Increasing R_F by a factor of X increases the signal level by X , but only increases the resistor noise contribution by \sqrt{X} , thereby improving SNR.

The OPA859 configured as a unity-gain buffer drives a dc offset voltage of 2.95 V into the lower half of the THS4520. To maximize the dynamic range of the ADC, the two OPA859 amplifiers drive a differential common-mode of 3.5 V and 2.95 V into the THS4520. The dc offset voltage of the buffer amplifier can be derived using [Equation 1](#).

$$V_{BUF_DC} = V_{TIA_CM} - \left(\frac{1}{2} \times \frac{V_{ADC_DIFF_IN}}{\left(\frac{R_F}{R_G} \right)} \right)$$

where

- V_{TIA_CM} is the common-mode voltage of the TIA (3.5 V)
- $V_{ADC_DIFF_IN}$ is the differential input voltage range of the ADC (1.1 V_{PP})
- R_F and R_G are the feedback resistance ($499\ \Omega$) and gain resistance ($499\ \Omega$) of the THS4520 differential amplifier

(1)

The low-pass filter between the THS4520 and the ADC54J64 minimizes high-frequency noise and maximizes SNR. The ADC54J64 has an internal buffer that isolates the output of the THS4520 from the ADC sampling-capacitor input, so a traditional charge bucket filter is not required.

10.2.3 Application Curves

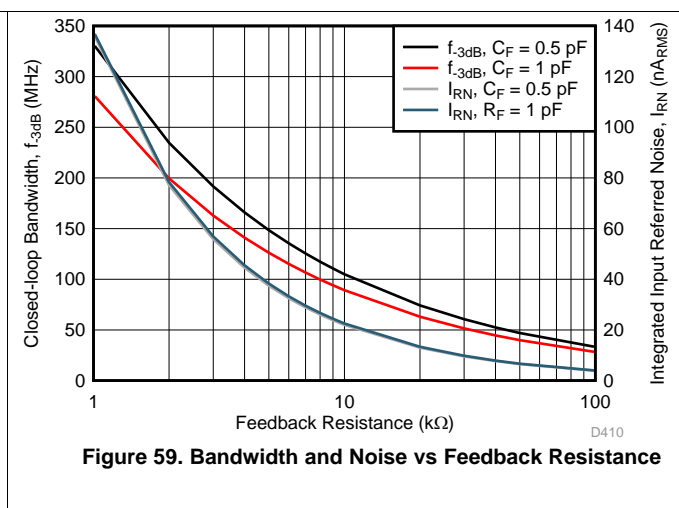
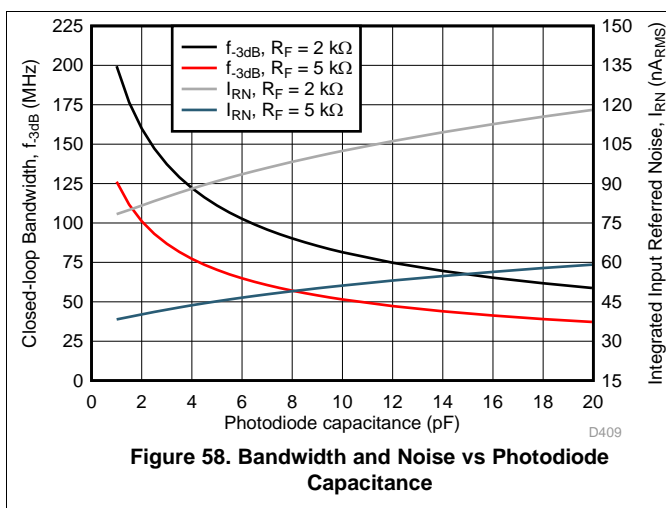

11 Power Supply Recommendations

The OPA859 operates on supplies from 3.3 V to 5.25 V. The OPA859 operates on single-sided supplies, split and balanced bipolar supplies, and unbalanced bipolar supplies. Because the OPA859 does not feature rail-to-rail inputs or outputs, the input common-mode and output swing ranges are limited at 3.3-V supplies.

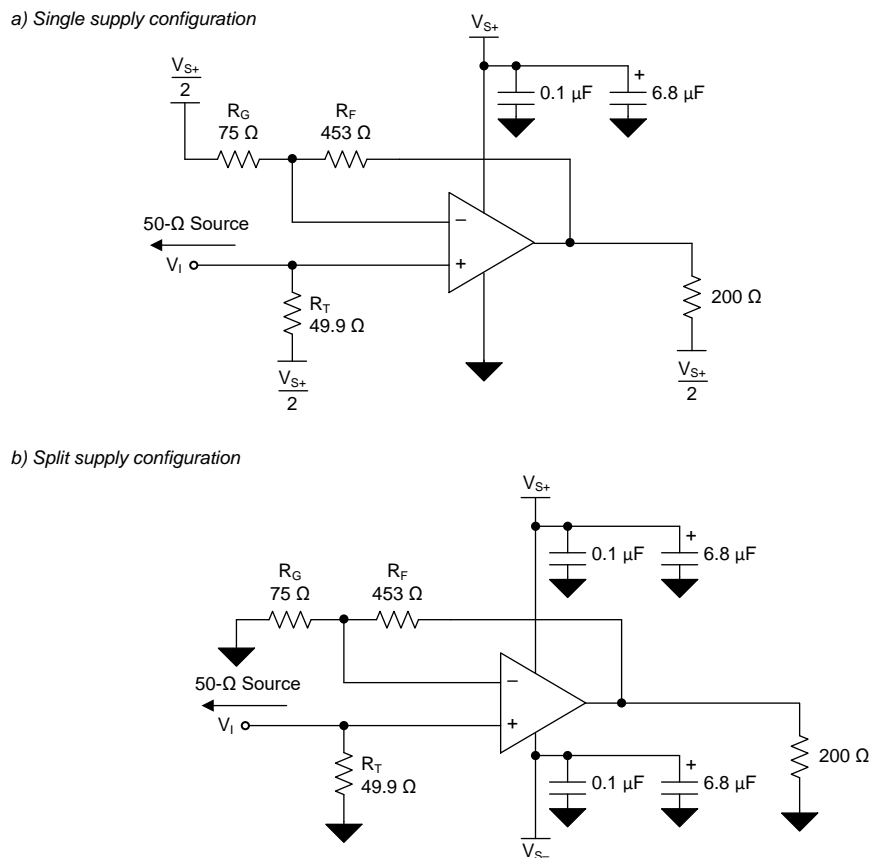

Figure 60. Split and Single Supply Circuit Configuration , Gain = 7 V/V

12 Layout

12.1 Layout Guidelines

Achieving optimum performance with a high-frequency amplifier like the OPA859 requires careful attention to board layout parasitics and external component types. Recommendations that optimize performance include:

- Minimize parasitic capacitance from the signal I/O pins to ac ground.** Parasitic capacitance on the output and inverting input pins can cause instability. To reduce unwanted capacitance, cut out the power and ground traces under the signal input and output pins. Otherwise, ground and power planes must be unbroken elsewhere on the board. When configuring the amplifier as a TIA, if the required feedback capacitor is less than 0.15 pF, consider using two series resistors, each of half the value of a single resistor in the feedback loop to minimize the parasitic capacitance from the resistor.
- Minimize the distance (less than 0.25") from the power-supply pins to high-frequency bypass capacitors.** Use high-quality, 100-pF to 0.1- μ F, C0G and NPO-type decoupling capacitors with voltage ratings at least three times greater than the amplifiers maximum power supplies. This configuration makes sure that there is a low-impedance path to the amplifiers power-supply pins across the amplifiers gain bandwidth specification. At the device pins, do not allow the ground and power plane layout to be in close proximity to the signal I/O pins. Avoid narrow power and ground traces to minimize inductance between the pins and the decoupling capacitors. The power-supply connections must always be decoupled with these capacitors. Larger (2.2- μ F to 6.8- μ F) decoupling capacitors that are effective at lower frequency must be used on the supply pins. Place these decoupling capacitors further from the device. Share the decoupling capacitors among several devices in the same area of the printed circuit board (PCB).
- Careful selection and placement of external components preserves the high-frequency performance of the OPA859.** Use low-reactance resistors. Surface-mount resistors work best and allow a tighter overall layout. Never use wirewound resistors in a high-frequency application. Because the output pin and inverting input pin are the most sensitive to parasitic capacitance, always position the feedback and series output resistor, if any, as close to the output pin as possible. Place other network components (such as noninverting input termination resistors) close to the package. Even with a low parasitic capacitance shunting the external resistors, high resistor values create significant time constants that can degrade performance. When configuring the OPA859 as a voltage amplifier, keep resistor values as low as possible and consistent with load driving considerations. Decreasing the resistor values keeps the resistor noise terms low and minimizes the effect of the parasitic capacitance. However, lower resistor values increase the dynamic power consumption because R_F and R_G become part of the output load network of the amplifier.

12.2 Layout Example

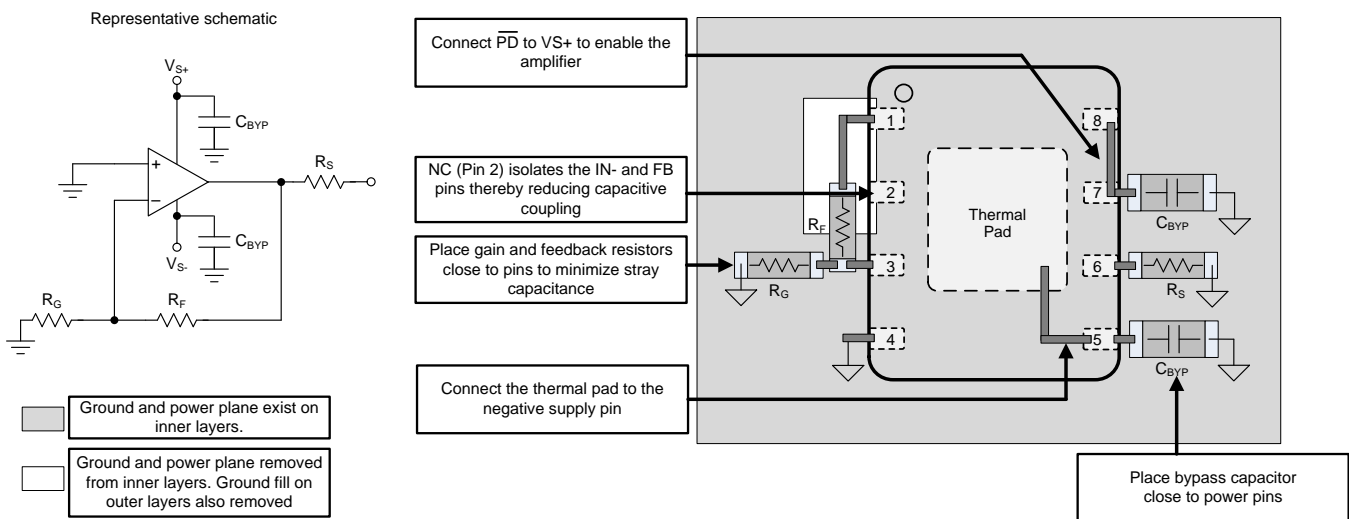

Figure 61. Layout Recommendation

13 Device and Documentation Support

13.1 Device Support

13.1.1 Development Support

- [Wide Bandwidth Optical Front-end Reference Design](#)
- [LIDAR-Pulsed Time-of-Flight Reference Design Using High-Speed Data Converters](#)
- [LIDAR Pulsed Time of Flight Reference Design](#)

13.2 Documentation Support

13.2.1 Related Documentation

For related documentation see the following:

- [OPA858EVM User's Guide](#)
- [Transimpedance Considerations for High-Speed Amplifiers Application Report](#)
- [What You Need To Know About Transimpedance Amplifiers – Part 1](#)
- [What You Need To Know About Transimpedance Amplifiers – Part 2](#)
- [Training Video: How to Design Transimpedance Amplifier Circuits](#)
- [Training Video: High-Speed Transimpedance Amplifier Design Flow](#)
- [Training Video: How to Convert a TINA-TI Model into a Generic SPICE Model](#)

13.3 Receiving Notification of Documentation Updates

To receive notification of documentation updates, navigate to the device product folder on ti.com. In the upper right corner, click on *Alert me* to register and receive a weekly digest of any product information that has changed. For change details, review the revision history included in any revised document.

13.4 Community Resources

The following links connect to TI community resources. Linked contents are provided "AS IS" by the respective contributors. They do not constitute TI specifications and do not necessarily reflect TI's views; see TI's [Terms of Use](#).

TI E2E™ Online Community *TI's Engineer-to-Engineer (E2E) Community*. Created to foster collaboration among engineers. At e2e.ti.com, you can ask questions, share knowledge, explore ideas and help solve problems with fellow engineers.

Design Support *TI's Design Support* Quickly find helpful E2E forums along with design support tools and contact information for technical support.

13.5 Trademarks

E2E is a trademark of Texas Instruments.

Excel is a trademark of Microsoft Corporation.

All other trademarks are the property of their respective owners.

13.6 Electrostatic Discharge Caution



This integrated circuit can be damaged by ESD. Texas Instruments recommends that all integrated circuits be handled with appropriate precautions. Failure to observe proper handling and installation procedures can cause damage.

ESD damage can range from subtle performance degradation to complete device failure. Precision integrated circuits may be more susceptible to damage because very small parametric changes could cause the device not to meet its published specifications.

13.7 Glossary

[SLYZ022](#) — *TI Glossary*.

This glossary lists and explains terms, acronyms, and definitions.

14 Mechanical, Packaging, and Orderable Information

The following pages include mechanical, packaging, and orderable information. This information is the most current data available for the designated devices. This data is subject to change without notice and revision of this document. For browser-based versions of this data sheet, refer to the left-hand navigation.

PACKAGING INFORMATION

Orderable Device	Status (1)	Package Type	Package Drawing	Pins	Package Qty	Eco Plan (2)	Lead finish/ Ball material (6)	MSL Peak Temp (3)	Op Temp (°C)	Device Marking (4/5)	Samples
OPA859IDSGR	ACTIVE	WSON	DSG	8	3000	RoHS & Green	NIPDAU	Level-1-260C-UNLIM	-40 to 125	859	Samples
OPA859IDSGT	ACTIVE	WSON	DSG	8	250	RoHS & Green	NIPDAU	Level-1-260C-UNLIM	-40 to 125	859	Samples

(1) The marketing status values are defined as follows:

ACTIVE: Product device recommended for new designs.

LIFEBUY: TI has announced that the device will be discontinued, and a lifetime-buy period is in effect.

NRND: Not recommended for new designs. Device is in production to support existing customers, but TI does not recommend using this part in a new design.

PREVIEW: Device has been announced but is not in production. Samples may or may not be available.

OBSELETE: TI has discontinued the production of the device.

(2) **RoHS:** TI defines "RoHS" to mean semiconductor products that are compliant with the current EU RoHS requirements for all 10 RoHS substances, including the requirement that RoHS substance do not exceed 0.1% by weight in homogeneous materials. Where designed to be soldered at high temperatures, "RoHS" products are suitable for use in specified lead-free processes. TI may reference these types of products as "Pb-Free".

RoHS Exempt: TI defines "RoHS Exempt" to mean products that contain lead but are compliant with EU RoHS pursuant to a specific EU RoHS exemption.

Green: TI defines "Green" to mean the content of Chlorine (Cl) and Bromine (Br) based flame retardants meet JS709B low halogen requirements of <=1000ppm threshold. Antimony trioxide based flame retardants must also meet the <=1000ppm threshold requirement.

(3) MSL, Peak Temp. - The Moisture Sensitivity Level rating according to the JEDEC industry standard classifications, and peak solder temperature.

(4) There may be additional marking, which relates to the logo, the lot trace code information, or the environmental category on the device.

(5) Multiple Device Markings will be inside parentheses. Only one Device Marking contained in parentheses and separated by a "~" will appear on a device. If a line is indented then it is a continuation of the previous line and the two combined represent the entire Device Marking for that device.

(6) Lead finish/Ball material - Orderable Devices may have multiple material finish options. Finish options are separated by a vertical ruled line. Lead finish/Ball material values may wrap to two lines if the finish value exceeds the maximum column width.

Important Information and Disclaimer:The information provided on this page represents TI's knowledge and belief as of the date that it is provided. TI bases its knowledge and belief on information provided by third parties, and makes no representation or warranty as to the accuracy of such information. Efforts are underway to better integrate information from third parties. TI has taken and continues to take reasonable steps to provide representative and accurate information but may not have conducted destructive testing or chemical analysis on incoming materials and chemicals. TI and TI suppliers consider certain information to be proprietary, and thus CAS numbers and other limited information may not be available for release.

In no event shall TI's liability arising out of such information exceed the total purchase price of the TI part(s) at issue in this document sold by TI to Customer on an annual basis.

OTHER QUALIFIED VERSIONS OF OPA859 :

- Automotive : [OPA859-Q1](#)

NOTE: Qualified Version Definitions:

- Automotive - Q100 devices qualified for high-reliability automotive applications targeting zero defects

TAPE AND REEL INFORMATION



QUADRANT ASSIGNMENTS FOR PIN 1 ORIENTATION IN TAPE



*All dimensions are nominal

Device	Package Type	Package Drawing	Pins	SPQ	Reel Diameter (mm)	Reel Width W1 (mm)	A0 (mm)	B0 (mm)	K0 (mm)	P1 (mm)	W (mm)	Pin1 Quadrant
OPA859IDSGR	WSON	DSG	8	3000	180.0	8.4	2.3	2.3	1.15	4.0	8.0	Q2
OPA859IDSGT	WSON	DSG	8	250	180.0	8.4	2.3	2.3	1.15	4.0	8.0	Q2

TAPE AND REEL BOX DIMENSIONS

*All dimensions are nominal

Device	Package Type	Package Drawing	Pins	SPQ	Length (mm)	Width (mm)	Height (mm)
OPA859IDSGR	WSON	DSG	8	3000	210.0	185.0	35.0
OPA859IDSGT	WSON	DSG	8	250	210.0	185.0	35.0

GENERIC PACKAGE VIEW

DSG 8

WSON - 0.8 mm max height

2 x 2, 0.5 mm pitch

PLASTIC SMALL OUTLINE - NO LEAD

This image is a representation of the package family, actual package may vary.
Refer to the product data sheet for package details.

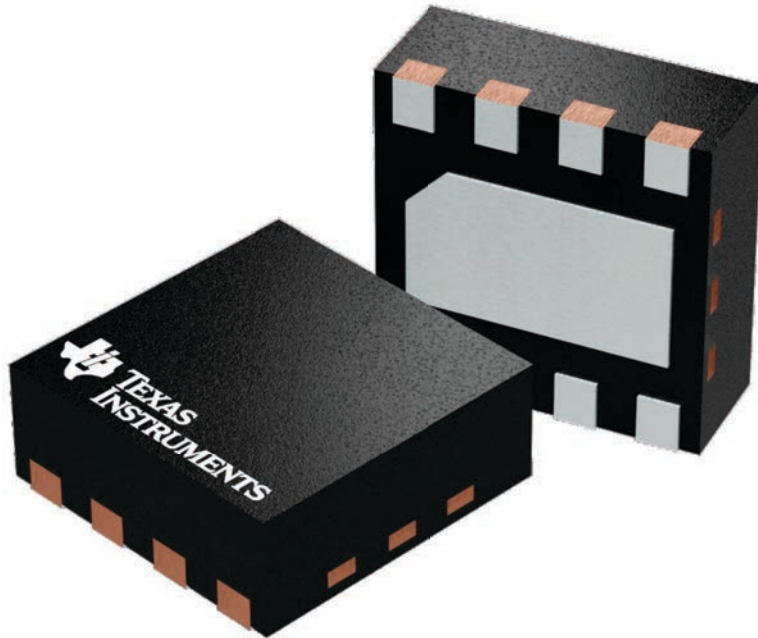

4224783/A

DSG0008A

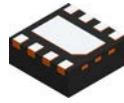

PACKAGE OUTLINE

WSON - 0.8 mm max height

PLASTIC SMALL OUTLINE - NO LEAD

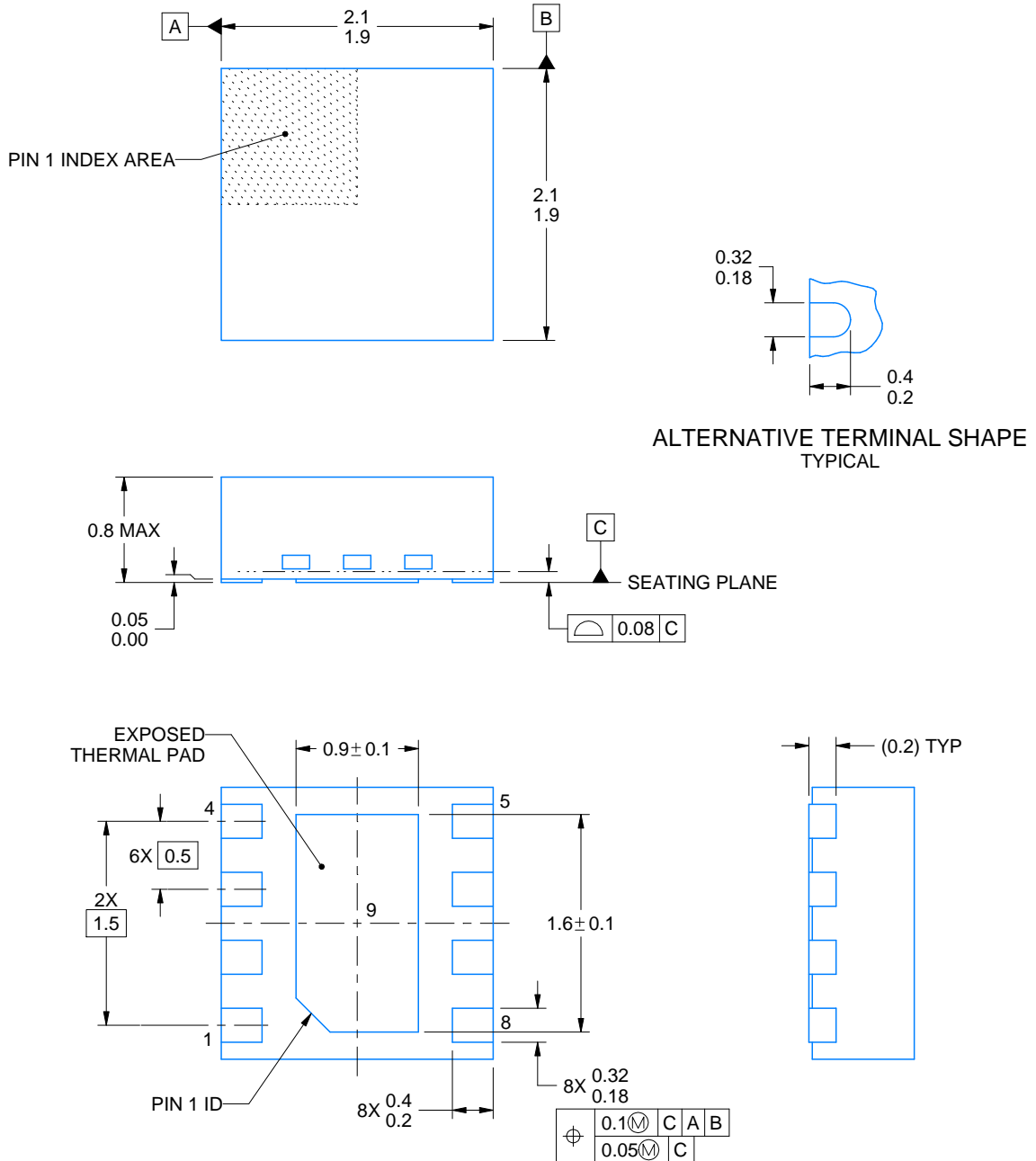

4218900/D 04/2020

NOTES:

1. All linear dimensions are in millimeters. Any dimensions in parenthesis are for reference only. Dimensioning and tolerancing per ASME Y14.5M.
2. This drawing is subject to change without notice.
3. The package thermal pad must be soldered to the printed circuit board for thermal and mechanical performance.

IMPORTANT NOTICE AND DISCLAIMER

TI PROVIDES TECHNICAL AND RELIABILITY DATA (INCLUDING DATASHEETS), DESIGN RESOURCES (INCLUDING REFERENCE DESIGNS), APPLICATION OR OTHER DESIGN ADVICE, WEB TOOLS, SAFETY INFORMATION, AND OTHER RESOURCES "AS IS" AND WITH ALL FAULTS, AND DISCLAIMS ALL WARRANTIES, EXPRESS AND IMPLIED, INCLUDING WITHOUT LIMITATION ANY IMPLIED WARRANTIES OF MERCHANTABILITY, FITNESS FOR A PARTICULAR PURPOSE OR NON-INFRINGEMENT OF THIRD PARTY INTELLECTUAL PROPERTY RIGHTS.

These resources are intended for skilled developers designing with TI products. You are solely responsible for (1) selecting the appropriate TI products for your application, (2) designing, validating and testing your application, and (3) ensuring your application meets applicable standards, and any other safety, security, or other requirements. These resources are subject to change without notice. TI grants you permission to use these resources only for development of an application that uses the TI products described in the resource. Other reproduction and display of these resources is prohibited. No license is granted to any other TI intellectual property right or to any third party intellectual property right. TI disclaims responsibility for, and you will fully indemnify TI and its representatives against, any claims, damages, costs, losses, and liabilities arising out of your use of these resources.

TI's products are provided subject to TI's Terms of Sale (<https://www.ti.com/legal/termsofsale.html>) or other applicable terms available either on [ti.com](https://www.ti.com) or provided in conjunction with such TI products. TI's provision of these resources does not expand or otherwise alter TI's applicable warranties or warranty disclaimers for TI products.

Mailing Address: Texas Instruments, Post Office Box 655303, Dallas, Texas 75265
Copyright © 2021, Texas Instruments Incorporated