

The MPC942 is a 1:18 low voltage clock distribution chip with 2.5V or 3.3V LVC MOS output capabilities. The device is offered in two versions; the MPC942C has an LVC MOS input clock while the MPC942P has a LVPECL input clock. The 18 outputs are 2.5V or 3.3V LVC MOS compatible and feature the drive strength to drive 50Ω series or parallel terminated transmission lines. With output-to-output skews of 200ps, the MPC942 is ideal as a clock distribution chip for the most demanding of synchronous systems. The 2.5V outputs also make the device ideal for supplying clocks for a high performance Pentium II™ microprocessor based design.

- LVC MOS/LVTTL Clock Input
- 2.5V LVC MOS Outputs for Pentium II Microprocessor Support
- 150ps Maximum Targeted Output-to-Output Skew
- Maximum Output Frequency of 250MHz @ 3.3 V<sub>CC</sub>
- 32-Lead TQFP Packaging
- Single 3.3V or 2.5V Supply
- **For Functional replacement use 83940DYLF**

With a low output impedance (≈12Ω), in both the HIGH and LOW logic states, the output buffers of the MPC942 are ideal for driving series terminated transmission lines. With an output impedance of 12Ω the MPC942 can drive two series terminated transmission lines from each output. This capability gives the MPC942 an effective fanout of 1:36. The MPC942 provides enough copies of low skew clocks for most high performance synchronous systems.

The LVC MOS/LVTTL input of the MPC942C provides a more standard LVC MOS interface. The OE pins will place the outputs into a high impedance state. The OE pin has an internal pullup resistor.

The MPC942 is a single supply device. The V<sub>CC</sub> power pins require either 2.5V or 3.3V. The 32-lead TQFP package was chosen to optimize performance, board space and cost of the device. The 32-lead TQFP has a 7x7mm body size with a conservative 0.8mm pin spacing.

**MPC942C**

**LOW VOLTAGE  
 1:18 CLOCK  
 DISTRIBUTION CHIP**



**AC SUFFIX**  
 32-LEAD TQFP PACKAGE  
**Pb-FREE PACKAGE**  
 CASE 873A-03

Pentium II is a trademark of Intel Corporation.

LOGIC DIAGRAM

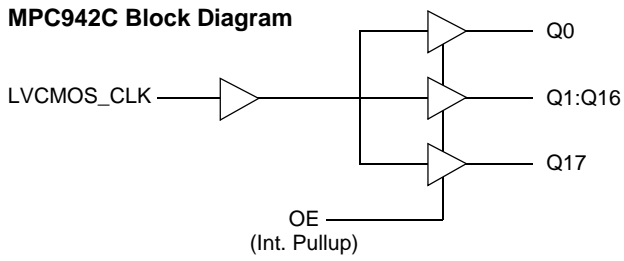

FUNCTION TABLE

OE	Output
0	HIGH IMPEDANCE
1	OUTPUTS ENABLED

Pinout: 32-Lead (Top View)

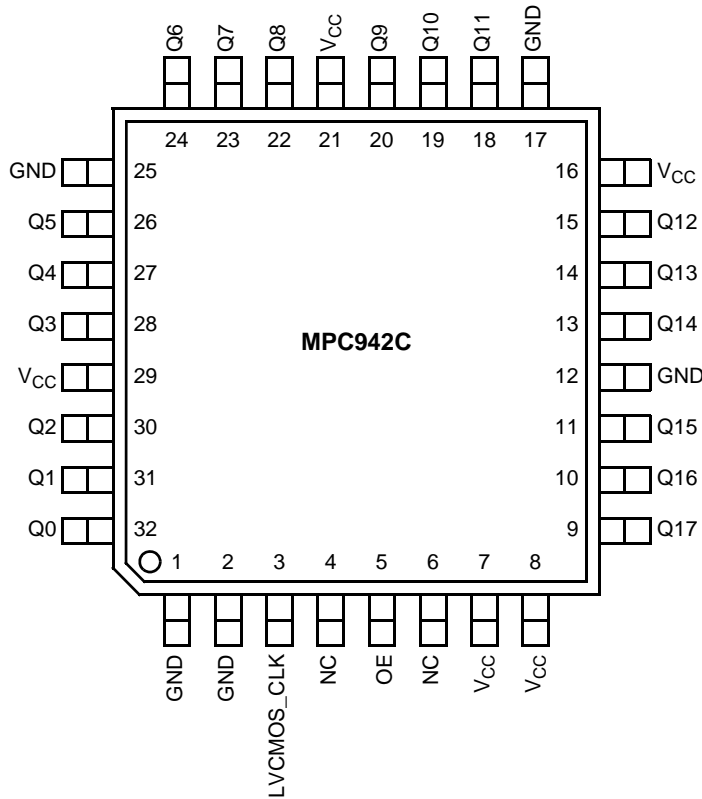

Table 1. Absolute Maximum Ratings

Symbol	Parameter	Min	Max	Unit
V <sub>CC</sub>	Supply Voltage	-0.3	3.6	V
V <sub>I</sub>	Input Voltage	-0.3	V <sub>CC</sub> + 0.3	V
I <sub>IN</sub>	Input Current		±20	mA
T <sub>Stor</sub>	Storage Temperature Range	-40	125	°C

**Table 2. DC Characteristics** ( $T_A = 0^\circ$  to  $70^\circ\text{C}$ ,  $V_{CCI} = 2.5\text{V} \pm 5\%$ ,  $V_{CCO} = 2.5\text{V} \pm 5\%$ )

Symbol	Characteristic	Min	Typ	Max	Unit	Condition
$V_{IH}$	Input HIGH Voltage	2.0		$V_{CCI}$	V	
$V_{IL}$	Input LOW Voltage			0.8	V	
$V_{OH}$	Output HIGH Voltage	2.0			V	$I_{OH} = -16\text{ mA}$
$V_{OL}$	Output LOW Voltage			0.5	V	$I_{OL} = 16\text{ mA}$
$I_{IN}$	Input Current			$\pm 200$	$\mu\text{A}$	
$C_{IN}$	Input Capacitance		4.0		pF	
$C_{PD}$	Power Dissipation Capacitance		14		pF	Per Output
$Z_{OUT}$	Output Impedance		12		$\Omega$	
$I_{CC}$	Maximum Quiescent Supply Current		0.5		mA	

**Table 3. AC Characteristics** ( $T_A = 0^\circ$  to  $70^\circ\text{C}$ ,  $V_{CCI} = 2.5\text{V} \pm 5\%$ ,  $V_{CCO} = 2.5\text{V} \pm 5\%$ )

Symbol	Characteristic	Min	Typ	Max	Unit	Condition
$F_{max}$	Maximum Frequency			200	MHz	
$t_{PLH}$	Propagation Delay	1.5		2.8	ns	
$t_{sk(o)}$	Output-to-Output Skew			200	ps	
$t_{sk(pr)}$	Part-to-Part Skew			1.3	ns	Notes 1, 2
$t_{sk(pr)}$	Part-to-Part Skew			600	ps	Notes 1, 3
$d_t$	Duty Cycle	45		55	%	
$t_r, t_f$	Output Rise/Fall Time	0.2		1.0	ns	

**Table 4. DC Characteristics** ( $T_A = 0^\circ$  to  $70^\circ\text{C}$ ,  $V_{CCI} = 3.3\text{V} \pm 5\%$ ,  $V_{CCO} = 3.3\text{V} \pm 5\%$ )

Symbol	Characteristic	Min	Typ	Max	Unit	Condition
$V_{IH}$	Input HIGH Voltage	2.4		$V_{CCI}$	V	
$V_{IL}$	Input LOW Voltage			0.8	V	
$V_{OH}$	Output HIGH Voltage	2.4			V	$I_{OH} = -20\text{ mA}$
$V_{OL}$	Output LOW Voltage			0.5	V	$I_{OL} = 20\text{ mA}$
$I_{IN}$	Input Current			$\pm 200$	$\mu\text{A}$	
$C_{IN}$	Input Capacitance		4.0		pF	
$C_{PD}$	Power Dissipation Capacitance		14		pF	Per Output
$Z_{OUT}$	Output Impedance		12		$\Omega$	
$I_{CC}$	Maximum Quiescent Supply Current		0.5		mA	

**Table 5. AC Characteristics** ( $T_A = 0^\circ$  to  $70^\circ\text{C}$ ,  $V_{CCI} = 3.3\text{V} \pm 5\%$ ,  $V_{CCO} = 3.3\text{V} \pm 5\%$ )

Symbol	Characteristic	Min	Typ	Max	Unit	Condition
$F_{max}$	Maximum Frequency			250	MHz	
$t_{PLH}$	Propagation Delay	1.3		2.3	ns	Note 1
$t_{sk(o)}$	Output-to-Output Skew			200	ps	
$t_{sk(pr)}$	Part-to-Part Skew			1.0	ns	Notes 1, 2
$t_{sk(pr)}$	Part-to-Part Skew			500	ps	Notes 1, 3
$d_t$	Duty Cycle	45		55	%	
$t_r, t_f$	Output Rise/Fall Time	0.2		1.0	ns	

1. Tested using standard input levels, production tested @ 133 MHz.
2. Across temperature and voltage ranges, includes output skew.
3. For a specific temperature and voltage, includes output skew.

PACKAGE DIMENSIONS

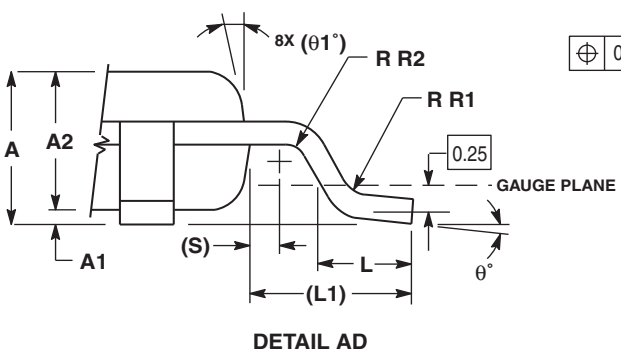
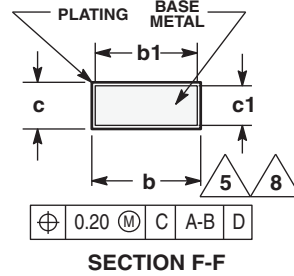
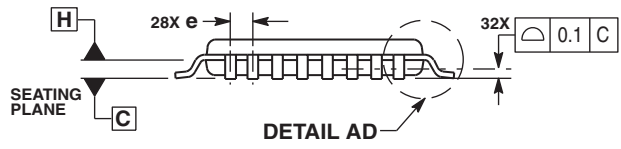
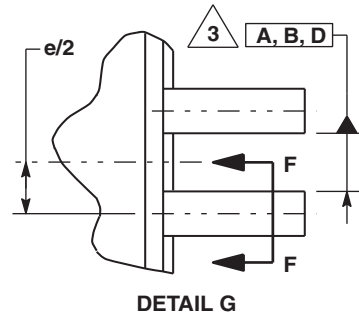
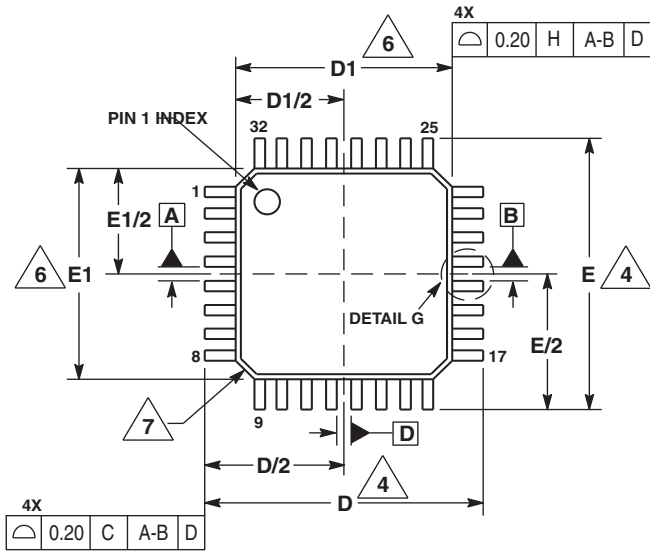

- NOTES:
1. DIMENSIONS ARE IN MILLIMETERS.
  2. INTERPRET DIMENSIONS AND TOLERANCES PER ASME Y14.5M, 1994.
  3. DATUMS A, B, AND D TO BE DETERMINED AT DATUM PLANE H.
  4. DIMENSIONS D AND E TO BE DETERMINED AT SEATING PLANE C.
  5. DIMENSION b DOES NOT INCLUDE DAMBAR PROTRUSION. ALLOWABLE DAMBAR PROTRUSION SHALL NOT CAUSE THE LEAD WIDTH TO EXCEED THE MAXIMUM b DIMENSION BY MORE THAN 0.08-mm. DAMBAR CANNOT BE LOCATED ON THE LOWER RADIUS OR THE FOOT. MINIMUM SPACE BETWEEN PROTRUSION AND ADJACENT LEAD OR PROTRUSION: 0.07-mm.
  6. DIMENSIONS D1 AND E1 DO NOT INCLUDE MOLD PROTRUSION. ALLOWABLE PROTRUSION IS 0.25-mm PER SIDE. D1 AND E1 ARE MAXIMUM PLASTIC BODY SIZE DIMENSIONS INCLUDING MOLD MISMATCH.
  7. EXACT SHAPE OF EACH CORNER IS OPTIONAL.
  8. THESE DIMENSIONS APPLY TO THE FLAT SECTION OF THE LEAD BETWEEN 0.1-mm AND 0.25-mm FROM THE LEAD TIP.

DIM	MILLIMETERS	
	MIN	MAX
A	1.40	1.60
A1	0.05	0.15
A2	1.35	1.45
b	0.30	0.45
b1	0.30	0.40
c	0.09	0.20
c1	0.09	0.16
D	9.00	BSC
D1	7.00	BSC
e	0.80	BSC
E	9.00	BSC
E1	7.00	BSC
L	0.50	0.70
L1	1.00	REF
q	0°	7°
q1	12	REF
R1	0.08	0.20
R2	0.08	---
S	0.20	REF

CASE 873A-03  
ISSUE B  
LQFP PLASTIC PACKAGE

## Revision History Sheet

Rev	Table	Page	Description of Change	Date
2		1	NRND – Not Recommend for New Designs	1/8/13
2		1	Product Discontinuation Notice - PDN CQ-15-02	5/6/15
3		1	Obsolete per Product Discontinuation Notice - PDN CQ-15-02.	10/4/16



## IMPORTANT NOTICE AND DISCLAIMER

RENESAS ELECTRONICS CORPORATION AND ITS SUBSIDIARIES (“RENESAS”) PROVIDES TECHNICAL SPECIFICATIONS AND RELIABILITY DATA (INCLUDING DATASHEETS), DESIGN RESOURCES (INCLUDING REFERENCE DESIGNS), APPLICATION OR OTHER DESIGN ADVICE, WEB TOOLS, SAFETY INFORMATION, AND OTHER RESOURCES “AS IS” AND WITH ALL FAULTS, AND DISCLAIMS ALL WARRANTIES, EXPRESS OR IMPLIED, INCLUDING, WITHOUT LIMITATION, ANY IMPLIED WARRANTIES OF MERCHANTABILITY, FITNESS FOR A PARTICULAR PURPOSE, OR NON-INFRINGEMENT OF THIRD PARTY INTELLECTUAL PROPERTY RIGHTS.

These resources are intended for developers skilled in the art designing with Renesas products. You are solely responsible for (1) selecting the appropriate products for your application, (2) designing, validating, and testing your application, and (3) ensuring your application meets applicable standards, and any other safety, security, or other requirements. These resources are subject to change without notice. Renesas grants you permission to use these resources only for development of an application that uses Renesas products. Other reproduction or use of these resources is strictly prohibited. No license is granted to any other Renesas intellectual property or to any third party intellectual property. Renesas disclaims responsibility for, and you will fully indemnify Renesas and its representatives against, any claims, damages, costs, losses, or liabilities arising out of your use of these resources. Renesas' products are provided only subject to Renesas' Terms and Conditions of Sale or other applicable terms agreed to in writing. No use of any Renesas resources expands or otherwise alters any applicable warranties or warranty disclaimers for these products.

(Rev.1.0 Mar 2020)

### Corporate Headquarters

TOYOSU FORESIA, 3-2-24 Toyosu,  
Koto-ku, Tokyo 135-0061, Japan  
[www.renesas.com](http://www.renesas.com)

### Contact Information

For further information on a product, technology, the most up-to-date version of a document, or your nearest sales office, please visit:  
[www.renesas.com/contact/](http://www.renesas.com/contact/)

### Trademarks

Renesas and the Renesas logo are trademarks of Renesas Electronics Corporation. All trademarks and registered trademarks are the property of their respective owners.