

## High Voltage Ultrafast Rectifier

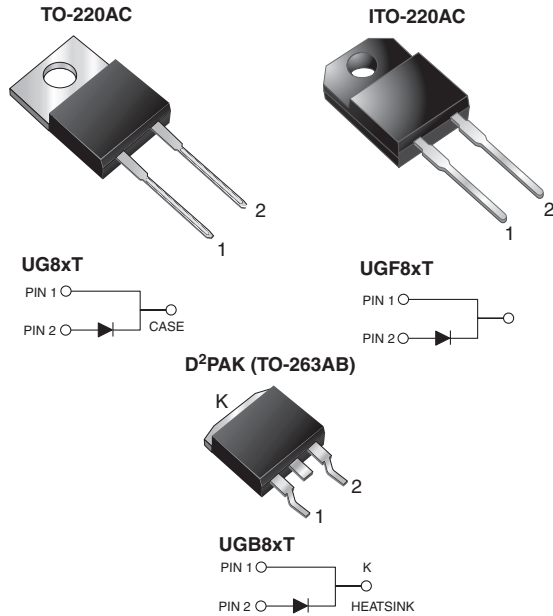

### FEATURES

- Power pack
- Glass passivated chip junction
- Ultrafast recovery time
- Soft recovery characteristics
- Low switching losses, high efficiency
- High forward surge capability
- Meets MSL level 1, per J-STD-020, LF maximum peak of 245 °C (for D<sup>2</sup>PAK (TO-263AB package))
- Solder dip 275 °C max., 10 s per JESD 22-B106 (for TO-220AC and ITO-220AC package)
- AEC-Q101 qualified available
  - Automotive ordering code: base P/NHE3 (for ITO-220AC and D<sup>2</sup>PAK (TO-263AB package))
- Material categorization: for definitions of compliance please see [www.vishay.com/doc?99912](http://www.vishay.com/doc?99912)



RoHS  
COMPLIANT

### TYPICAL APPLICATIONS

For use in high voltage and high frequency power factor correction application.

### MECHANICAL DATA

**Case:** TO-220AC, ITO-220AC, D<sup>2</sup>PAK (TO-263AB)

Molding compound meets UL 94V-0 flammability rating  
 Base P/N-E3 - RoHS-compliant, commercial grade  
 Base P/NHE3\_X - RoHS-compliant and AEC-Q101 qualified ("\_X" denotes revision code e.g. A, B,...)

**Terminals:** matte tin plated leads, solderable per J-STD-002 and JESD22-B102

E3 suffix meets JESD 201 class 1A whisker test, HE3 suffix meets JESD 201 class 2 whisker test

**Polarity:** as marked

**Mounting Torque:** 10 in-lbs max.

### DESIGN SUPPORT TOOLS AVAILABLE



PRIMARY CHARACTERISTICS	
$I_{F(AV)}$	8.0 A
$V_{RRM}$	500 V to 600 V
$I_{FSM}$	100 A
$t_{rr}$	25 ns
$t_{fr}$	500 ns
$V_F$ at $I_F = 8$ A	1.5 V
$T_J$ max.	150 °C
Package	TO-220AC, ITO-220AC, D <sup>2</sup> PAK (TO-263AB)
Circuit configuration	Single

MAXIMUM RATINGS ( $T_C = 25$ °C unless otherwise noted)				
PARAMETER	SYMBOL	UG8HT	UG8JT	UNIT
Max. repetitive peak reverse voltage	$V_{RRM}$	500	600	V
Max. working reverse voltage	$V_{RWM}$	400	480	V
Max. RMS voltage	$V_{RMS}$	350	420	V
Max. DC blocking voltage	$V_{DC}$	500	600	V
Max. average forward rectified current	$I_{F(AV)}$	8.0		A
Peak forward surge current 8.3 ms single half sine-wave superimposed on rated load	$I_{FSM}$	100		A
Operating junction and storage temperature range	$T_J, T_{STG}$	-55 to +150		°C
Isolation voltage (ITO-220AB only) from terminals to heatsink $t = 1$ min	$V_{AC}$	1500		V



ELECTRICAL CHARACTERISTICS ( $T_C = 25\text{ }^\circ\text{C}$ unless otherwise noted)							
PARAMETER	TEST CONDITIONS		SYMBOL	UG8HT	UG8JT	UNIT	
Max. instantaneous forward voltage <sup>(1)</sup>	$I_F = 8\text{ A}$	$T_J = 25\text{ }^\circ\text{C}$	$V_F$	1.75		V	
	$I_F = 8\text{ A}$	$T_J = 125\text{ }^\circ\text{C}$		1.50			
Max. DC reverse current at $V_{RWM}$			$I_R$	$T_J = 25\text{ }^\circ\text{C}$		30	$\mu\text{A}$
				$T_J = 100\text{ }^\circ\text{C}$		800	$\mu\text{A}$
				$T_J = 125\text{ }^\circ\text{C}$		4.0	mA
Max. reverse recovery time	$I_F = 0.5\text{ A}, I_R = 1.0\text{ A}, I_{rr} = 0.25\text{ A}$		$t_{rr}$	25		ns	
	$I_F = 1.0\text{ A}, dI/dt = 50\text{ A}/\mu\text{s}, V_R = 30\text{ V}, I_{rr} = 0.1 I_{RM}$		$t_{rr}$	50		ns	
Typical softness factor ( $t_b/t_a$ )	$I_F = 8.0\text{ A}, dI/dt = 240\text{ A}/\mu\text{s}, V_R = 400\text{ V}, I_{rr} = 0.1 I_{RM}$		S	1.0		-	
Max. reverse recovery current	$I_F = 8.0\text{ A}, dI/dt = 64\text{ A}/\mu\text{s}, V_R = 400\text{ V}, T_C = 125\text{ }^\circ\text{C}$		$I_{RM}$	5.5		A	
	$I_F = 8.0\text{ A}, dI/dt = 240\text{ A}/\mu\text{s}, V_R = 400\text{ V}, T_C = 125\text{ }^\circ\text{C}$		$I_{RM}$	10		A	
Peak forward recovery time	$I_F = 8.0\text{ A}, dI/dt = 64\text{ A}/\mu\text{s}, V_F = 1.1 \times V_{F\text{ max.}}$		$t_{fr}$	500		ns	

**Note**(1) Pulse test: 300  $\mu\text{s}$  pulse width, 1 % duty cycle

THERMAL CHARACTERISTICS ( $T_C = 25\text{ }^\circ\text{C}$ unless otherwise noted)					
PARAMETER	SYMBOL	UG8	UGF	UGB8	UNIT
Typical thermal resistance from junction to case	$R_{\theta JC}$	2.2	5.0	2.2	$^\circ\text{C}/\text{W}$

ORDERING INFORMATION (Example)					
PACKAGE	PREFERRED P/N	UNIT WEIGHT (g)	PACKAGE CODE	BASE QUANTITY	DELIVERY MODE
TO-220AC	UG8JT-E3/45	1.80	45	50/tube	Tube
ITO-220AC	UGF8JT-E3/45	1.95	45	50/tube	Tube
D <sup>2</sup> PAK (TO-263AB)	UGB8JT-E3/45	1.33	45	50/tube	Tube
D <sup>2</sup> PAK (TO-263AB)	UGB8JT-E3/81	1.33	81	800/reel	Tape and reel
ITO-220AC	UGF8JT <sub>HE3</sub> _A/P <sup>(1)</sup>	1.95	P	50/tube	Tube
D <sup>2</sup> PAK (TO-263AB)	UGB8JT <sub>HE3</sub> _A/P <sup>(1)</sup>	1.33	P	50/tube	Tube
D <sup>2</sup> PAK (TO-263AB)	UGB8JT <sub>HE3</sub> _A/I <sup>(1)</sup>	1.33	I	800/reel	Tape and reel

**Note**(1) AEC-Q101 qualified available in ITO-220 and D<sup>2</sup>PAK (TO-263AB) package



### RATINGS AND CHARACTERISTICS CURVES ( $T_A = 25\text{ }^\circ\text{C}$ unless otherwise noted)

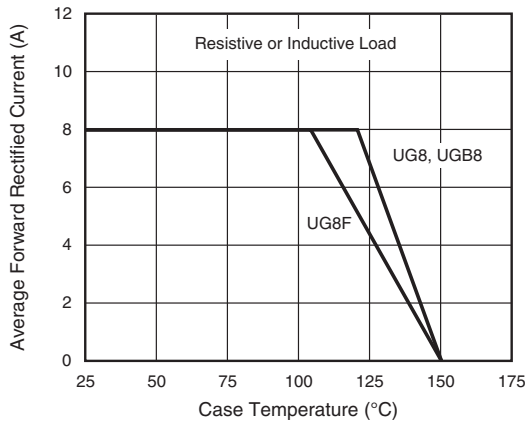

Fig. 1 - Max. Forward Current Derating Curve

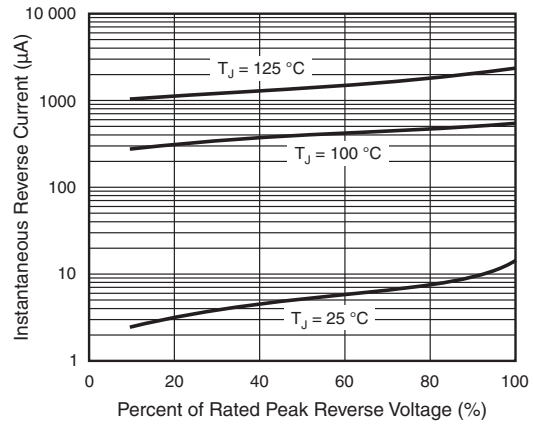

Fig. 4 - Typical Reverse Leakage Characteristics

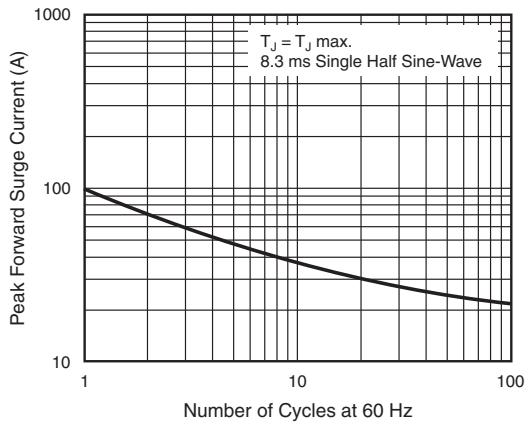

Fig. 2 - Max. Non-Repetitive Peak Forward Surge Current

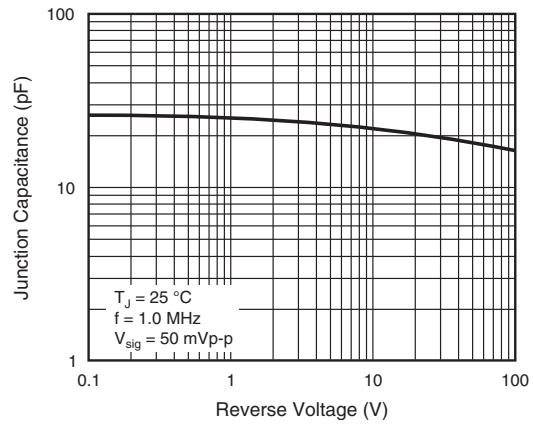

Fig. 5 - Typical Junction Capacitance

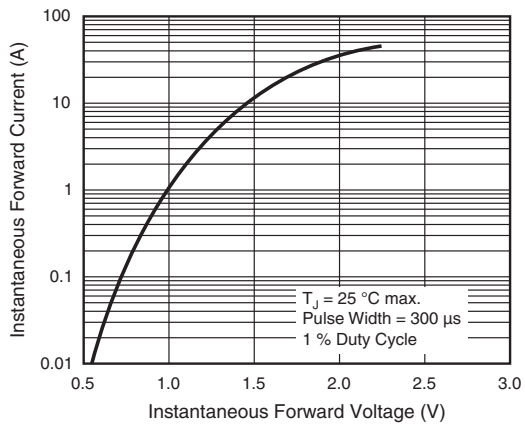

Fig. 3 - Typical Instantaneous Forward Characteristics

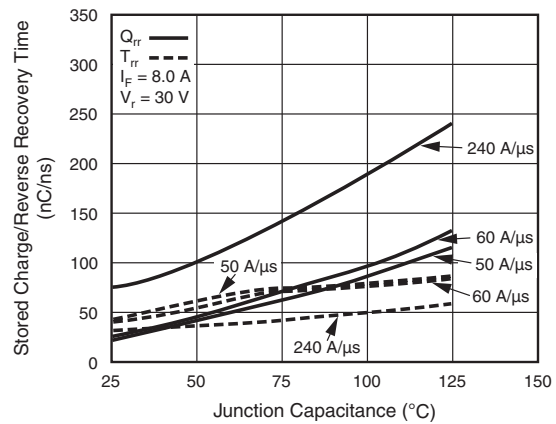
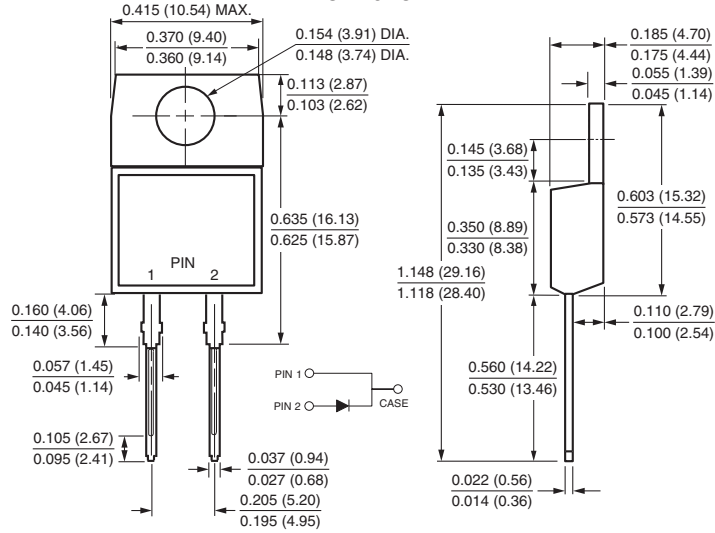

Fig. 6 - Reverse Switching Characteristics



### PACKAGE OUTLINE DIMENSIONS in inches (millimeters)

#### TO-220AC



#### ITO-220AC

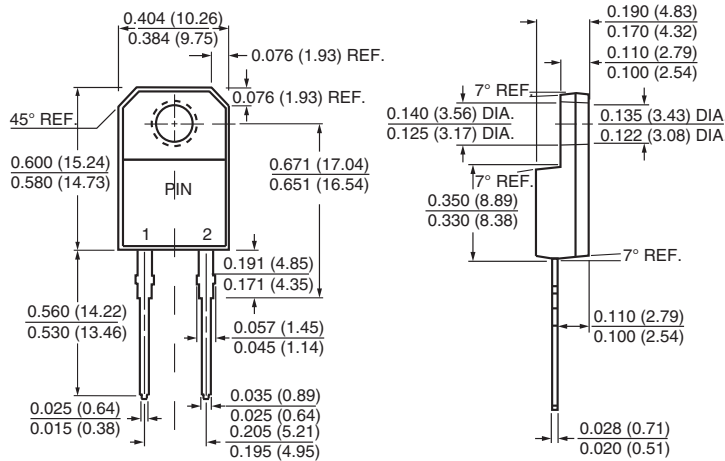

#### D<sup>2</sup>PAK (TO-263AB)

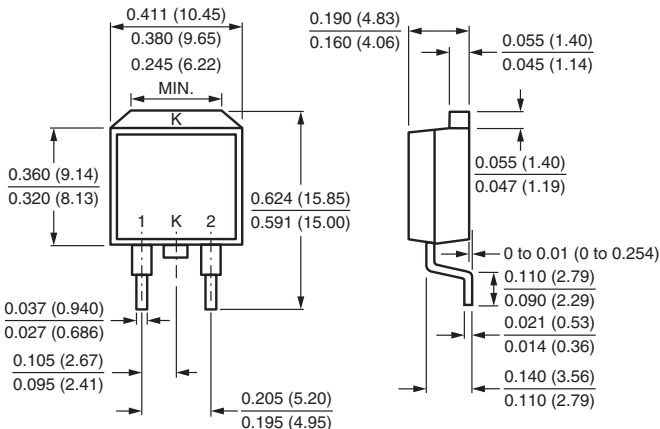

#### Mounting Pad Layout

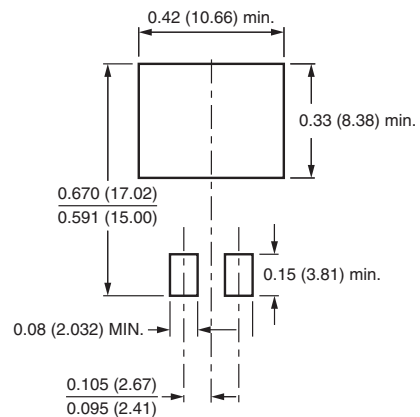



## Disclaimer

ALL PRODUCT, PRODUCT SPECIFICATIONS AND DATA ARE SUBJECT TO CHANGE WITHOUT NOTICE TO IMPROVE RELIABILITY, FUNCTION OR DESIGN OR OTHERWISE.

Vishay Intertechnology, Inc., its affiliates, agents, and employees, and all persons acting on its or their behalf (collectively, "Vishay"), disclaim any and all liability for any errors, inaccuracies or incompleteness contained in any datasheet or in any other disclosure relating to any product.

Vishay makes no warranty, representation or guarantee regarding the suitability of the products for any particular purpose or the continuing production of any product. To the maximum extent permitted by applicable law, Vishay disclaims (i) any and all liability arising out of the application or use of any product, (ii) any and all liability, including without limitation special, consequential or incidental damages, and (iii) any and all implied warranties, including warranties of fitness for particular purpose, non-infringement and merchantability.

Statements regarding the suitability of products for certain types of applications are based on Vishay's knowledge of typical requirements that are often placed on Vishay products in generic applications. Such statements are not binding statements about the suitability of products for a particular application. It is the customer's responsibility to validate that a particular product with the properties described in the product specification is suitable for use in a particular application. Parameters provided in datasheets and / or specifications may vary in different applications and performance may vary over time. All operating parameters, including typical parameters, must be validated for each customer application by the customer's technical experts. Product specifications do not expand or otherwise modify Vishay's terms and conditions of purchase, including but not limited to the warranty expressed therein.

Hyperlinks included in this datasheet may direct users to third-party websites. These links are provided as a convenience and for informational purposes only. Inclusion of these hyperlinks does not constitute an endorsement or an approval by Vishay of any of the products, services or opinions of the corporation, organization or individual associated with the third-party website. Vishay disclaims any and all liability and bears no responsibility for the accuracy, legality or content of the third-party website or for that of subsequent links.

Except as expressly indicated in writing, Vishay products are not designed for use in medical, life-saving, or life-sustaining applications or for any other application in which the failure of the Vishay product could result in personal injury or death. Customers using or selling Vishay products not expressly indicated for use in such applications do so at their own risk. Please contact authorized Vishay personnel to obtain written terms and conditions regarding products designed for such applications.

No license, express or implied, by estoppel or otherwise, to any intellectual property rights is granted by this document or by any conduct of Vishay. Product names and markings noted herein may be trademarks of their respective owners.