

**ISOTOP[®] Boost chopper
SiC MOSFET + SiC chopper diode
Power module**

$V_{DSS} = 1200V$
 $R_{DS(on)} = 34m\Omega \text{ max @ } T_j = 25^\circ C$
 $I_D = 71A \text{ @ } T_c = 25^\circ C$

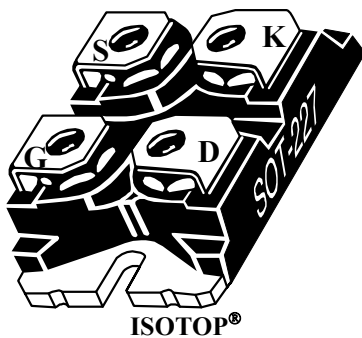
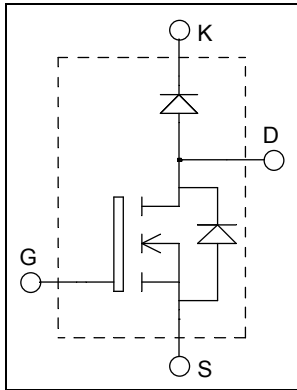

Application

- AC and DC motor control
- Switched Mode Power Supplies
- Power Factor Correction
- Brake switch

Features

- **SiC Power MOSFET**
 - Low $R_{DS(on)}$
 - High temperature performance
- **SiC Schottky Diode**
 - Zero reverse recovery
 - Zero forward recovery
 - Temperature Independent switching behavior
 - Positive temperature coefficient on VF
- ISOTOP[®] Package (SOT-227)
- Very low stray inductance
- High level of integration

Benefits

- Outstanding performance at high frequency operation
- Stable temperature behavior
- Very rugged
- Direct mounting to heatsink (isolated package)
- Low junction to case thermal resistance
- Easy paralleling due to positive TC of VCEsat
- RoHS Compliant

All ratings @ $T_j = 25^\circ C$ unless otherwise specified

Absolute maximum ratings

Symbol	Parameter	Max ratings	Unit
V_{DSS}	Drain - Source Breakdown Voltage	1200	V
I_D	Continuous Drain Current	$T_c = 25^\circ C$	71
		$T_c = 80^\circ C$	54
I_{DM}	Pulsed Drain current	140	
V_{GS}	Gate - Source Voltage	-10/+25	V
$R_{DS(on)}$	Drain - Source ON Resistance	34	m Ω
P_D	Maximum Power Dissipation	$T_c = 25^\circ C$ 300	W

CAUTION: These Devices are sensitive to Electrostatic Discharge. Proper Handling Procedures Should Be Followed. See application note APT0502 on www.microsemi.com

Electrical Characteristics

<i>Symbol</i>	<i>Characteristic</i>	<i>Test Conditions</i>	<i>Min</i>	<i>Typ</i>	<i>Max</i>	<i>Unit</i>
I_{DSS}	Zero Gate Voltage Drain Current	$V_{GS} = 0V, V_{DS} = 1200V$		12	100	μA
$R_{DS(on)}$	Drain – Source on Resistance	$V_{GS} = 20V$ $I_D = 50A$	$T_j = 25^\circ C$	25	34	m Ω
			$T_j = 150^\circ C$	43	63	
$V_{GS(th)}$	Gate Threshold Voltage	$V_{GS} = V_{DS}, I_D = 1mA$	1.9	2.3		V
I_{GSS}	Gate – Source Leakage Current	$V_{GS} = 20V, V_{DS} = 0V$			0.5	μA

Dynamic Characteristics

<i>Symbol</i>	<i>Characteristic</i>	<i>Test Conditions</i>	<i>Min</i>	<i>Typ</i>	<i>Max</i>	<i>Unit</i>
C_{iss}	Input Capacitance	$V_{GS} = 0V$ $V_{DS} = 1000V$ $f = 1MHz$		2980		pF
C_{oss}	Output Capacitance			220		
C_{rss}	Reverse Transfer Capacitance			23		
Q_g	Total gate Charge	$V_{GS} = 20V$ $V_{Bus} = 800V$ $I_D = 50A$		179		nC
Q_{gs}	Gate – Source Charge			32		
Q_{gd}	Gate – Drain Charge			63		
$T_{d(on)}$	Turn-on Delay Time	$V_{GS} = -2/+20V$ $V_{Bus} = 800V$ $I_D = 50A$ $R_L = 16\Omega ; R_G = 20\Omega$		21		ns
T_r	Rise Time			19		
$T_{d(off)}$	Turn-off Delay Time			50		
T_f	Fall Time			30		
E_{on}	Turn on Energy	Inductive Switching $V_{GS} = -5/+20V$ $V_{Bus} = 600V$ $I_D = 50A$ $R_G = 20\Omega$	$T_j = 150^\circ C$	1.1		mJ
E_{off}	Turn off Energy			$T_j = 150^\circ C$	0.6	
R_{thJC}	Junction to Case Thermal Resistance				0.42	$^\circ C/W$

SiC chopper diode ratings and characteristics

<i>Symbol</i>	<i>Characteristic</i>	<i>Test Conditions</i>	<i>Min</i>	<i>Typ</i>	<i>Max</i>	<i>Unit</i>
V_{RRM}	Maximum Peak Repetitive Reverse Voltage		1200			V
I_{RM}	Maximum Reverse Leakage Current	$V_R = 1200V$	$T_j = 25^\circ C$	64	400	μA
			$T_j = 175^\circ C$	112	2000	
I_F	DC Forward Current			20		A
V_F	Diode Forward Voltage	$I_F = 20A$	$T_j = 25^\circ C$	1.6	1.8	V
			$T_j = 175^\circ C$	2.3	3	
Q_C	Total Capacitive Charge	$I_F = 20A, V_R = 1200V$ $di/dt = 1000A/\mu s$		160		nC
C	Total Capacitance	$f = 1MHz, V_R = 200V$		192		pF
		$f = 1MHz, V_R = 400V$		138		
R_{thJC}	Junction to Case Thermal Resistance				0.8	$^\circ C/W$

Thermal and package characteristics

Symbol	Characteristic	Min	Typ	Max	Unit
R_{thJA}	Junction to Ambient (IGBT & Diode)			20	°C/W
V_{ISOL}	RMS Isolation Voltage, any terminal to case $t=1$ min, 50/60Hz	2500			V
T_{STG}	Storage Temperature Range	-40		150	°C
T_J	Operating junction temperature range	SiC MOSFET	-40	150	
		SiC diode	-40	175	
T_{JOP}	Recommended junction temperature under switching conditions	-40		T_{Jmax} -25	
Torque	Terminals and mounting screws			1.1	N.m
Wt	Package Weight		29.2		g

SOT-227 (ISOTOP®) Package Outline

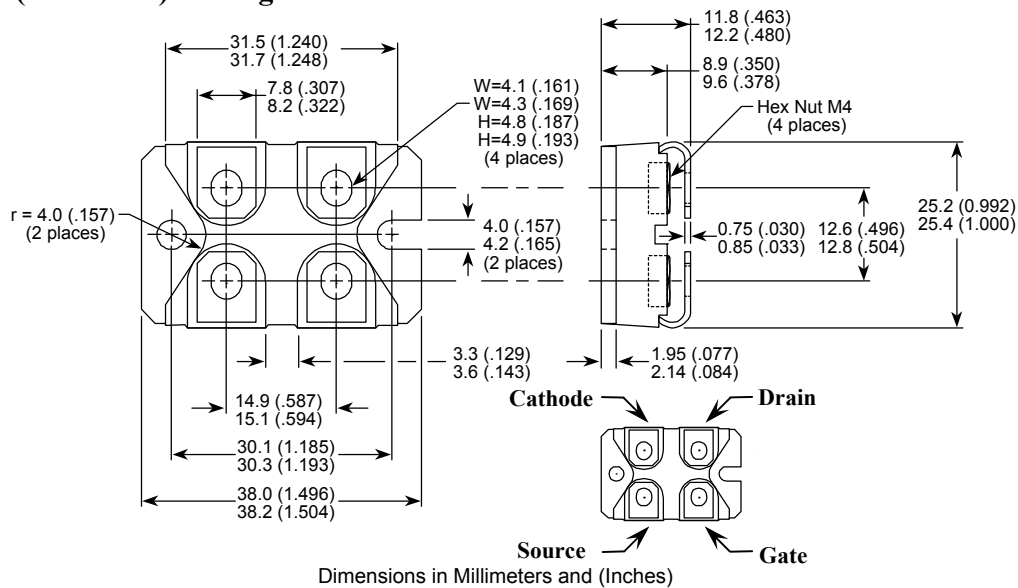

Typical Mosfet Performance Curve

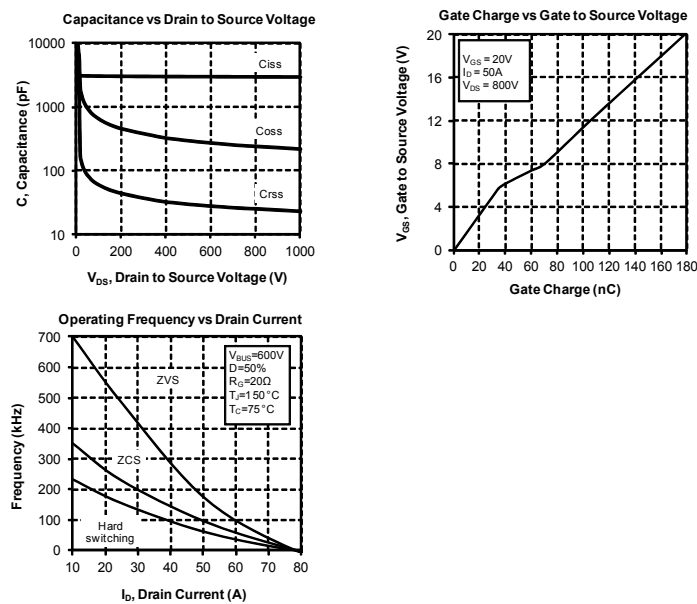

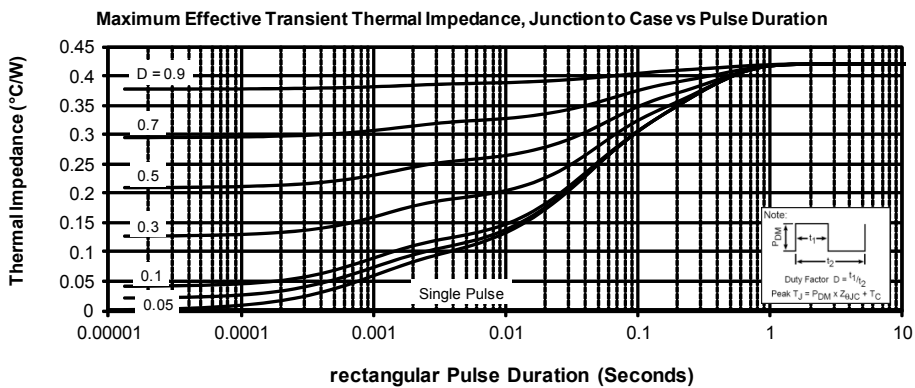
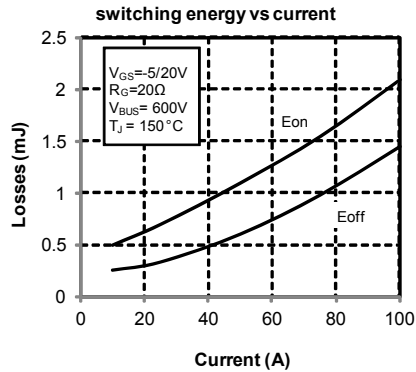
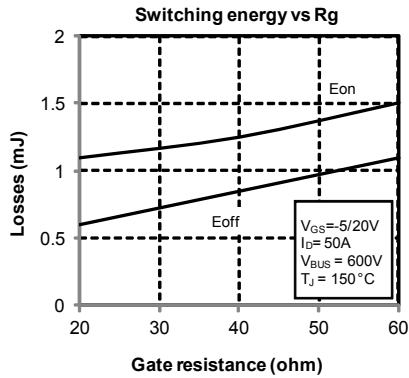
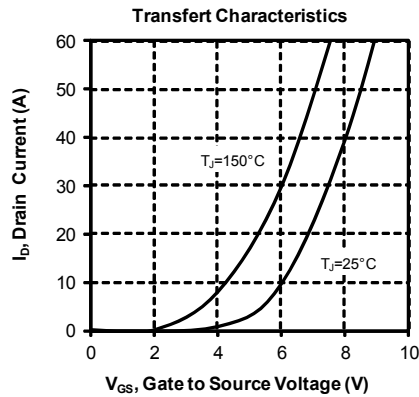
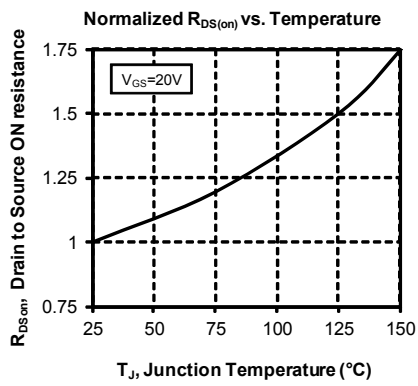
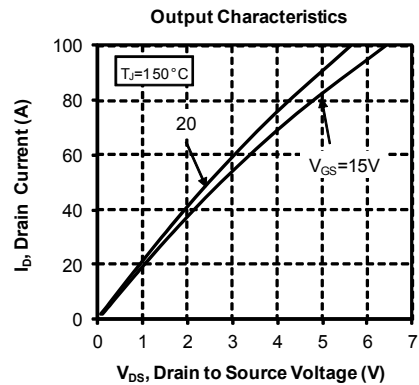
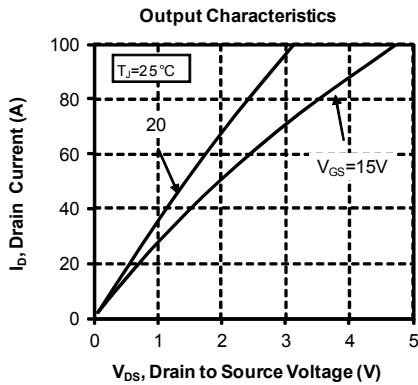

Typical SiC Diode Performance Curve

Maximum Effective Transient Thermal Impedance, Junction to Case vs Pulse Duration

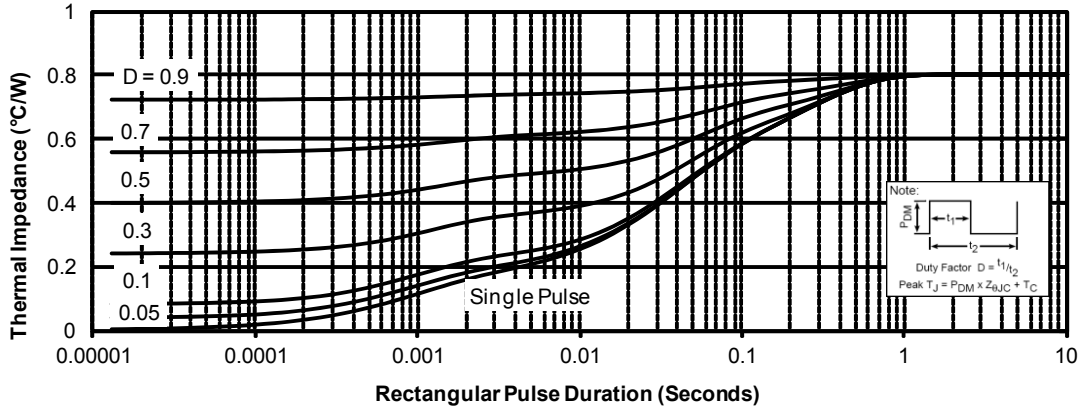

Forward Characteristics

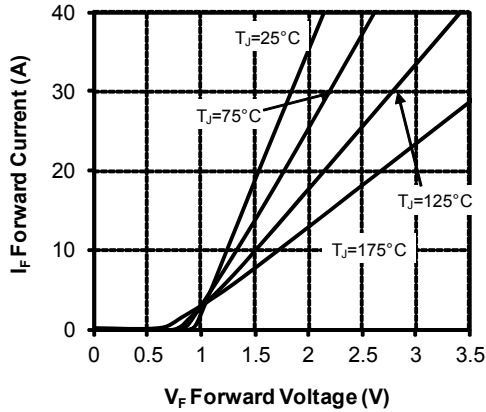

Reverse Characteristics

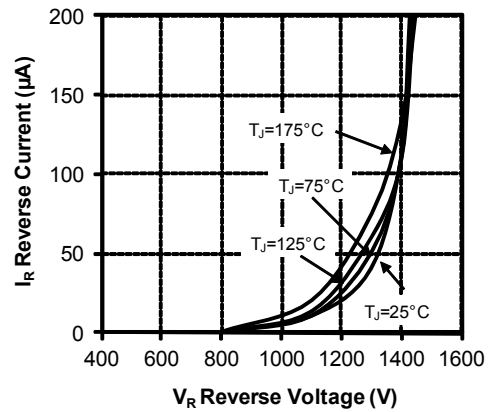

Capacitance vs. Reverse Voltage

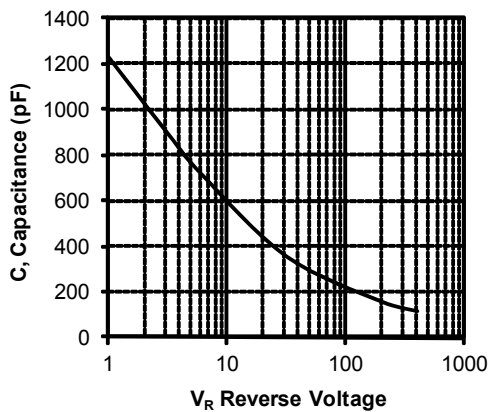

ISOTOP® is a registered trademark of ST Microelectronics NV

DISCLAIMER

The information contained in the document (unless it is publicly available on the Web without access restrictions) is PROPRIETARY AND CONFIDENTIAL information of Microsemi and cannot be copied, published, uploaded, posted, transmitted, distributed or disclosed or used without the express duly signed written consent of Microsemi. If the recipient of this document has entered into a disclosure agreement with Microsemi, then the terms of such Agreement will also apply. This document and the information contained herein may not be modified, by any person other than authorized personnel of Microsemi. No license under any patent, copyright, trade secret or other intellectual property right is granted to or conferred upon you by disclosure or delivery of the information, either expressly, by implication, inducement, estoppels or otherwise. Any license under such intellectual property rights must be approved by Microsemi in writing signed by an officer of Microsemi.

Microsemi reserves the right to change the configuration, functionality and performance of its products at anytime without any notice. This product has been subject to limited testing and should not be used in conjunction with life-support or other mission-critical equipment or applications. Microsemi assumes no liability whatsoever, and Microsemi disclaims any express or implied warranty, relating to sale and/or use of Microsemi products including liability or warranties relating to fitness for a particular purpose, merchantability, or infringement of any patent, copyright or other intellectual property right. Any performance specifications believed to be reliable but are not verified and customer or user must conduct and complete all performance and other testing of this product as well as any user or customers final application. User or customer shall not rely on any data and performance specifications or parameters provided by Microsemi. It is the customer's and user's responsibility to independently determine suitability of any Microsemi product and to test and verify the same. The information contained herein is provided "AS IS, WHERE IS" and with all faults, and the entire risk associated with such information is entirely with the User. Microsemi specifically disclaims any liability of any kind including for consequential, incidental and punitive damages as well as lost profit. The product is subject to other terms and conditions which can be located on the web at <http://www.microsemi.com/legal/tnc.asp>

Life Support Application

Seller's Products are not designed, intended, or authorized for use as components in systems intended for space, aviation, surgical implant into the body, in other applications intended to support or sustain life, or for any other application in which the failure of the Seller's Product could create a situation where personal injury, death or property damage or loss may occur (collectively "Life Support Applications").

Buyer agrees not to use Products in any Life Support Applications and to the extent it does it shall conduct extensive testing of the Product in such applications and further agrees to indemnify and hold Seller, and its officers, employees, subsidiaries, affiliates, agents, sales representatives and distributors harmless against all claims, costs, damages and expenses, and attorneys' fees and costs arising, directly or indirectly, out of any claims of personal injury, death, damage or otherwise associated with the use of the goods in Life Support Applications, even if such claim includes allegations that Seller was negligent regarding the design or manufacture of the goods.

Buyer must notify Seller in writing before using Seller's Products in Life Support Applications. Seller will study with Buyer alternative solutions to meet Buyer application specification based on Sellers sales conditions applicable for the new proposed specific part.