

RoHS 2.0

PIN NUMBER	SIGNAL NAME
PIN 1	Vbus
PIN 2	D-
PIN 3	D+
PIN 4	GND
PIN 5	StdA_SSRX-
PIN 6	StdA_SSRX+
PIN 7	GND_DRAIN
PIN 8	StdA_SSTX-
PIN 9	StdA_SSTX+
SHELL	GND

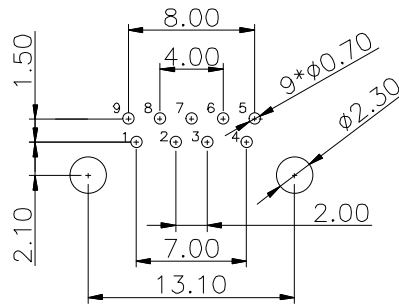
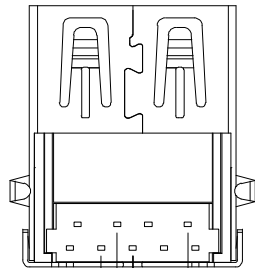
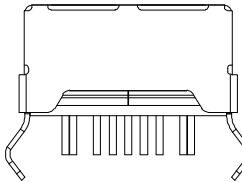
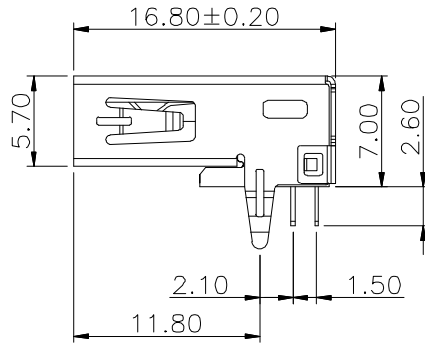
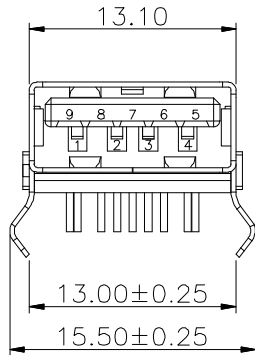
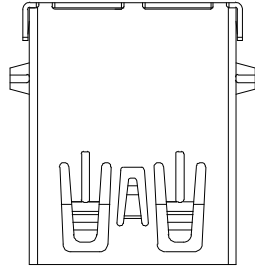
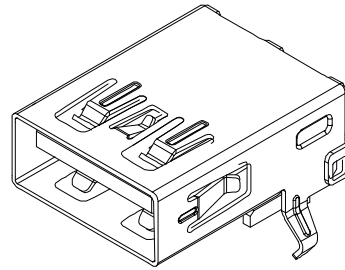

RECOMMENDER P. C. B. LAYOUT TOP VIEW
(COMPONENT SIDE TOLERANCE±0.05)

REV.	ECN NO.	DESCRIPTION	DATE	DESIGN
A1.	/.	重新核对图面	21.01.14	LiHui

NOTES:

- MATERIAL:
 - HOUSING: PBT ,COLOR IS BLUE;
 - CONTACT: BRASS (H65 T=0.20&0.25mm);
 - SHELL: COLD ROLLED IRON (SPCC T=0.30mm);
- ELECTRICAL:
 - VOLTAGE RATING: 30V DC ;
 - CURRENT RATING: 1.5A ;
 - CONTACT RESISTANCE: 30MILLIOHMS MAX.;
 - WITHSTAND VOLTAGE: 100V AC RMS 50(60)Hz,1MIN.;
 - INSULATION RESISTANCE: 100MEG OHMS MIN @500V DC;
- MECHANICAL:
 - MATING FORCE: 35N MAX.;
 - UNMATING FORCE: 5~35N ;
 - OPERATING LIFE: 1500 CYCLES MIN.;
- PLATING:
 - TERMINAL:
 - NI PLATING OVER ALL,
 - Tin PLATING ON SOLDER AREA,
 - Au G/Fu” ON CONTACT AREA;
 - SHELL: NI PLATING OVER ALL;
- ENVIRONMENTAL:
 - STORAGE TEMPERATURE RANGE: -40°C~+85°C;
 - OPERATION TEMPERATURE RANGE: -25°C~+70°C;

深圳市华灿天禄电子有限公司

UNLESS OTHERWISE, GENERAL TOLERANCE: X.xxx ±0.10 X.xx ±0.20 X.x ±0.30	NAME: 3.0 A母90° 弯脚平口		P/N:	
	THIRD ANGLE PROJECTION		DWC NO: HC-ST-003-01-Z	
ANGULAR: X.xx° ±1° X.x° ±3° X.° ±5°	UNIT: MM	SCALE: 1:1	SIZE: A4	SHEET: 1/1
DRAWN:		CHECKED:		APPROVED: