

»Features

- 550Watts peak pulse power ($t_p = 8/20\mu s$)
- Bidirectional configurations
- Solid-state silicon-avalanche technology
- Low clamping voltage
- Low leakage current
- IEC 61000-4-2 $\pm 30kV$ contact $\pm 30kV$ air
- IEC 61000-4-4 (EFT) 40A(5/50ns)
- IEC 61000-4-5 (Lightning) 45A(8/20 μs)

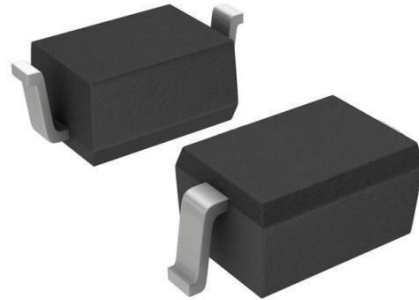

»Applications

- Microprocessor based equipment
- Personal Digital Assistants (PDA's)
- Notebooks, Desktops, and Servers
- Portable Instrumentation
- Pagers Peripherals

»Mechanical Data

- SOD323 package
- Molding compound flammability rating: UL94V-0
- Packaging: Tape and Reel
- RoHS/WEEE Compliant

»Schematic & PIN Configuration

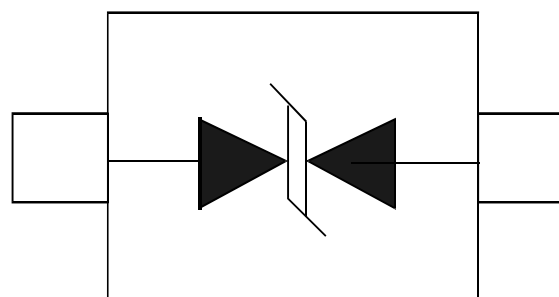

SOD-323

»Absolute Maximum Rating

Rating	Symbol	Value	Units
Peak Pulse Power ($t_p = 8/20\mu s$)	P_{PP}	550	Watts
Peak Pulse Current ($t_p = 8/20\mu s$)(note1)	I_{pp}	45	A
ESD per IEC 61000-4-2(Air) ESD per IEC 61000-4-2(Contact)	V_{ESD}	30 30	kV
Lead Soldering Temperature	T_L	260(10seconds)	$^{\circ}C$
Junction Temperature	T_J	-55 to + 150	$^{\circ}C$
Storage Temperature	T_{stg}	-55 to + 150	$^{\circ}C$

»Electrical Characteristics

Parameter	Symbol	Conditions	Min	Typical	Max	Units
Reverse Stand-Off Voltage	V_{RWM}				3.3	V
Reverse Breakdown Voltage	V_{BR}	$I_T = 1mA$	4.0	4.7		V
Reverse Leakage Current	I_R	$V_{RWM} = 3.3V, T = 25^{\circ}C$			0.5	μA
Clamping Voltage	V_C	$I_{PP} = 45A, t_p = 8/20\mu s$		12		V
Junction Capacitance	C_j	$V_R = 0V, f = 1MHz$		80		pF

»Electrical Parameters (TA = 25°C unless otherwise noted)

Symbol	Parameter
I_{PP}	Maximum Reverse Peak Pulse Current
V_C	Clamping Voltage @ I_{PP}
V_{RWM}	Working Peak Reverse Voltage
I_R	Maximum Reverse Leakage Current @ V_{RWM}
V_{BR}	Breakdown Voltage @ I_T
I_T	Test Current

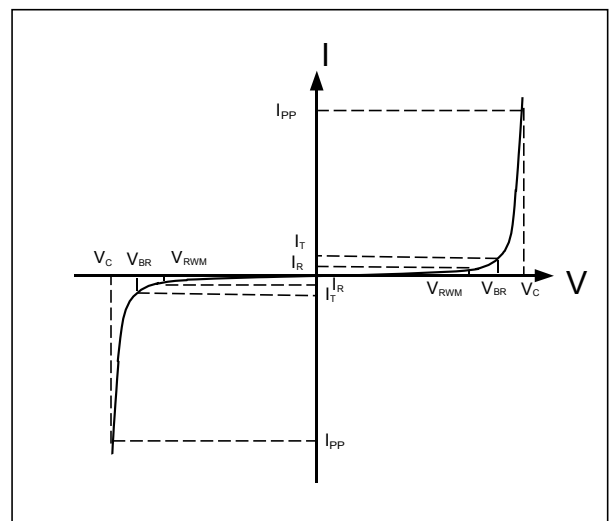

Note: 8/20 μs pulse waveform.

»Typical Characteristics

Figure 1: Peak Pulse Power vs. Pulse Time

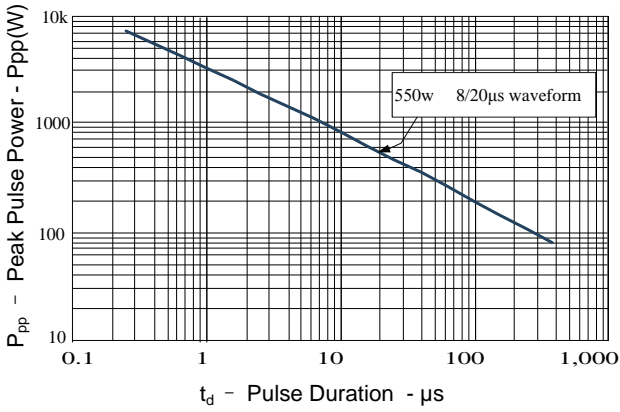

Figure 2: Power Derating Curve

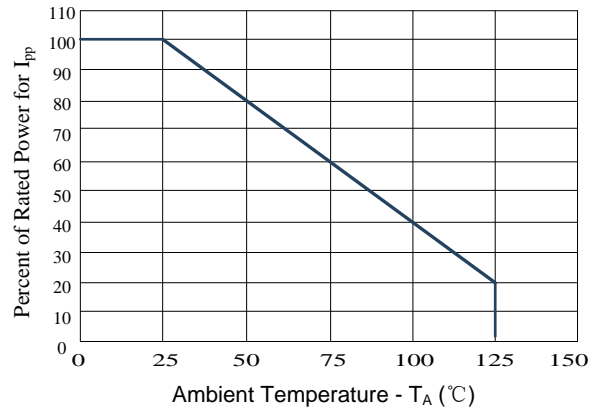

Figure3: Pulse Waveform

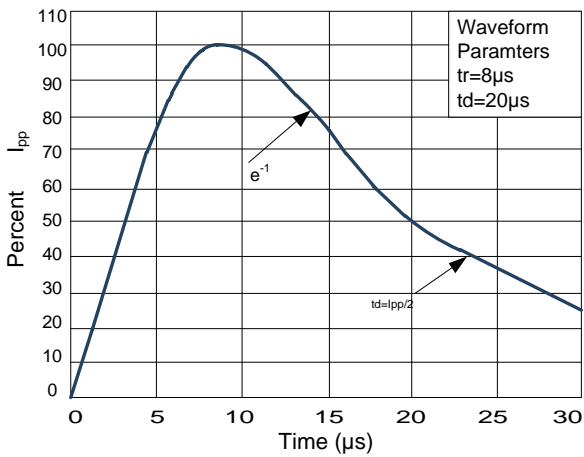
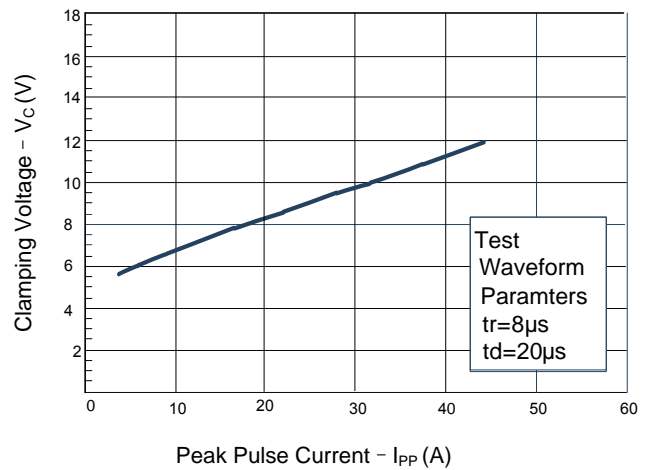
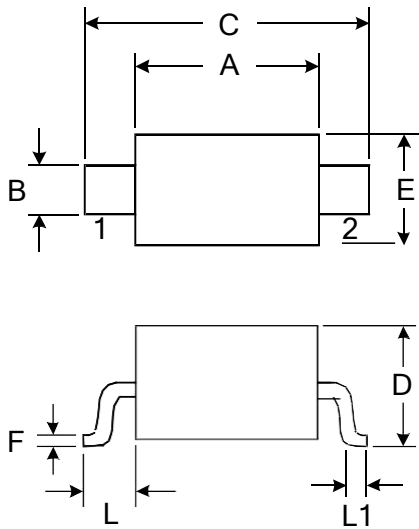

Figure 4: Clamping Voltage vs.Ipp



»Outline Drawing – SOD323



DIMENSIONS				
SYMBOL	MILLIMETER		INCHES	
	MIN	MAX	MIN	MAX
A	1.600	1.800	0.063	0.071
B	0.250	0.350	0.010	0.014
C	2.500	2.700	0.098	0.106
D		1.000		0.039
E	1.200	1.400	0.047	0.055
F	0.080	0.150	0.003	0.006
L	0.475 REF		0.019REF	
L1	0.250	0.400	0.010	0.016
H	0.000	0.100	0.000	0.004

»Marking

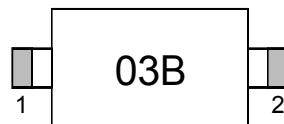

»Ordering information

Order code	Package	Base qty	Delivery mode
PSD03C-N	SOD323	3000	Tape and reel