



Surface Mount Superfast Recovery Rectifier
Reverse Voltage – 50 to 600 V
Forward Current –3 A

FEATURES

- For surface mounted applications
- Low profile package
- Glass Passivated Chip Junction
- Superfast reverse recovery time
- Lead free in comply with EU RoHS 2011/65/EU directives

MECHANICAL DATA

- Case : SMC
- Terminals: Solderable per MIL-STD-750, Method 2026
- Approx. Weight : 0.22g / 0.0077oz

PINNING

PIN	DESCRIPTION
1	Cathode
2	Anode

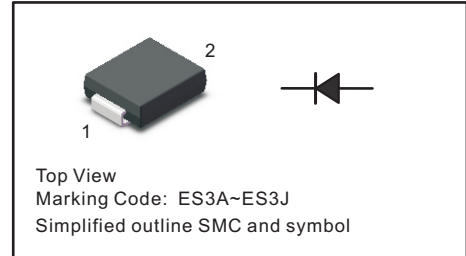

Absolute Maximum Ratings and Characteristics

Ratings at 25 °C ambient temperature unless otherwise specified. Single phase, half wave, 60 Hz, resistive or inductive load. For capacitive load, derate current by 20%.

Parameter	Symbols	ES3AC	ES3BC	ES3CC	ES3DC	ES3EC	ES3GC	ES3JC	Units
Maximum Repetitive Peak Reverse Voltage	V_{RRM}	50	100	150	200	300	400	600	V
Maximum RMS voltage	V_{RMS}	35	70	105	140	210	280	420	V
Maximum DC Blocking Voltage	V_{DC}	50	100	150	200	300	400	600	V
Maximum Average Forward Rectified Current at $T_c = 125\text{ }^\circ\text{C}$	$I_{F(AV)}$	3							A
Peak Forward Surge Current 8.3 ms Single Half Sine Wave Superimposed on Rated Load	I_{FSM}	90							A
Maximum Forward Voltage at 3 A	V_F	1				1.25		1.68	V
Maximum DC Reverse Current at Rated DC Blocking Voltage $T_a = 25\text{ }^\circ\text{C}$ $T_a = 125\text{ }^\circ\text{C}$	I_R	5 100							μA
Typical Junction Capacitance at $V_R=4\text{V}$, $f=1\text{MHz}$	C_j	40							pF
Maximum Reverse Recovery Time ⁽¹⁾	t_{rr}	35							ns
Typical Thermal Resistance ⁽²⁾	$R_{\theta JA}$ $R_{\theta JC}$	40 16							$^\circ\text{C/W}$
Operating and Storage Temperature Range	T_j, T_{stg}	-55 ~ +150							$^\circ\text{C}$

(1) Measured with $I_F = 0.5\text{ A}$, $I_R = 1\text{ A}$, $I_{rr} = 0.25\text{ A}$.

(2) P.C.B. mounted with 2.0" X 2.0" (5 X 5 cm) copper pad areas.



Fig.1 Reverse Recovery Time Characteristic And Test Circuit Diagram

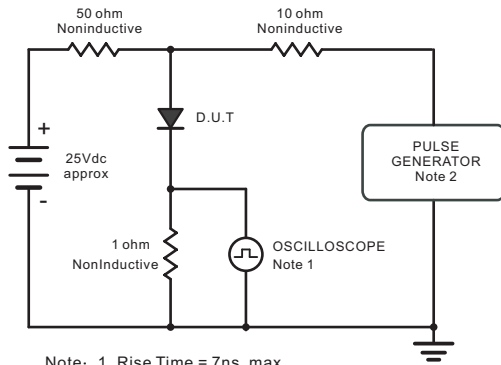

Note: 1. Rise Time = 7ns, max.
Input Impedance = 1megohm, 22pF.
2. Rises Time = 10ns, max.
Source Impedance = 50 ohms.

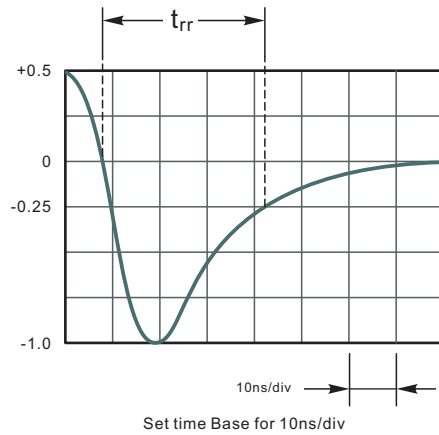

Fig.2 Maximum Average Forward Current Rating

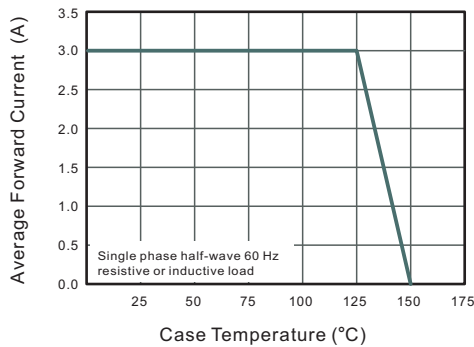

Fig.3 Typical Reverse Characteristics

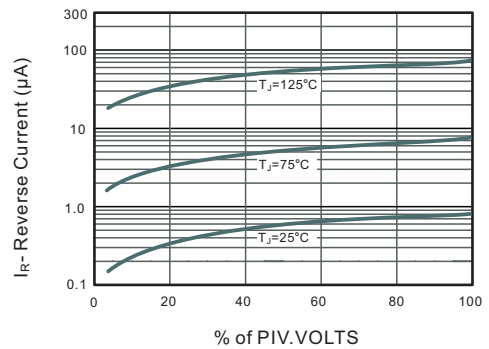

Fig.4 Typical Forward Characteristics

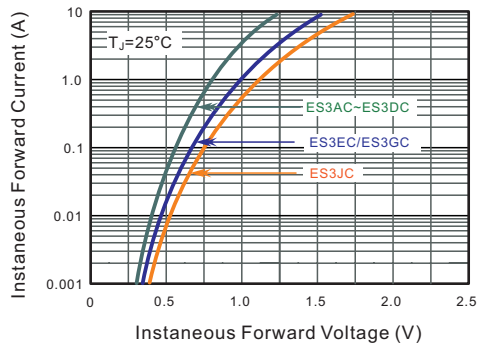

Fig.5 Typical Junction Capacitance

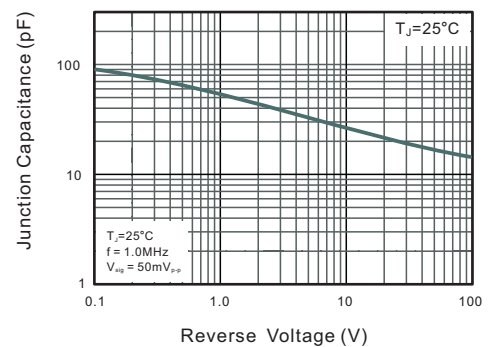
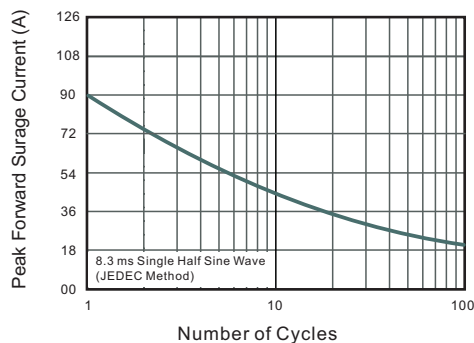

Fig.6 Maximum Non-Repetitive Peak Forward Surge Current





PACKAGE OUTLINE

Plastic surface mounted package; 2 leads

SMC

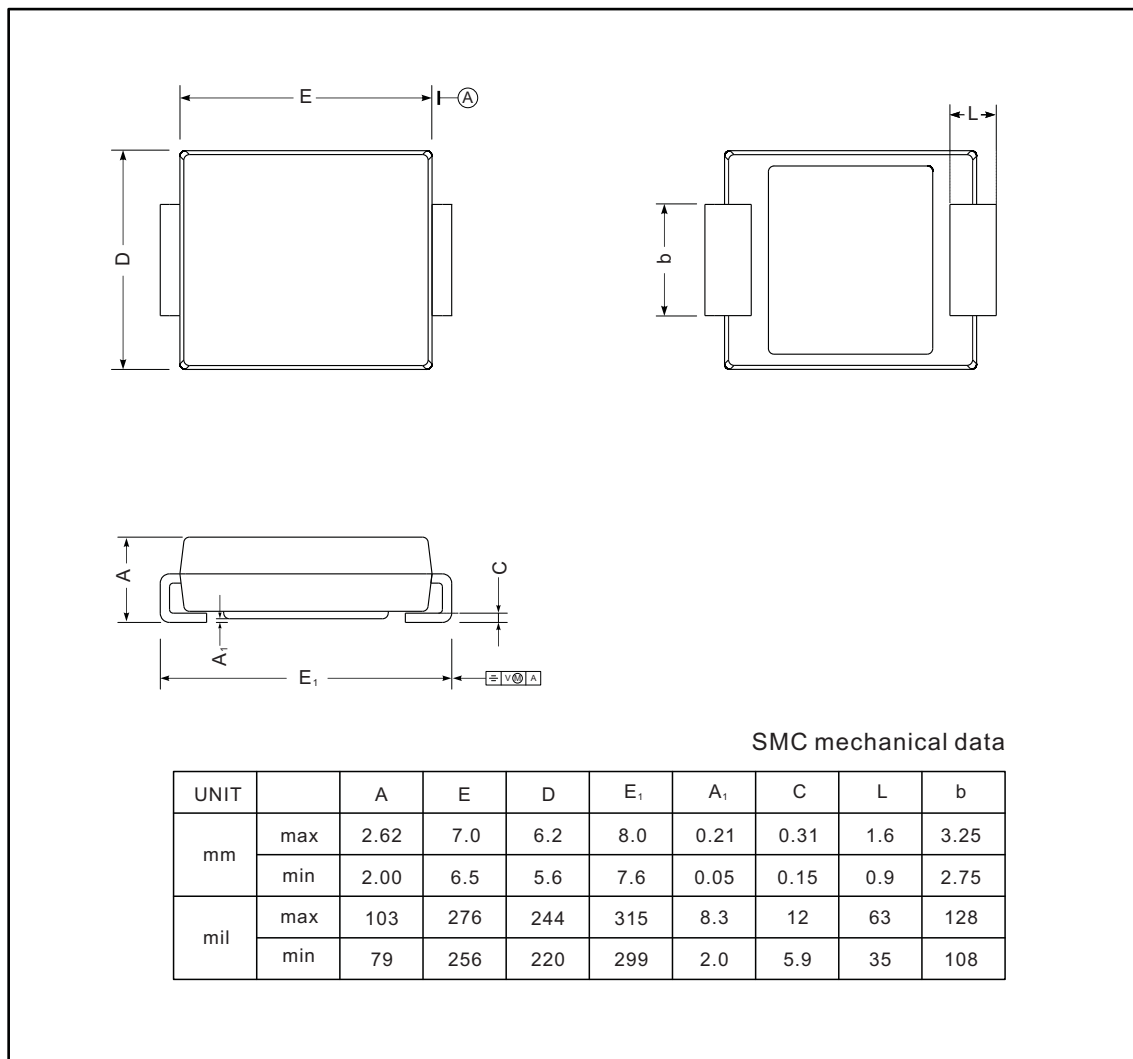

The recommended mounting pad size

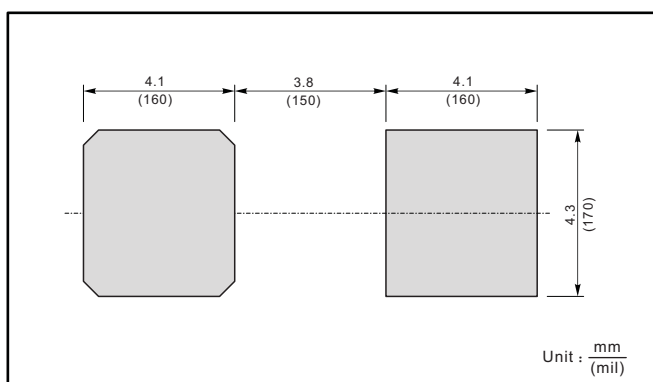

Marking

Type number	Marking code
ES3AC	ES3A
ES3BC	ES3B
ES3CC	ES3C
ES3DC	ES3D
ES3EC	ES3E
ES3GC	ES3G
ES3JC	ES3J