

Features

- Protects one data line
- Ultra low leakage: nA level
- Ultra low operating voltage: 3.3V
- Ultra low clamping voltage
- Complies with following standards:
 - IEC 61000-4-2 (ESD) immunity test
 - Air discharge: $\pm 30\text{kV}$
 - Contact discharge: $\pm 30\text{kV}$
 - IEC61000-4-4 (EFT) 40A (5/50ns)
 - IEC61000-4-5 (Lightning) 30A (8/20 μs)
- RoHS Compliant

Applications

- Cellular Handsets and Accessories
- Personal Digital Assistants
- Computer Interfaces Protection
- Control Signal Lines Protection
- Digital Cameras
- Peripherals
 - Audio Players
 - Keypads, Side Keys, LCD Displays

Mechanical Characteristics

- Package: DFN1006
- Lead Finish: NiPdAu
- Case Material: “Green” Molding Compound.
- UL Flammability Classification Rating 94V-0
- Moisture Sensitivity: Level 3 per J-STD-020
- Terminal Connections: See Diagram Below
- Marking Information: See Below

Absolute Maximum Ratings (T_{amb}=25°C unless otherwise specified)

Parameter	Symbol	Value	Unit
Peak Pulse Power (8/20 μs)	P _{pp}	300	W
ESD per IEC 61000-4-2 (Air)	V _{ESD}	± 30	Kv
ESD per IEC 61000-4-2 (Contact)		± 30	
Operating Temperature Range	T _J	-55 to +125	°C
Storage Temperature Range	T _{STJ}	-55 to +150	°C

Dimensions DFN1006

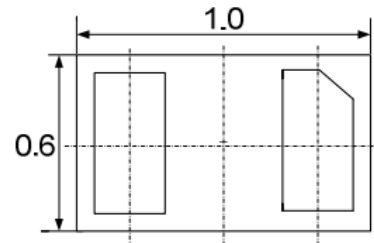

Pin Configuration

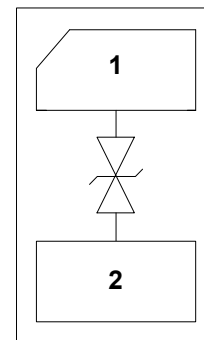

Electrical Characteristics (TA=25°C unless otherwise specified)

Part Number	Device Marking	V _{RWM} (V)	V _{BR} (V)	I _T (mA)	V _C @1A	V _C		I _R μA (Max)	C (Pf) (Typ.)
						(Max)	(@A)		
ESD3342C	38	3.3	3.5	50	5.5	10	30	50	40

Typical Performance Characteristics (T_A=25°C unless otherwise Specified)

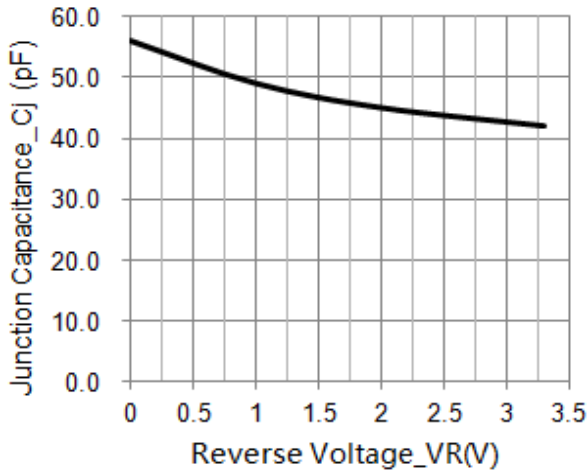

Junction Capacitance vs. Reverse Voltage

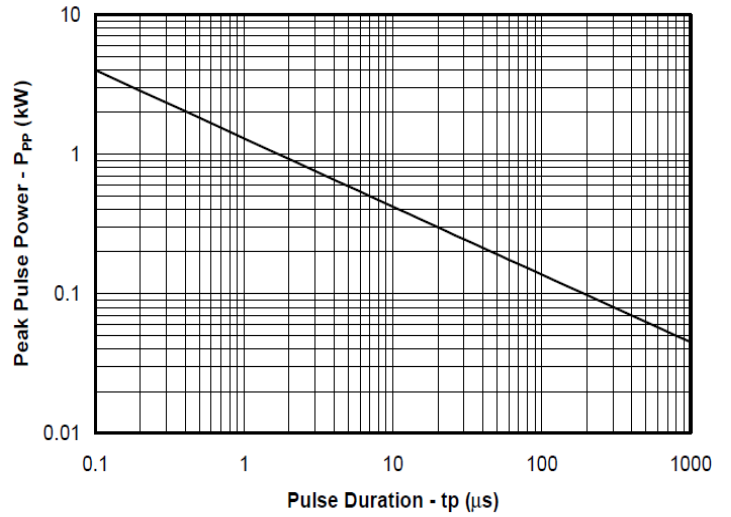

Peak Pulse Power vs. Pulse Time

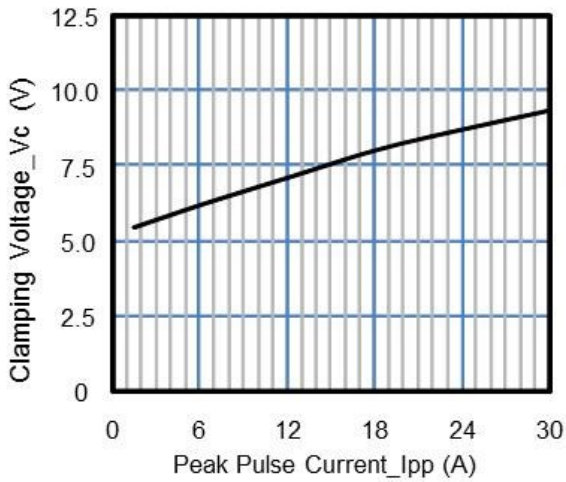

Clamping Voltage vs. Peak Pulse Current

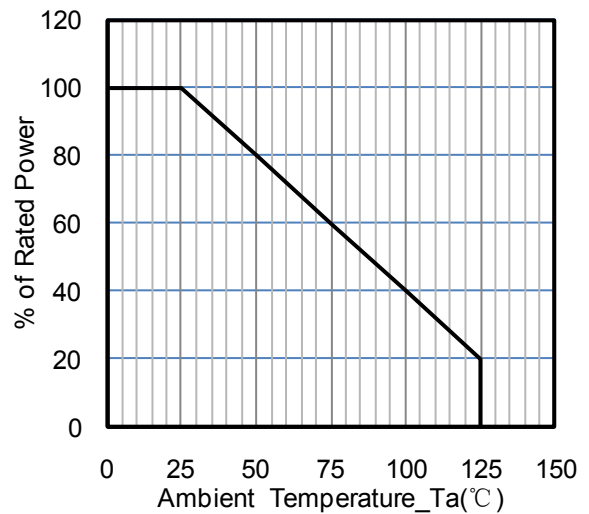

Power Derating Curve

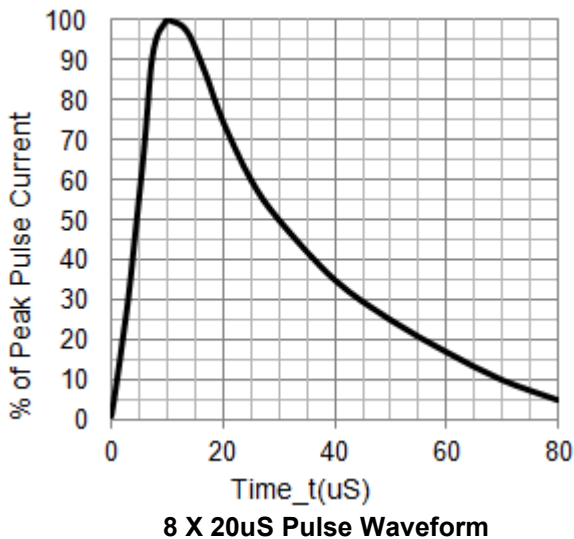

8 X 20uS Pulse Waveform

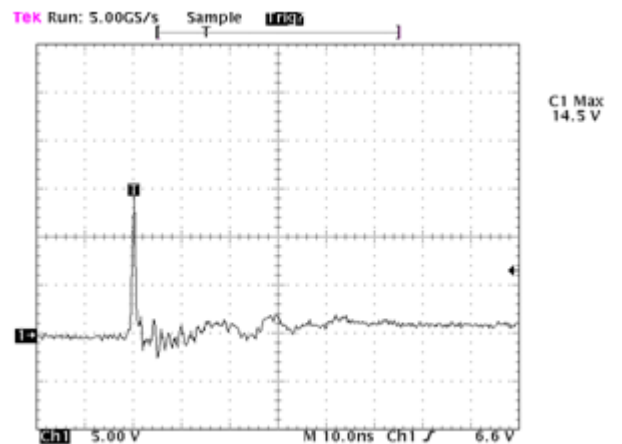

**ESD Clamping Voltage
8 kV Contact per IEC61000-4-2**

DFN1006 Package Outline Drawing

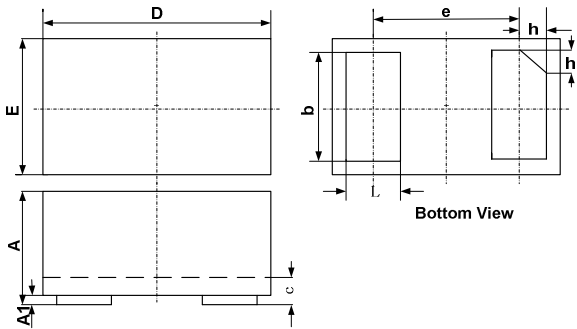

SYM	DIMENSIONS					
	MILLIMETERS			INCHES		
	MIN	NOM	MAX	MIN	NOM	MAX
A	0.45	0.50	0.55	0.018	0.020	0.022
A1	0.00	0.02	0.05	0.000	0.001	0.002
b	0.45	0.50	0.55	0.018	0.020	0.022
c	0.12	0.15	0.18	0.005	0.006	0.007
D	0.95	1.00	1.05	0.037	0.039	0.041
e	0.65 BSC			0.026 BSC		
E	0.55	0.60	0.65	0.022	0.024	0.026
L	0.20	0.25	0.30	0.008	0.010	0.012
h	0.07	0.12	0.17	0.003	0.005	0.007

Suggested Land Pattern

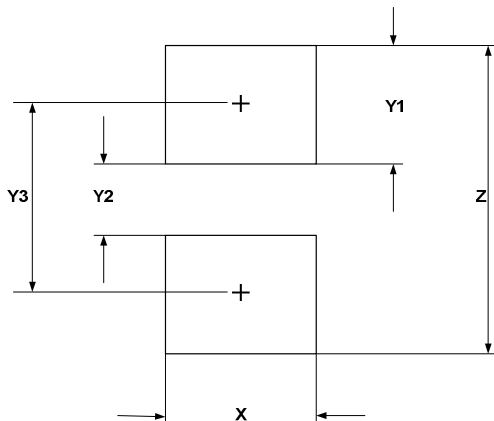

SYM	DIMENSIONS	
	MILLIMETERS	INCHES
X	0.60	0.024
Y1	0.50	0.020
Y2	0.30	0.012
Y3	0.80	0.032
Z	1.30	0.052