

### Features

- Ultra low leakage: nA level
- Operating voltage: 15V
- Low clamping voltage
- Complies with following standards:
  - IEC 61000-4-2 (ESD) immunity test
    - Air discharge:  $\pm 15\text{kV}$
    - Contact discharge:  $\pm 8\text{kV}$
  - IEC61000-4-4 (EFT) 40A (5/50ns)
- RoHS Compliant

### Dimensions SOT-23

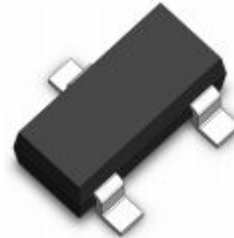

### Pin Configuration

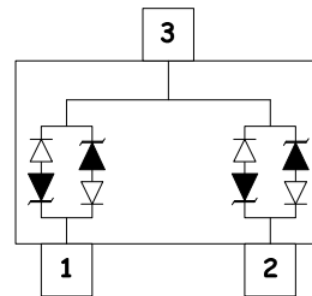

### Applications

- USB 2.0 power and data line
- Set-top box and digital TV
- Digital video interface (DVI)
- Notebook Computers
- SIM Ports
- 10/100 Ethernet

### Mechanical Characteristics

- Package: SOT-23
- Lead Finish: Lead Free
- UL Flammability Classification Rating 94V-0
- Quantity Per Reel: 3,000pcs
- Reel Size: 7inch

### Absolute Maximum Ratings (T<sub>amb</sub>=25°C unless otherwise specified)

Parameter	Symbol	Value	Unit
Peak Pulse Power (8/20 $\mu$ s)	P <sub>pp</sub>	180	W
ESD per IEC 61000-4-2 (Air)	V <sub>ESD</sub>	$\pm 15$	Kv
ESD per IEC 61000-4-2 (Contact)		$\pm 8$	
Operating Temperature Range	T <sub>J</sub>	-55 to +125	°C
Storage Temperature Range	T <sub>STJ</sub>	-55 to +150	°C

## Electrical Characteristics (TA=25°C unless otherwise specified)

Part Number	Device Marking	V <sub>RWM</sub> (V)	V <sub>BR</sub> (V)	I <sub>T</sub> (mA)	V <sub>C</sub> @1A	V <sub>C</sub>		I <sub>R</sub> μA (Max)	C (Pf) (Typ.)
						(Max)	(@A)		
LCC15DT3	BWC	15	16.7	1	24	40	4.5	1	1.5

## Characteristic Curves

Fig1. 8/20μs Pulse Waveform

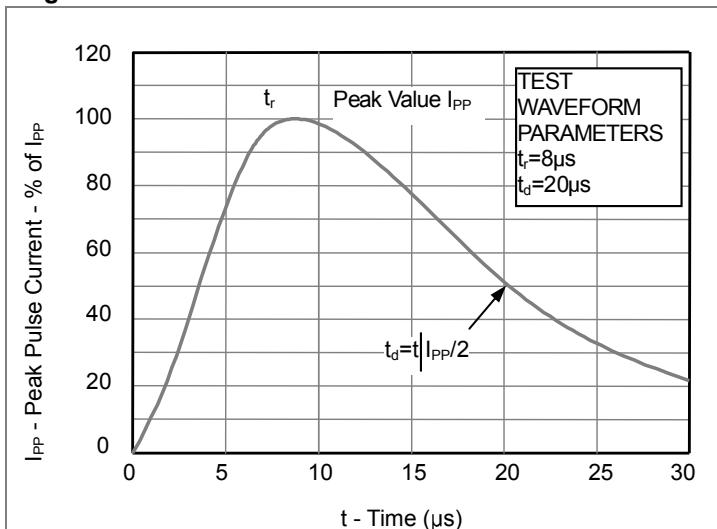

Fig2. ESD Pulse Waveform (according to IEC 61000-4-2)

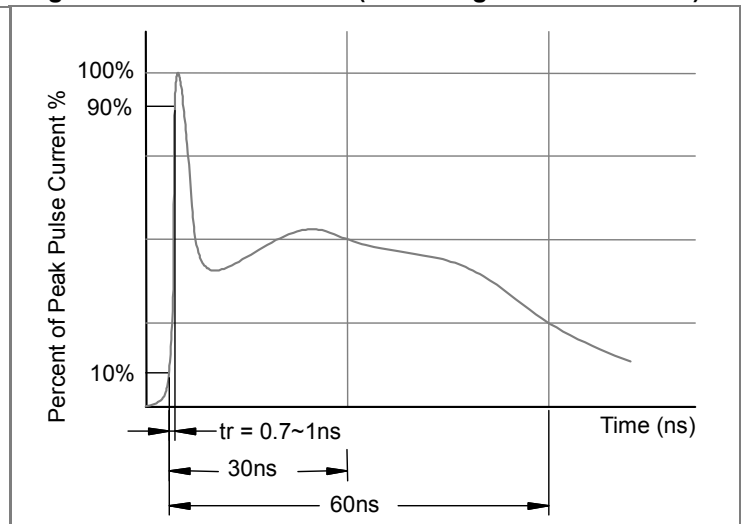
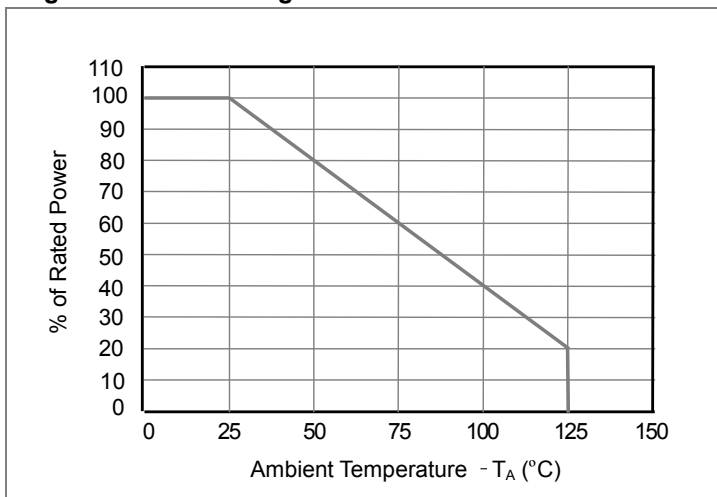
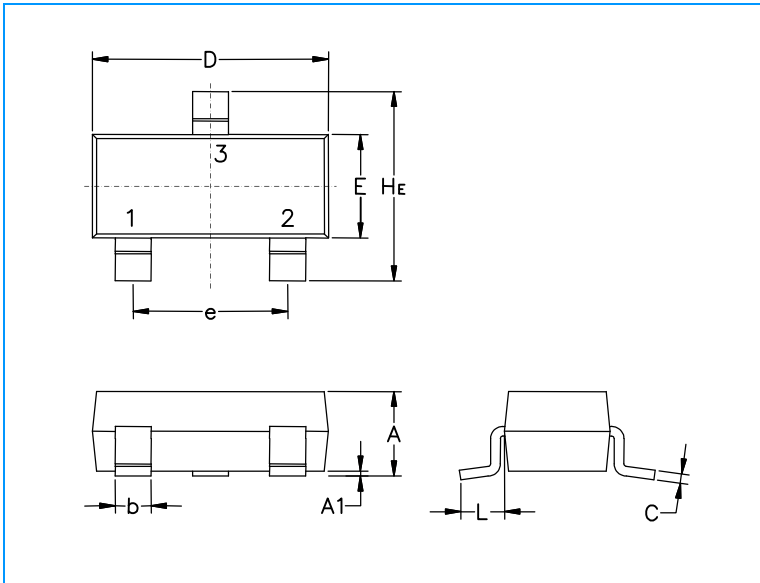

Fig3. Power Derating Curve



## SOT-23 Package Outline & Dimensions



Symbol	Millimeters			Inches		
	Min.	Nom.	Max.	Min.	Nom.	Max.
A	0.89	1.00	1.11	0.035	0.040	0.044
A1	0.01	0.06	0.10	0.001	0.002	0.004
b	0.37	0.44	0.50	0.15	0.18	0.020
c	0.09	0.13	0.18	0.003	0.005	0.007
D	2.80	2.90	3.04	0.110	0.114	0.120
E	1.20	1.30	1.40	0.047	0.051	0.055
e	1.78	1.90	2.04	0.070	0.075	0.081
L	0.35	0.54	0.69	0.014	0.021	0.029
He	2.10	2.40	2.64	0.083	0.094	0.104

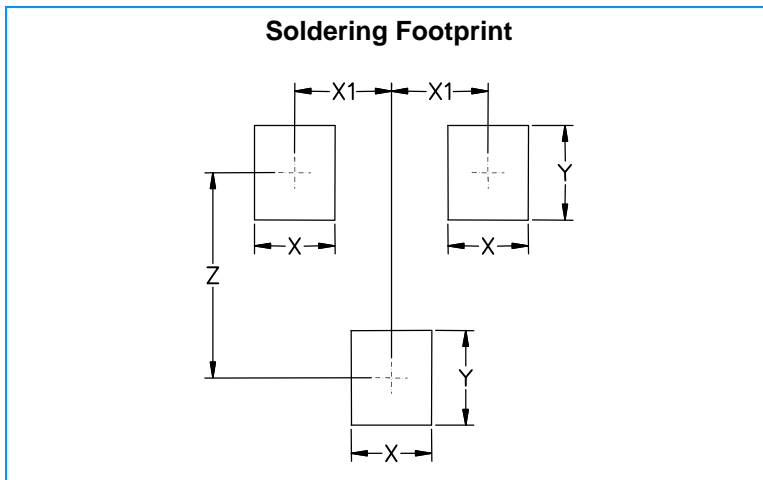

Symbol	Millimeters	Inches
X	0.80	0.031
X1	0.95	0.037
Y	0.90	0.035
Z	2.00	0.079