

LP2309LT1G

P-Channel 60V (D-S) MOSFET

1. FEATURES

- $R_{DS(ON)} \leq 215m\Omega$, $V_{GS} @ -10V$.
- $R_{DS(ON)} \leq 260m\Omega$, $V_{GS} @ -4.5V$.
- Super high density cell design for extremely low $R_{DS(ON)}$.
- Exceptional on-resistance and maximum DC current capability.
- We declare that the material of product compliance with RoHS requirements and Halogen Free.

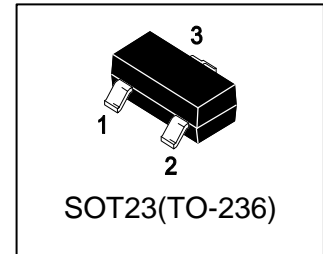

2. APPLICATIONS

- Power Management in Note book
- Portable Equipment
- Battery Powered System
- DC/DC Converter
- Load Switch
- DSC
- LCD Display inverter

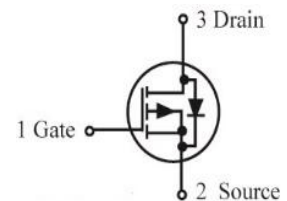

3. DEVICE MARKING AND ORDERING INFORMATION

Device	Marking	Shipping
LP2309LT1G	P09	3000/Tape&Reel
LP2309LT3G	P09	10000/Tape&Reel

4. MAXIMUM RATINGS($T_a = 25^\circ C$)

Parameter	Symbol	Limits	Unit
Drain–Source Voltage	VDSS	-60	V
Gate–to–Source Voltage – Continuous	VGS	± 20	V
Continuous Drain Current	ID	$T_a = 25^\circ C$	-1.9
		$T_a = 70^\circ C$	-1.5
Pulsed Drain Current	IDM	-7.6	A
Maximum Power Dissipation	PD	$T_a = 25^\circ C$	1.4
		$T_a = 70^\circ C$	0.9
Junction Temperature	Tj	150	$^\circ C$
Storage Temperature Range	Tstg	-55~+150	$^\circ C$
Thermal Resistance-Junction to Ambient(Note 1)	R θ JA	t \leq 10s	170
		Steady State	225
Thermal Resistance-Junction to Case(Note 1)	R θ JC	90	$^\circ C/W$

1.The device mounted on 1in² FR4 board with 2 oz copper

5. ELECTRICAL CHARACTERISTICS (Ta= 25°C)

Characteristic	Symbol	Min.	Typ.	Max.	Unit
STATIC					
Drain–Source Breakdown Voltage (VGS = 0, ID = -250μA)	VBRDSS	-60	-	-	V
Gate Threshold Voltage (VDS = VGS, ID = -250μA)	VGS(th)	-1	-	-3	V
Gate Leakage Current (VDS = 0V, VGS = ±20V)	IGSS	-	-	±100	nA
Zero Gate Voltage Drain Current (VGS = 0V, VDS = -60 V)	IDSS	-	-	-10	μA
Static Drain–Source On–State Resistance (VGS = -10 V, ID = -1.8 A) (VGS = -4.5 V, ID = -1.4 A)	RDS(on)	-	170 200	215 260	mΩ
Forward Voltage (VGS = 0 V, IS = -1.2 A)	VSD	-	-	-1.2	V
DYNAMIC					
Total Gate Charge (VGS = -4.5 V, ID = -1A, VDS = -48 V)	Qg	-	4.06	-	nC
Gate-Source Charge (VGS = -4.5 V, ID = -1A, VDS = -48 V)	Qgs	-	1.04	-	
Gate-Drain Charge (VGS = -4.5 V, ID = -1A, VDS = -48 V)	Qgd	-	2.1	-	
Input Capacitance (VGS = 0 V, f = 1.0MHz, VDS = -30 V)	Ciss	-	373	-	pF
Output Capacitance (VGS = 0 V, f = 1.0MHz, VDS = -30 V)	Coss	-	24.2	-	
Reverse Transfer Capacitance (VGS = 0 V, f = 1.0MHz, VDS = -30 V)	Crss	-	17.4	-	
Turn-On Delay Time	(VDS = -30V, RL = 30Ω ID = -1A, VGS = -10V RG = 3.1Ω)	td(on)	-	3.6	ns
Rise Time		tr	-	3.6	
Turn-Off Delay Time		td(off)	-	16.7	
Fall Time		tf	-	2.9	
Gate-Resistance (VGS = 0 V, VDS = 0V, f = 1MHz)	Rg	-	6.5	-	Ω

2. Pulse Test: Pulse Width ≤ 300 μs, Duty Cycle ≤ 2.0%.

6.ELECTRICAL CHARACTERISTICS CURVES

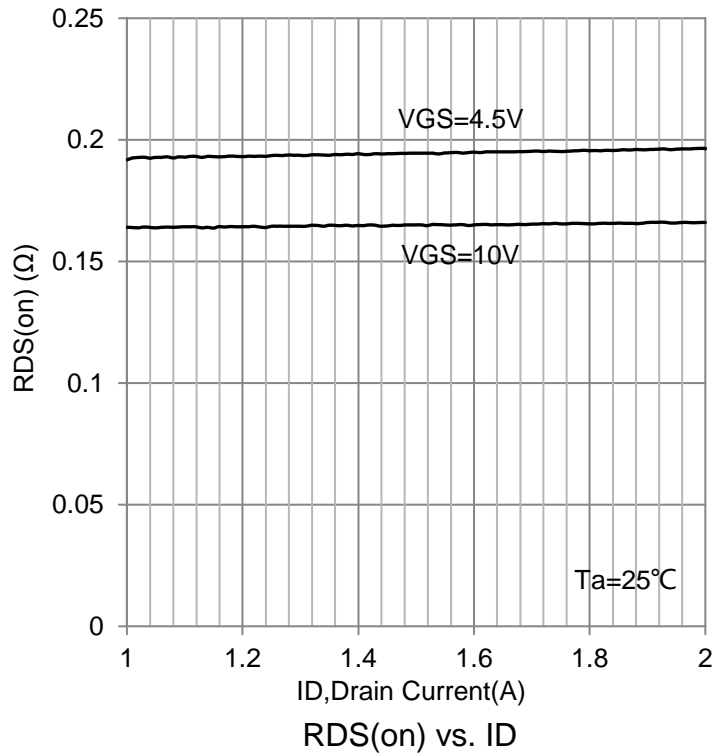
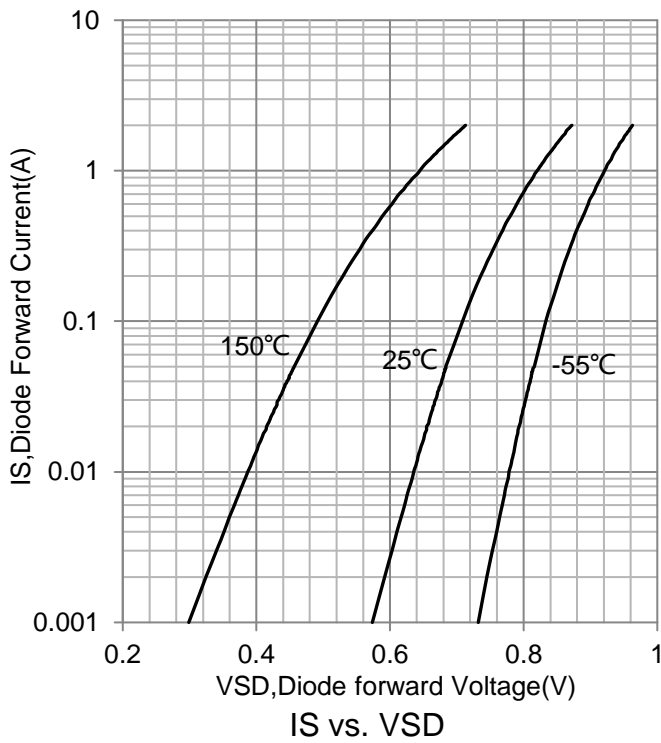
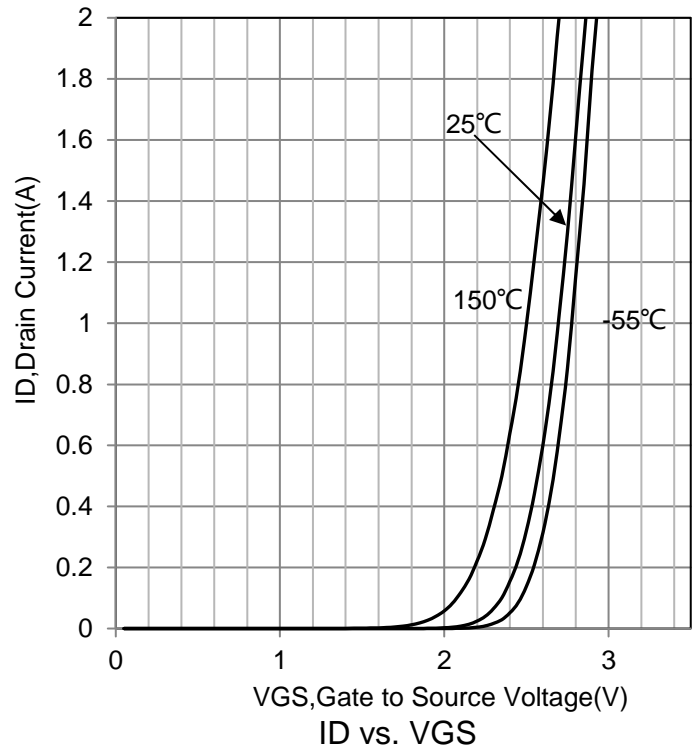
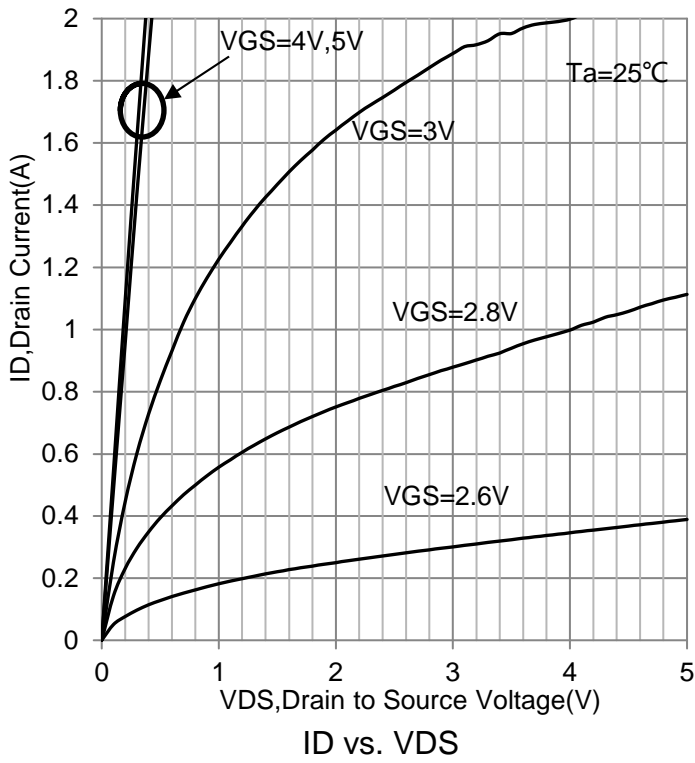

6.ELECTRICAL CHARACTERISTICS CURVES(Con.)

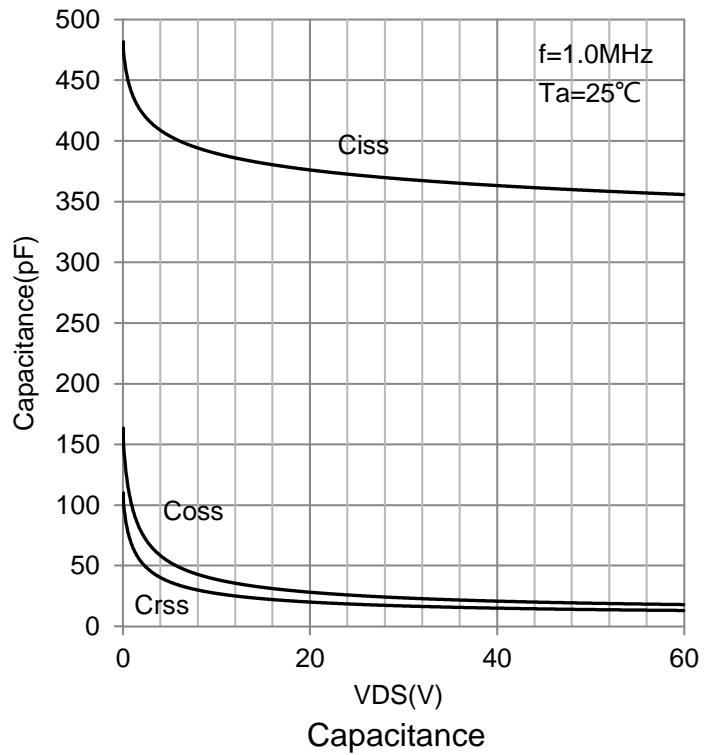
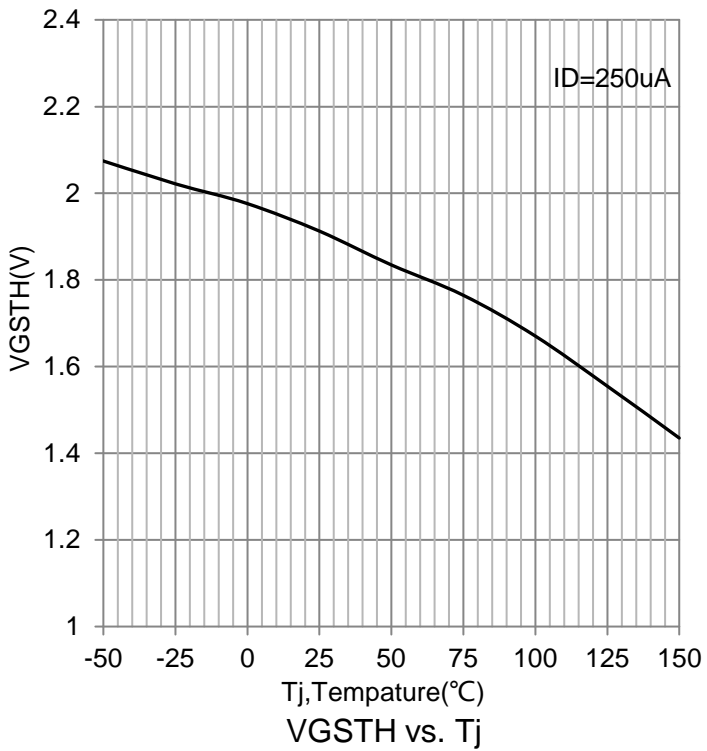
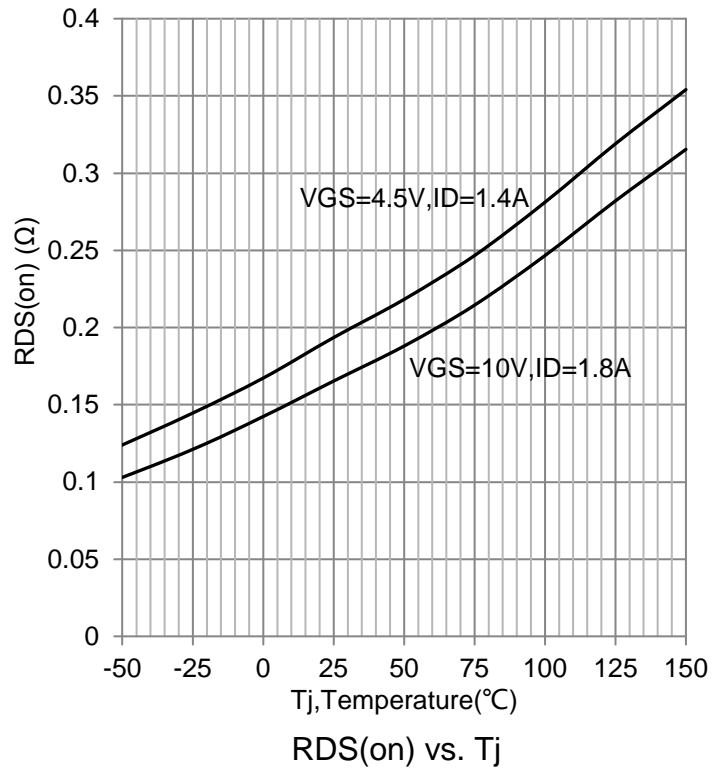
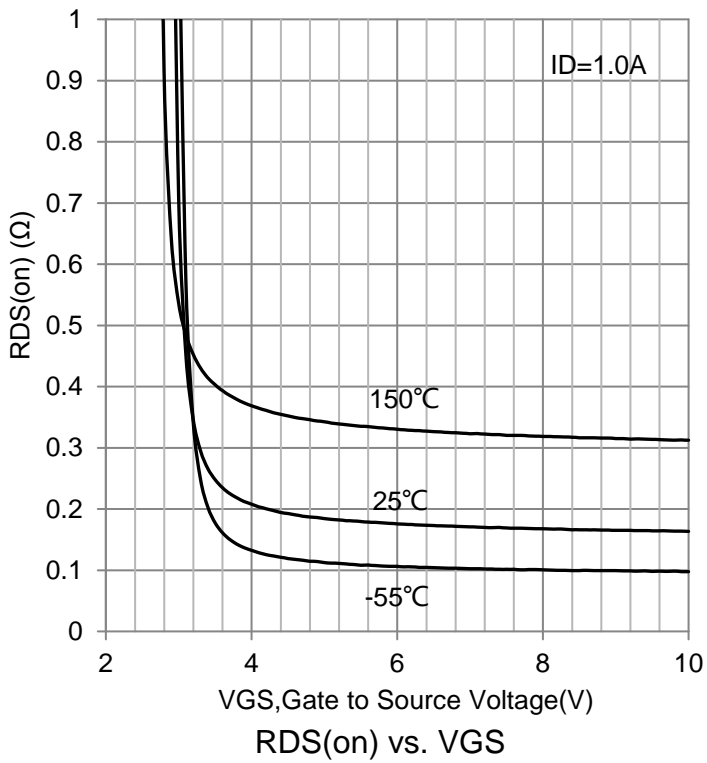

6.ELECTRICAL CHARACTERISTICS CURVES(Con.)

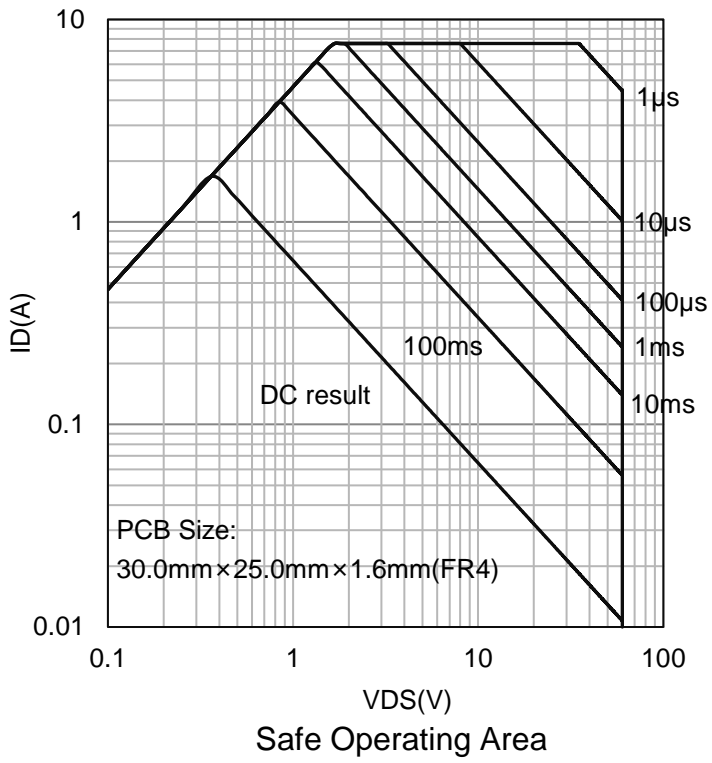

7. OUTLINE AND DIMENSIONS

Notes:

1. DIMENSIONING AND TOLERANCING PER ANSI Y14.5M, 1982.
2. CONTROLLING DIMENSION: MILLIMETERS.
3. MAXIMUM LEAD THICKNESS INCLUDES LEAD FINISH. MINIMUM LEAD THICKNESS IS THE MINIMUM THICKNESS OF BASE MATERIAL.
4. DIMENSIONS D AND E DO NOT INCLUDE MOLD FLASH, PROTRUSIONS OR GATE BURRS.

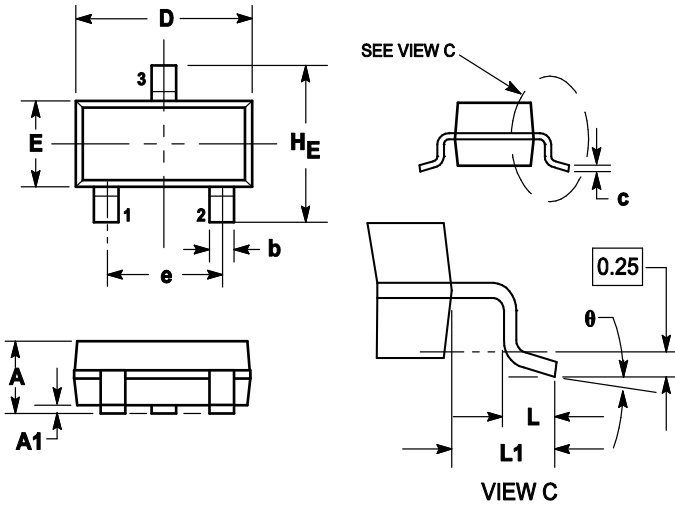

DIM	MILLIMETERS			INCHES		
	MIN	NOM	MAX	MIN	NOM	MAX
A	0.89	1	1.11	0.035	0.04	0.044
A1	0.01	0.06	0.1	0.001	0.002	0.004
b	0.37	0.44	0.5	0.015	0.018	0.02
c	0.09	0.13	0.18	0.003	0.005	0.007
D	2.80	2.9	3.04	0.11	0.114	0.12
E	1.20	1.3	1.4	0.047	0.051	0.055
e	1.78	1.9	2.04	0.07	0.075	0.081
L	0.10	0.2	0.3	0.004	0.008	0.012
L1	0.35	0.54	0.69	0.014	0.021	0.029
HE	2.10	2.4	2.64	0.083	0.094	0.104
θ	0°	---	10°	0°	---	10°

8. SOLDERING FOOTPRINT

